

Table of Contents

| Section 8010 - Traffic Signals | | Page No. |
|---------------------------------------|---------------------------------|-----------------|
| Part 1 - General | | |
| 1.01 | Section Includes | 1 |
| 1.02 | Description of Work | 1 |
| 1.03 | Submittals | 1 |
| 1.04 | Substitutions | 1 |
| 1.05 | Delivery, Storage, and Handling | 1 |
| 1.06 | Scheduling and Conflicts | 1 |
| 1.07 | Special Requirements | 2 |
| 1.08 | Measurement and Payment | 2 |
| Part 2 - Products | | |
| 2.01 | Underground | 3 |
| 2.02 | Detection | 6 |
| 2.03 | Communications | 8 |
| 2.04 | Cabinet and Controller | 10 |
| 2.05 | Poles, Heads, and Signs | 11 |
| Part 3 - Execution | | |
| 3.01 | Underground | 15 |
| 3.02 | Detection | 19 |
| 3.03 | Communications | 20 |
| 3.04 | Cabinet and Controller | 20 |
| 3.05 | Poles, Heads, and Signs | 21 |
| 3.06 | Temporary Traffic Signal | 22 |
| 3.07 | Surface Restoration | 22 |
| 3.08 | Testing | 22 |
| 3.09 | Documentation | 23 |

| Section 8010 - Traffic Signals (Continued) | Figure No. |
|---|-------------------|
| Figures | |
| Cabinet Footing Details | 8010.101 |
| Traffic Signal Pole Foundation | 8010.102 |
| Conduit and Precast Handholes | 8010.103 |
| Inductive Loop Vehicle Detectors | 8010.104 |
| Mast Arm Pole Details | 8010.105 |
| Pedestal Pole and Pedestrian Post Details | 8010.106 |
| Wood Post Span Assembly | 8010.107 |
| Section 8020 - Pavement Markings | Page No. |
| Part 1 - General | |
| 1.01 Section Includes | 1 |
| 1.02 Description of Work | 1 |
| 1.03 Submittals | 1 |
| 1.04 Substitutions | 2 |
| 1.05 Delivery, Storage, and Handling | 2 |
| 1.06 Scheduling and Conflicts | 2 |
| 1.07 Special Requirements | 2 |
| 1.08 Measurement and Payment | 2 |
| Part 2 - Products | |
| 2.01 Materials | 5 |
| Part 3 - Execution | |
| 3.01 Equipment | 6 |
| 3.02 Construction | 6 |

| Section 8030 - Temporary Traffic Control | Page No. |
|---|-------------------|
| Part 1 - General | |
| 1.01 Section Includes | 1 |
| 1.02 Description of Work | 1 |
| 1.03 Submittals | 1 |
| 1.04 Substitutions | 1 |
| 1.05 Delivery, Storage, Handling, and Salvaging | 1 |
| 1.06 Scheduling and Conflicts | 1 |
| 1.07 Special Requirements | 1 |
| 1.08 Measurement and Payment | 2 |
| Part 2 - Products | |
| 2.01 General | 3 |
| 2.02 Signs | 3 |
| 2.03 Channelizing Devices | 3 |
| 2.04 Miscellaneous Products | 4 |
| 2.05 Equipment | 4 |
| 2.06 Flaggers | 4 |
| Part 3 - Execution | |
| 3.01 Installation | 5 |
| 3.02 Maintenance | 5 |
| 3.03 Quality Control | 5 |
| Figures | Figure No. |
| Temporary Traffic Control General Information | 8030.101 |
| Work off of Pavement with Minor Encroachment onto Traveled Way | 8030.102 |
| Work in Center of Low Volume Street | 8030.103 |
| Lane Closure on Low Volume Street (Self-Regulating) | 8030.104 |
| Lane Closure for Short-Term or Moving Operations Using a Single Flagger | 8030.105 |
| Lane Closure on Two-Lane Road Using Two Flaggers | 8030.106 |
| Work in Vicinity of Roadway-Rail Grade Crossing | 8030.107 |

| Section 8030 - Temporary Traffic Control (Continued) | Figure No. |
|---|-------------------|
| Traffic Control for Outside Lane Closure of Street with Continuous Left Turn Lane | 8030.108 |
| Traffic Control for Closure of Continuous Left Turn Lane | 8030.109 |
| Lane Closure on Multi-Lane Street | 8030.110 |
| Lane Closure at an Intersection | 8030.111 |
| Lane Closure on the Far Side of an Intersection | 8030.112 |
| Closure of Turn Lane | 8030.113 |
| Closure in Center of Intersection | 8030.114 |
| Moving Operations on Two Lane Roads | 8030.115 |
| Street or Road Closure | 8030.116 |
| Sidewalk Detour | 8030.117 |
| Sidewalk Diversion | 8030.118 |
| Closure of Marked or Unmarked Crosswalk | 8030.119 |

TRAFFIC SIGNALS**PART 1 - GENERAL****1.01 SECTION INCLUDES**

- A. Underground
- B. Detection
- C. Communications
- D. Cabinet and Controller
- E. Poles, Heads, and Signs

1.02 DESCRIPTION OF WORK

This part of the specifications includes the furnishing of all material and equipment necessary to complete, in place and operational, traffic control signal(s) as described in the project plans.

1.03 SUBMITTALS

Comply with Division 1 - General Provisions and Covenants, as well as the additional requirements listed below. All of the following must be submitted within 30 days after awarding of the contract for the project. Verify the method of submittal with the Jurisdiction.

- A. Schedule of Unit Prices:** Submit a completed schedule of unit prices. Estimates of the work performed on the project will be made by the Jurisdiction and the unit costs will be used to prepare progress payments to the Contractor.
- B. Material and Equipment List:** Submit a completed list of materials and equipment to the Jurisdiction for written approval before any equipment or materials are ordered.
- C. Contractor Certification:** Submit the name(s) and contact information of the International Municipal Signal Association (IMSA) Level II Certified Traffic Signal Technician(s) working on the project and a copy of their IMSA certificate.
- D. Shop Drawings:** Submit shop drawings for traffic signal poles and structures to be furnished on the project. Submit catalog cuts and manufacturer's specifications for all items in the equipment list.

1.04 SUBSTITUTIONS

Comply with Division 1 - General Provisions and Covenants.

1.05 DELIVERY, STORAGE, AND HANDLING

Comply with Division 1 - General Provisions and Covenants.

1.06 SCHEDULING AND CONFLICTS

Comply with Division 1 - General Provisions and Covenants.

1.07 SPECIAL REQUIREMENTS

Comply with the current edition of the MUTCD as adopted by the Iowa DOT.

1.08 MEASUREMENT AND PAYMENT**A. Traffic Signal:**

1. **Measurement:** Lump sum item; no measurement will be made.
2. **Payment:** Payment will be at the lump sum price for traffic signal installation.

B. Temporary Traffic Signal:

1. **Measurement:** Lump sum item; no measurement will be made.
2. **Payment:** Payment will be at the lump sum price for temporary traffic signal installation.

PART 2 - PRODUCTS**2.01 UNDERGROUND****A. Handhole:****1. General:**

- a. **Cable Hooks:** Provide four galvanized steel cable hooks with a minimum diameter of 3/8 inch and a minimum length of 5 inches.
- b. **Granular Base:** Comply with the following gradations; however, the Engineer may authorize a change in gradation, subject to materials available locally at the time of construction.

| Sieve | Percent Passing |
|--------|-----------------|
| 2" | 100 |
| 1 1/2" | 80 to 90 |
| 1" | 15 to 20 |
| 3/4" | 0 to 0.5 |

- c. **Cover:** Include "TRAFFIC SIGNAL" as a message on the cover. Alternate messages may be required as specified in the contract documents.

2. Precast Concrete Handhole:

- a. **Pipe:** Comply with ASTM C 76. Minimum Class III, Wall B (Iowa DOT Class 2000D). Four, 8 inch knockouts (conduit entrance points) equally spaced around the handhole.
- b. **Casting:** Gray cast iron and certified according to requirements of AASHTO M 306 for a 16,000 pound proof-load (HS-20).

3. Composite Handhole and Cover: Composed of mortar consisting of sand, gravel, and polyester resin reinforced by a woven glass fiber mat or of resin mortar and fiberglass. Ensure the handhole and cover withstands a load of 20,000 pounds. Provide a skid resistant surface on the cover. Provide two 3/8-16 UNC stainless steel hex head bolts with washers.**B. Conduit:****1. General:**

- a. Furnish weatherproof fittings of identical or compatible material to the conduit. Use standard factory elbows, couplings, and other fittings.
- b. Use a manufactured conduit sealing compound that is readily workable material at temperatures as low as 30°F and will not melt or run at temperatures as high as 300°F.

2. Steel Conduit and Fittings:

- a. Comply with ANSI C80.1.
- b. Use weatherproof expansion fittings with galvanized, malleable iron, fixed and expansion heads jointed by rigid steel conduit sleeves. As an option, the fixed head may be integral with the sleeve, forming a one piece body of galvanized malleable iron.
- c. Provide steel bushings.

3. Plastic Conduit and Fittings:

- a. **PVC:**
 - 1) PVC Schedule 40 plastic conduit and fittings complying with NEMA TC-2 (pipe), NEMA TC-3 (fittings), and UL 651 for Schedule 40 heavy wall type.

2.01 UNDERGROUND (Continued)

- 2) Solvent welded, socket type fittings, except where otherwise specified in the contract documents.
 - 3) Threaded adaptors for jointing plastic conduit to rigid metal ducts.
 - 4) Provide bell end fittings or bushings.
- b. HDPE:**
- 1) Comply with ASTM F 2160 (conduit) and ASTM D 3350 (HDPE material), SDR 13.5.
 - 2) Use orange colored conduit.
 - 3) Continuous reel or straight pieces to minimize splicing.
 - 4) For dissimilar conduit connections, provide an adhesive compatible with both materials.
- C. Wiring and Cable:** Provide wire that is plainly marked on the outside of the sheath with the manufacturer's name and identification of the type of the cable.
1. **Power Cable:** Comply with Iowa DOT Article 4185.11.
 2. **Signal Cable:** Comply with IMSA Specifications 19-1 (PVC jacket) or 20-1 (polyethylene jacket) for polyethylene insulated, 600 volt, solid, multi-conductor copper wire, #14 American Wire Gauge (AWG).
 3. **Tracer Wire:** Comply with #10 AWG, single conductor, stranded copper, type thermoplastic heat and water resistant, nylon-coated (THWN), with UL approval, and an orange colored jacket.
 4. **Communications Cable:** Comply with IMSA Specifications 39-2 or 40-2 for #19 AWG, solid copper conductor, twisted pairs. Use polyethylene insulated, aluminum shielded, complying with REA Specification PE-39 for paired communication cable with electrical shielding.
 5. **Category 5E (Cat5E) Cable:** Provide outdoor use rated cable.
 6. **Fiber Optic Cable and Accessories:**
 - a. Furnish fiber optic cable of the mode type, size, and number of fibers specified in the contract documents, and all associated accessories.
 - b. Meet the latest applicable standard specifications by ANSI, Electronics Industries Association (EIA), and Telecommunications Industries Association (TIA).
 - c. Multimode Fiber:
 - Core Diameter: $62.5 \mu\text{m} \pm 1.0 \mu\text{m}$
 - Cladding Diameter: $125.0 \mu\text{m} \pm 1.0 \mu\text{m}$
 - Core Concentricity: $\pm 1\%$
 - Max. Attenuation: 3.50 dB/km @ 850 nm
 - d. Single-Mode Fiber:
 - Typical Core Diameter: $8.3 \mu\text{m} \pm 1.0 \mu\text{m}$
 - Cladding Diameter: $125.0 \mu\text{m} \pm 1.0 \mu\text{m}$
 - Core Concentricity: $\pm 1\%$
 - Attenuation Uniformity: No point discontinuity greater than 0.1 dB at either 1310 nm or 1550 nm
 - Max. Attenuation: 0.25 dB/km @ 1550 nm, 0.35 dB/km @ 1310 nm
 - e. Dual layer UV cured acrylate coating applied by the fiber manufacturer, mechanically or chemically strip-able without damage to the fiber.
 - f. Glass reinforced plastic rod central member designed to prevent the buckling of the cable. Cable core interstices filled with water blocking tape to prevent water infiltration. Dielectric fillers may be included in the cable core where needed to lend symmetry to the cable cross-section.

2.01 UNDERGROUND (Continued)

- g. Buffer tubes of dual layer construction with a polycarbonate inner layer and polyester outer layer. Each buffer tube filled with a water-swellable yarn or tape. Buffer tubes stranded around the central member using reverse oscillation or "SZ" stranding process. Gel-free cable and buffer tubes.
- h. Buffer tubes and fibers meeting TIA/EIA-598A, "Color coding of fiber optic cables," with 12 fibers per buffer tube.
- i. Cable tensile strength provided by a high tensile strength aramid yarn and/or fiber glass.
- j. All dielectric cables, without armoring, sheathed with medium density polyethylene (1.4 mm minimum nominal jacket thickness). Jacketing material applied directly over the tensile strength members and flooding compound. Jacket or sheath marked in a contrasting color with the manufacturer's name and the words "Optical Cable," the year of manufacture, and sequential meter or feet marks. Additionally, provide a durable weather proof label on the cable jacket showing the actual attenuation of each fiber expressed in dB/km.
- k. Cable fabricated to withstand a maximum pulling tension of 600 pounds during installation (short term) and 135 pounds upon installation (long term).
- l. Shipping, storing, and operating temperature range of the cable: -40° C to + 70° C. Installation temperature range of cable: -10° C to + 60° C.
- m. Each fiber of all fiber optic cable tested by manufacturer at the 100% level for the following tests:
 - Proof tested at a minimum load of 50 kpsi (350 Mpa)
 - Attenuation
- n. Meet the appropriate standard Fiber Optic Test Procedure for the following measurements:
 - Fluid Penetration
 - Compound Drip
 - Compressive Loading Resistance
 - Cyclic Flexing
 - Cyclic Impact
 - Tensile Loading and Bending
- o. Make cable ends available for testing. Seal cable ends to prevent moisture impregnation.
- p. Fiber Distribution Panel: Provide a fiber distribution panel capable of terminating a minimum of 24 fibers, or as specified in the contract documents.
- q. Fiber Optic Connectors:
 - 1) ST type connectors of ceramic ferrule and physical contact end finish to terminate multi-mode fibers to equipment.
 - 2) SC type connectors of ceramic ferrule and physical contact end finish to terminate single-mode fibers to equipment.
 - 3) ST or mechanical connectors not allowed for cable splices.
 - 4) Maximum attenuation per connector: 0.75 dB.
- r. Fiber Optic Jumpers/Patch Cords: For connections in the cabinet, provide factory-assembled duplex pigtail jumpers with dielectric strength member, durable outer jacket and ST or SC compatible connectors. Provide adequate length for connections and 2 feet minimum slack.
- s. Fiber Optic Breakout Kits: Provide breakout kits for separation and protection of individual fibers, with buffering tube and jacketing materials suitable for termination of the fiber and fiber optic connector.
- t. Splices/ Splice Enclosures: Fusion splice continuous fiber runs or branch circuit connections in splice enclosures as allowed or specified in the contract documents. Provide environmentally protected outside plant splice enclosures with adequate number of trays to splice all fibers. Maximum attenuation per splice: 0.3 dB.

2.01 UNDERGROUND (Continued)**D. Footings and Foundations:**

1. Use Class C structural concrete complying with Iowa DOT Section 2403.
2. Use uncoated reinforcing steel complying with Iowa DOT Section 4151.

E. Bonding and Grounding:

1. **Ground Rods:** Provide 5/8 inch by 8 foot copper clad, steel ground rod.
2. **Bonding Jumper or Connecting Wire:** Provide #6 AWG bare conductor, copper wire.

2.02 DETECTION

A. Inductive Loop Vehicle Detector: A detector consists of a conductor loop or series of loops installed in the roadway, lead-in (feeder) cable, and a sensor (amplifier) unit with power supply installed in a traffic signal controller cabinet.

1. **Cables:** All cables must be UL approved.
 - a. **Tube Loop Detector Cable:** Comply with IMSA Specifications 51-5.
 - b. **Preformed Loop Detector Cable:** As approved by the Engineer.
 - c. **Loop Detector Lead-in Cable:** Comply with IMSA Specifications 50-2.
2. **Detector Loop Sealant:**
 - a. Use a rapid cure, high viscosity, liquid epoxy sealant formulated for use in sealing inductive wire loops and leads embedded in pavement. Ensure the cured sealer is unaffected by oils, gasoline, grease, acids, and most alkalis.
 - b. Use a sealant complying with Iowa DOT Materials I.M. 491.18.
3. **Sensor (Amplifier) Unit:**
 - a. Use a sensor unit that is solid state, digital, providing detection channel(s) with an inductance range of 0 to 2,000 micro-henries. Output circuits of the sensor unit will be provided by relays. Vehicle presence will result in a continuous call indication.
 - b. Provide a sensor unit with the following qualities:
 - 1) Sensitivity adjustment to allow as a minimum the selection of high, medium, or low sensitivity.
 - 2) Be capable of providing reliable detection of all licensed motor vehicles.
 - 3) Provide an indicator light for visual indication of each vehicle detection.
 - 4) Will not require external equipment for tuning or adjustment.
 - 5) Provide operation in the pulse mode or presence mode. Ensure mode switch is readily accessible.
 - 6) Provide a self tuning system that is activated automatically with each application of power. Provide automatic and continuous fine tuning to correct for environmental drift of loop impedance.
 - 7) Provide for fail-safe operation (continuous call) in the event of detector loop failure.
 - 8) Ensure each detector channel will respond to a frequency shift in an increasing or decreasing value as occurs with temperature shifts in the pavement without requiring a locked call.
 - 9) Use detector units with delay and extension timing. The delay feature is selected and adjusted externally on the sensor unit housing. Digitally derived timing is selectable in 1 second increments from 0 to 30 seconds. Ensure delay timing inhibits detector output until presence has been maintained for the time selected. Restart delay timer at each new detection.

2.02 DETECTION (Continued)

- 10) Use a sensor unit capable of normal operation without interference and false calls between sensor units ("crosstalk") when installed in the physical environment of the controller cabinet and the electrical environment of the associated electronic equipment installed therein, including other detectors.

B. Pedestrian Push Button Detectors:**1. Assembly:**

- a. Ensure the entire assembly is weather tight, secure against electrical shock, withstands continuous hard usage.
- b. Provide a removable contact assembly mounted in a die cast aluminum case.
- c. Ensure contacts are normally open with no current flowing except at the moment of actuation.
- d. Ensure the contacts are entirely insulated from the housing and operating button with terminals for making connections.
- e. Provide housing with one outlet for 1/2 inch pipe.

2. Accessible Pedestrian Signals (APS) Push Button Stations:

- a. **Housing:** Die cast aluminum, weather tight, secure against electrical shock and withstands continuous hard usage.
- b. **Audible and Vibrotactile Features:** Audible walk indication tone, vibrotactile arrow, and locator tone complying with MUTCD.
- c. **Voice Messages:** As specified in the contract documents and per MUTCD.
- d. **Speaker:** Weatherproof with automatic volume adjustment to 5 dBA over ambient sound. Maximum volume 100 dB at 3 feet.
- e. **Push Button:** Nonrusting metal alloy, ADA compliant, 2 inch diameter with tactile arrow and 3 pounds maximum operational force.
- f. **Switch:** Solid state rated at 20 million operations minimum.
- g. **Program and Audio File Updates:** USB or Ethernet.
- h. **Operating Temperature:** -30 to + 165⁰F.

3. Solid State Pedestrian Push Buttons (non-APS):

- a. **Housing:** Die cast aluminum, weather tight, secure against electrical shock and withstands continuous hard usage.
- b. **Push Button:** Nonrusting metal alloy, ADA compliant, 2 inch diameter with 3 pounds maximum operational force.
- c. **Switch:** Solid state rated at 20 million operations minimum.
- d. **Operating Temperature:** -30 to + 165⁰F.

4. Signs: Furnish signs complying with MUTCD.**C. Video Detection Camera System:** Detects vehicles by processing video images and providing detection outputs to the traffic signal controller.**1. Video Detection System and Processors:**

- a. Processor to be card rack mounted or located within camera. Compatible with NEMA TS-1, TS-2, and Type 170 controllers and cabinets.
- b. Must be capable of the following:
 - 1) Shadow rejection without special hardware.
 - 2) Non-impaired operation under light intensity changes.
 - 3) Maintained operation during various weather conditions (e.g. rain, fog, snow).
 - 4) Anti-vibration, 5% rejection based on image change.
 - 5) Ability to select direction of flow parameters.
 - 6) Ability to properly detect directionally.
 - 7) Operate in presence mode with less than 4% error.

2.02 DETECTION (Continued)

- c. Provide user-defined detection zone programming via a graphical user interface (GUI) and any necessary equipment for future programming. Store detection zones in non-volatile memory.
- d. Comply with NEMA TS-1 and TS-2 environmental and physical standards with an operating temperature of -34°C to +60°C, and 0% to 95% relative humidity.
- e. Ensure a factory certified representative from the supplier provides on-site VDS programming and testing.

2. Video Cameras:

- a. Provide a charge-coupled device (CCD) image sensor with variable focus color or black and white lens providing a minimum of 4 to at least a 40 degree horizontal field of view.
- b. Equipped with internal thermostatically controlled heater and external sunshield.
- c. Meet NEMA-4 or NEMA-6P environmental standards.
- d. Use camera cable(s) meeting the manufacturer's recommendations. Provide a continuous run, without splices, from the camera to the controller cabinet.

D. Microwave Vehicle Detectors: Detects all vehicles moving within the field of detection at speeds from 2 to 80 mph.

1. Must be capable of the following:
 - a. Minimum detection range from 3 to 200 feet for all vehicles.
 - b. Pattern spread of the detection field no more than 16 degrees.
 - c. Self-tuning and capable of continuous operation over a temperature range of -35°F to 165°F.
 - d. Side-fire mount or overhead mount.
 - e. Detecting directional traffic and the direction user selectable.
2. Microprocessor based using Doppler microwave at an operating frequency of 10.525 GHz.
3. FCC certification and tested to the applicable FCC specifications.
4. Enclosure constructed of aluminum or stainless steel and water resistant.
5. All user operated controls and adjustments must be clearly marked and easily accessible.
6. Relay detection output to the controller with a minimum 5 amp rating and designed to place a constant call to the controller in the event of any failure.
7. Easily accessible indicator showing activation of detection relay.
8. Required wiring as recommended by the manufacturer.
9. Provide mounting hardware for the type of mounting specified in the contract documents and power supply equipment as recommended by the manufacturer.

2.03 COMMUNICATIONS

- A. Traffic Monitoring System:** Provide as specified in the contract documents including, video camera in dome, dome mounting bracket and hardware, camera controller, cabling from camera to controller cabinet, and all accessories and hardware necessary for a complete and operational system.

2.03 COMMUNICATIONS (Continued)

1. Pan/tilt/zoom (PTZ) color camera with automatic conversion to monochrome during low light levels, auto focus, auto-iris control, electronic image stabilization, privacy masking and high resolution 1/4 inch CCD imager. Minimum optical zoom: 25X. Minimum digital zoom: 12X.
 2. Camera system provided in a NEMA 4X or IP66 certified rugged weather-resistant package.
 3. Provide all required lightning protection for electronics control, power, and coax video outputs.
 4. Operating temperature range: -40°C to +50°C.
 5. Maximum cable length as specified by camera manufacturer.
 6. Provide full 360 degree endless pan and 220 degree tilt under PTZ control.
 7. Dome electronics capable of programming a minimum of 64 preset views and nine preprogrammed pattern sequences of preset views. All views selectable by the central office computer or a remote control device.
 8. Provide encoder and decoder devices as needed to transmit video over existing or proposed communication systems at 30 frames per second.
 9. Provide all necessary rack support devices for video viewing and PTZ control.
 10. Provide ability to control PTZ and view video remotely.
- B. Fiber Optic Hub Cabinet:** As specified in the contract documents.
- C. Wireless Interconnect Network:** Provides two-way data communication between the on-street master controller and local traffic signal controllers.
1. **Data Transceiver:**
 - a. Utilize a license-free spread spectrum radio frequency (902-928 MHz) with frequency hopping technology.
 - b. Completely programmable by software. Furnish software to the Jurisdiction.
 - c. Built-in diagnostics capabilities.
 - d. Configurable as master, slave, or repeater with store and forward capability.
 - e. Maintains user selectable power output levels between 0.1 and 1 watt.
 - f. Operates with input voltages between 6 VDC and 30 VDC.
 - g. RS-232 interface with 115.2 kbps capability.
 - h. Operating temperature of -40°C to +75°C.
 - i. Receiver sensitivity of -108 to -110 dBm at 10⁻⁶ BER.
 - j. Protected from power surges.
 - k. Rack or shelf mounted in controller cabinet and connections for antenna, power, and controller.
 2. **Antenna:**
 - a. Capable of transmitting and receiving data between intersections.
 - b. Mount near the top of the signal pole nearest the controller cabinet or as specified in the contract documents. Provide engineer-approved mounting hardware.
 - c. Connect to transceiver via appropriate cable from pole to signal cabinet in same conduit as traffic signal cable. Conceal cable within a watertight connection at antenna.

2.04 CABINET AND CONTROLLER

A. NEMA Controller, Cabinet, and Auxiliary Equipment: Comply with the latest edition of NEMA TS1 or TS2 standards.

1. Controller:

- a. Solid state modular design with digital timing and capable of accommodating at least eight phases.
- b. Fully prompted, front panel keyboard with menu driven programmability.
- c. Local time base scheduler including automatic accommodation for daylight savings time.
- d. Local coordination control.
- e. Local preemption control with at least four programmable internal preemption sequences.
- f. Current software and documentation.
- g. Data retained in a memory medium that does not require battery backup.

2. Cabinet:

- a. Unpainted aluminum cabinet according to NEMA standards.
- b. Aluminum cabinet riser with same dimensions as cabinet and 12 to 18 inch height, as specified in the contract documents.
- c. Police door with auto/flash switch, manual/stop time switch, and on/off power switch for signal heads only. Controller to remain in full operation regardless of switch positions.
- d. Maintenance panel on inside of the main door containing the following test switches.
 - 1) Controller power switch.
 - 2) Detector test switches.
 - 3) Stop time switch.
 - 4) Signal flash switch.
- e. Heavy-duty clear plastic envelope attached to inside wall of cabinet or cabinet door, for cabinet wiring diagrams, 12 inches by 18 inches minimum.
- f. GFI electrical outlet and lamp in accessible location near the front of the cabinet. GFI outlet fused separately from main AC circuit breaker. Fluorescent or LED cabinet lamp connected and fused with GFI outlet.
- g. Back panel positions to accommodate phasing and expansibility specified in the contract documents.
- h. Power protection devices including AC power circuit breakers, radio interference suppressors, and lightning and surge protectors.
 - 1) AC field service single pole, nonadjustable, magnetic breaker rated for 117 VAC operation, NEC approved.
 - 2) Radio interference suppressors (RIS) as required to minimize interference in all broadcast transmission and aircraft frequency bands.
 - 3) Lightning arrestor/surge protector capable of withstanding repeated (minimum of 25) 30,000 ampere surges.
- i. Neatly train wiring throughout the cabinet and riser. Bundle and attach wiring to interior panels using nonconductive clamps or tie-wraps.

3. Auxiliary Equipment: Conflict monitor/malfunction management unit, flasher, load switches, terminals and facilities, and miscellaneous equipment and materials according to NEMA standards.

B. Uninterruptible Power Supply Battery Backup System: Monitors 120VAC input from the electric utility source and automatically switches to/from a system consisting of batteries and electronics.

1. Include a maintenance bypass switch to allow operation of the traffic signal system while repairs are made to the battery backup system.
2. Designed to provide a minimum of 4 hours of normal operation.

2.04 CABINET AND CONTROLLER (Continued)

3. Use cabinet equipment that is plug connected and shelf mounted.
4. Designed to cover a temperature range from -30°F to +165°F and include a surge suppressor.

C. Emergency Vehicle Preemption System: As specified in the contract documents.

2.05 POLES, HEADS, AND SIGNS

A. Vehicle Traffic Signal Head Assembly: Comply with current MUTCD and ITE standards.

1. Housing:

- a. Individual signal sections made of a durable polycarbonate. Use color specified in the contract documents. Color to be an integral part of the materials composition.
- b. Self-contained unit capable of separate mounting or inclusion in a signal face containing two or more signal sections rigidly and securely fastened together.
- c. Equipped with openings and positive locking devices in the top and bottom so that it may be rotated between waterproof supporting brackets capable of being directed and secured at any angle in the horizontal plane.
- d. Doors and lenses with suitable watertight gaskets and doors that are suitably hinged and held securely to the body of the housing by simple locking devices of non-corrosive material. Doors are to be easily removed and reinstalled without use of special tools.

2. Optical System: Designed to prevent any objectionable reflection of sun rays even at times of the day when the sun may shine directly into the lens.

3. Lenses: 12 inch diameter polycarbonate. Do not use glass lenses.

4. Visors:**a. Standard Installation:**

- 1) Each signal lens is to have a visor with the bottom 25% open.
- 2) Minimum 0.1 inch in thickness and black in color.
- 3) Fits tightly against the housing door with no filtration of light between the visor and door.
- 4) Minimum length of 9 1/2 inches. Ensure the visor angle is slightly downward.

b. Optically Programmed Sections: Make sure the optical unit and visor are designed as a whole to eliminate the return of outside rays entering the unit from above the horizontal.

5. Terminal Block:

- a. Three-section signal equipped with a six position terminal block.
- b. Four- and five-section signal equipped with an eight position terminal block.

6. Backplate:

- a. Manufactured one-piece, durable, black plastic capable of withstanding a 100 mph wind.
- b. Provides 5 inches of black field around the assembly.

7. Mounting Hardware:

- a. **Fixed:** 1 1/2 inch aluminum pipe and fittings, natural aluminum finish for galvanized poles or match the pole color. Secure to pole with a minimum 5/8 inch wide stainless steel banding material.
- b. **Universally Adjustable:** Rigid mounted, consisting of both top and bottom brackets and easily adjustable in both horizontal and vertical planes.

8. LED Modules: Comply with current ITE standards.

2.05 POLES, HEADS, AND SIGNS (Continued)**B. Pedestrian Traffic Signal Head Assembly:** Comply with current MUTCD and ITE standards.**1. Housing:**

- a. Made of a durable polycarbonate. Use color specified in the contract documents. Color to be an integral part of the materials composition.
- b. Self-contained unit capable of separate mounting or inclusion in a signal face containing one or more signal sections rigidly and securely fastened together.
- c. Equipped with openings and positive locking devices in the top and bottom so that it may be rotated between waterproof supporting brackets capable of being directed and secured at any angle in the horizontal plane.
- d. Doors and lenses with suitable watertight gaskets and doors that are suitably hinged and held securely to the body of the housing by simple locking devices of non-corrosive material. Doors are to be easily removed and reinstalled without use of special tools.

2. Visor:

- a. Tunnel type visor attached to the housing door by stainless steel screws.
- b. Fit tightly against the housing door to prevent any filtration of light between the door and the visor.
- c. Ensure the visor angle is slightly downward.

3. LED Module:

- a. Provide a LED unit(s) for the filled upraised hand symbol, walking person symbol, and countdown timer.
- b. Ensure immediate blank out of the countdown timer display upon recognizing a shortened "Walk" or a shortened "Flashing Don't Walk" interval.

C. Traffic Signal Poles and Mast Arms:**1. General:**

- a. Use mast arm length and vertical pole height as specified in the contract documents.
- b. Ensure the mast arms, poles, and supporting bases are galvanized on both interior and exterior surfaces according to ASTM A 123.
- c. Use continuously tapered, round, steel poles of the transformer base type. Fabricate poles from low carbon (maximum carbon 0.30%) steel of U.S. standard gauge.
- d. When a transformer base is not specified, provide a 6 inch by 16 inch handhole in the pole shaft for cable access. Provide a cover for the handhole. Secure the cover to the base with simple tools. Use corrosion resistant hardware.
- e. Ensure minimum yield strength of 48,000 psi after manufacture. Supply base and flange plates of structural steel complying with ASTM A 36 and cast steel complying with ASTM A 27, Grade 65-35 or better.
- f. Where a combination street lighting/signal pole is specified in the contract documents, ensure the luminaire arm is mounted in the same vertical plane as the signal arm unless otherwise specified. Use a luminaire arm of the single member tapered type. Fabricate the pole with a minimum 4 inch by 6 inch handhole and cover located opposite the signal mast arm.
- g. If allowed by the Engineer, poles and mast arms may be fabricated by shop welding two sections together, resulting in a smooth joint as follows:
 - 1) Ensure a minimum of 60% penetration for longitudinal butt welds in plates 3/8 inch and less in thickness, except within 1 foot of a transverse butt-welded joint. Ensure a minimum of 80% penetration for longitudinal butt welds in plates over 3/8 inch in thickness.
 - 2) Ensure 100% penetration for longitudinal butt welds in poles and arms within 1 foot of a transverse butt-welded joint.

2.05 POLES, HEADS, AND SIGNS (Continued)

- 3) Ensure 100% penetration for transverse butt welds by using a back-up ring or bar to connect the sections.
 - 4) Examine the full length of all transverse butt welds and 100% penetration longitudinal butt welds by ultrasonic inspection according to the requirements of ANSI/AWS D1.1.
 - 5) Comply with ANSI/AWS D1.1 except as modified by Iowa DOT Article 2408.03, B.
 - h. Provide non-shrink grout (complying with Iowa DOT Materials I.M. 491.13) or a rodent guard (complying with Iowa DOT Materials I.M. 443.01) for placement between the pole base and the foundation.
- 2. Pole Design:** Comply with AASHTO 2013 Standard Specifications for Structural Supports for Highway Signs, Luminaires, and Traffic Signals. Use a 90 mph basic wind speed with a 50 year mean recurrence interval for strength design. Use Category II for fatigue design. Apply only natural wind gust loads (i.e. do not apply galloping loads, vortex shedding loads, or truck-induced gust loads) for fatigue design. Install vibration mitigation devices on all traffic signal pole mast arms over 60 feet in length as shown on the figures.
- 3. Hardware:**
- a. General:**
 - 1) Equip poles and mast arms with all necessary hardware and anchor bolts to provide for a complete installation without additional parts.
 - 2) Furnish each anchor bolt with one leveling nut, one anchoring nut, and one jam nut (if required) on the exposed end and one of the following on the embedded end: nut, nut and plate, or nut and anchor bolt assembly ring plate. Use anchor bolts, nuts, and washers that comply with Iowa DOT Materials I.M. 453.08.
 - b. Anchor Bolts:**
 - 1) Use straight full-length galvanized bolts.
 - 2) Comply with ASTM F 1554, Grade 105, S4 (-20°F).
 - 3) Threads are to comply with ANSI/ASME B1.1 for UNC thread series, Class 2A tolerance.
 - 4) The end of each anchor bolt intended to project from the concrete is to be color coded to identify the grade.
 - 5) Do not bend or weld anchor bolts.
 - c. Nuts:**
 - 1) Comply with ASTM A 563, Grade DH or ASTM A 194, Grade 2H.
 - 2) Use heavy hex.
 - 3) Use ANSI/ASME B1.1 for UNC thread series, Class 2B tolerance.
 - 4) Nuts may be over-tapped according to the allowance requirements of ASTM A 563.
 - 5) Refer to Section 8010, 3.05, B, 2 for tightening procedure and requirements.
 - d. Washers:** Comply with ASTM F 436 Type 1.
 - e. Galvanizing:** Galvanize entire anchor bolt assembly consisting of anchor bolts, nuts, and washers (and plates or anchor bolt assembly ring plate, if used) according to the requirements of ASTM B 695, Class 55 Type 1 or ASTM F 2329 with zinc bath temperature limited to 850°F. Galvanize entire assembly by the same zinc-coating process, with no mixed processes in a lot of fastener assemblies.

2.05 POLES, HEADS, AND SIGNS (Continued)**D. Traffic Signal Pedestal Poles:****1. Materials:**

- a. **Pedestal:** The height from the bottom of the base to the top of the shaft as specified in the contract documents.
- b. **Pedestal Shaft:** Schedule 80 with satin brush or spun finish aluminum tubing. Top of the shaft outer diameter to be 4 1/2 inches and provided with a pole cap. Supply base collar for poles with shaft lengths greater than 10 feet.
- c. **Pedestal Base:** Cast aluminum, square in shape, with a handhole.
 - 1) **Handhole:** Minimum of 6 inches by 6 inches and equipped with a cast aluminum cover that can be securely fastened to the base with the use of simple tools.
 - 2) **Base:** Minimum weight of 20 pounds with a four bolt pattern uniformly spaced on a 12 1/2 inch diameter bolt circle. Meet or exceed AASHTO breakaway requirements.
2. **Anchor Bolts:** Four 3/4 inch by 15 inch steel, hot dip galvanized anchor bolts complying with ASTM F 1554, Grade 36, with right angle bend at the bottom end, complete with all hardware required for installation.

E. Pedestrian Push Button Post:**1. Material:**

- a. **Post:** Standard weight (Schedule 40) pipe complying with ASTM F 1083, galvanized inside and out; 2 1/2 inches in diameter.
- b. **Cap:** Waterproof cap complying with ASTM F 626.
- c. **Anchor Bolts:** Four 1/2 inch by 24 inch steel, hot dip galvanized anchor bolts complete with all hardware required for installation.
- d. **Non-shrink Grout:** Comply with Iowa DOT Materials I.M. 491.13 or a rodent guard (complying with Iowa DOT Materials I.M. 443.01) for placement between the post base and the foundation.
- e. **Base Plate:** Provide a 5 inch square, 1/2 inch thick galvanized steel base plate with a 4 1/2 inch bolt circle.

F. Traffic Signs:

1. Comply with Iowa DOT Section 4186.
2. Use a universally adjustable mast arm mounted sign bracket.
3. Comply with MUTCD and the contract documents for the street name sign dimensions, letter height and font, and sheeting.

PART 3 - EXECUTION**3.01 UNDERGROUND****A. Handhole:****1. Locations:**

- a. Do not construct in ditch bottoms, low areas where ponding of water may occur, or where they will be subject to normal vehicular traffic.
- b. With Engineer approval, additional handholes may be placed, at no additional cost to the Contracting Authority, to facilitate the work.

2. Excavation: Excavate as necessary to accommodate the handhole and granular base.**3. Granular Base:** Install 8 inch thick granular base extending a minimum of 6 inches beyond the outside walls of the handhole.**4. Placement:**

- a. In paved areas, install the handhole at an elevation so the casting is level and flush with the pavement. In unpaved areas, install the handhole approximately 1 inch above the final grade.
- b. Verify ring placement. Invert rings when installed in paved areas.

5. Conduit:

- a. Remove knockouts as necessary to facilitate conduit entrance.
- b. Extend conduit into the handhole, through a knockout, approximately 2 inches beyond the inside wall. Conduit to slope down and away from the handhole.
- c. Place non-shrink grout (complying with Iowa DOT Materials I.M. 491.13) in the opening of the knockout area after placement of conduit.

6. Cable Hooks: Install cable hooks centered between the knockouts and the top of the handhole.**7. Backfill:** Place suitable backfill material according to Section 3010.**8. Casting:** Place the casting on the handhole. Ensure the final elevation meets the handhole placement requirements.**B. Conduit:****1. General:**

- a. Place conduit to a minimum depth of 30 inches and a maximum depth of 60 inches below the gutterline. When conduit is placed behind the curb, place to a minimum depth of 24 inches and a maximum depth of 48 inches below top of curb.
- b. Change direction at handholes or by bending, such that the conduit will not be damaged or its internal diameter changed. Ensure bends are uniform in curvature and the inside radius of curvature of any bend is no less than six times the internal diameter of the conduit.
- c. On the exposed ends of conduit, place bell-end fittings on PVC or HDPE conduit and bushings on steel conduit prior to installing cable. Extend all conduits a minimum of 2 inches and a maximum of 4 inches above the finished surface of any foundation, footing, or structural base.

3.01 UNDERGROUND (Continued)

- d. When it is necessary to cut and thread steel conduit, do not allow exposed threads. Ensure conduits and fittings are free from burrs and rough places. Clean, swab, and ream conduit runs before cables are installed. Use nipples to eliminate cutting and threading where short lengths of conduit are required. Coat damaged galvanized finish on conduit with zinc rich paint. Use only galvanized steel fittings with steel conduit.
- e. Pack conduit ends with a conduit sealing compound.

2. Trenched Installation:

- a. Place backfill in layers not to exceed 12 inches in depth with each layer thoroughly compacted before the next layer is placed. Ensure backfill material is free of cinders, broken concrete, or other hard or abrasive materials.
- b. Remove all surplus material from the public right-of-way as soon as possible.

3. Trenchless Installation:

- a. When placing conduit under pavements, use the trenchless installation methods described in Section 3020.
- b. If trenchless methods that compact soils in the bore path are used, provide sufficient cover to prevent heaving of overlying paved surfaces.
- c. Do not allow pits for boring to be closer than 2 feet to the back of curb, unless otherwise specified in the contract documents.

C. Wiring and Cable:

1. Where practical, follow color codes so that the red insulated conductor connects to the red indication terminal, yellow to yellow, and green to green. Ensure cables are properly labeled at the controller by durable labels, or other appropriate methods, attached to the cables. Label home runs for cables as follows: northwest corner is red, southeast corner is blue, northeast corner is green, and southwest corner is orange.
2. Install continuous runs of vehicle and pedestrian signal cables from the vehicle or pedestrian signal head to the handhole compartment of the signal pole base. Install continuous runs of vehicle and pedestrian signal cables from the handhole compartment of the signal pole base to the terminal compartment in the controller cabinet. Do not splice signal cables in underground handholes.
3. Install continuous runs for video detection and emergency vehicle preemption cables from the unit to the controller cabinet.
4. Install continuous runs of power lead-in cables from the service point to the meter socket and from the meter socket to the controller cabinet.
5. Install continuous detector cable from each detector loop to the first handhole adjacent to the loop. Ensure cables are properly labeled at the controller by durable labels, or other appropriate methods, attached to the cables. Install continuous homerun cable from the splice made in the first handhole to the terminal compartment in the controller cabinet. Attach the drain wire of the shielded cable to the ground in the controller cabinet.
6. Provide a minimum of 4 feet of additional cable at each handhole and loosely coil the extra cable on the handhole cable hooks. Provide a minimum of 2 feet of additional cable at each signal pole (measured from the handhole compartment in the pole to the end of the cable). Provide a minimum of 10 feet of additional cable at each controller base.
7. Pull cables through conduit using a cable grip designed to provide a firm hold upon the exterior covering of the cable or cables, and minimize dragging on the ground or pavement.

3.01 UNDERGROUND (Continued)

8. Install a tracer wire in all conduits with the exception of conduits between detector loops and handholes. Use a silicon-filled wire nut to splice the tracer wire in each handhole and at the controller to form a continuous run.
9. Fiber Optic Cable and Accessories:
 - a. Use a suitable cable feeder guide between the cable reel and the face of the conduit to protect the cable and guide the cable directly into the conduit off the reel. During the installation, carefully inspect cable jacket for defects. If defects are found, notify the Engineer prior to any additional cable being installed. Take care when pulling the cable to ensure the cable does not become kinked, crushed, twisted, snapped, etc.
 - b. Attach a pulling eye to the cable and use to pull the cable through the conduit. Use a pulling swivel to preclude twisting of the cable. Lubricate cable prior to entering the conduit with a lubricant recommended by the manufacturer. Use dynamometer or break away pulling swing to ensure the pulling tension does not exceed the specified force of 600 pounds or the cable manufacturer's recommendations, whichever is less. Do not allow the cable to twist, stretch, become crushed, or forced around sharp turns that exceed the bend radius or scar or damage the jacket. Manually assist the pulling of the cable at each pull point.
 - c. Do not pull cable through any intermediate junction box, handhole, pull box, pole base, or any other opening in the conduit unless specified in the contract documents. Install cable by pulling from handhole or controller cabinet to the immediate next downstream handhole or cabinet. Carefully store the remaining length of cable to be installed in the next conduit run(s) in a manner that is not hazardous to pedestrian or vehicular traffic, yet ensures that no damage to the cable occurs. Storage methods are subject to Engineer approval.
 - d. At each handhole, visibly mark or tag cable, "CITY (or COUNTY) FIBER OPTIC"
 - e. Secure cables inside controller cabinet so that no load is applied to exposed fiber strands.
 - f. Ensure the radius of the bend for static storage is no less than 10 times the outside diameter of the cable, or as recommended by the manufacturer. Ensure the radius of the bend during installation is no less than 15 times the outside diameter of the cable, or as recommended by the manufacturer.
 - g. Provide cable slack in each handhole, junction box, and cabinet as specified in the contract documents. Where handholes or junction boxes lack sufficient area for cable storage or bend radius requirements, provide equivalent additional slack in adjacent facilities. Coil and bind slack cable at three points around the cable perimeter and support in its static storage position.
 - h. Install fiber optic accessories according to the manufacturer's recommendations and as specified in the contract documents.
10. Fiber Optic Cable Field Testing: Provide for each fiber both on-reel testing prior to installation and final testing after installation using a high-resolution optical time domain reflectometer (OTDR). Conduct measurements for single-mode fibers at 1310 ± 30 nanometer wavelength. Conduct measurements for multimode fibers at 850 ± 30 nanometer wavelength. Record the identification, location, length, and attenuation measurements of each fiber, and furnish test reports to the Engineer. Replace any cable that fails testing, at no additional cost to the Contracting Authority.
 - a. On-reel Testing: Perform testing for attenuation and continuity using OTDR and a pigtail splice. Complete testing in one direction only. Acceptable test results will be within $\pm 3\%$ of factory-supplied attenuation measurements. Except for access to and test preparation of one end of the newly furnished cable, preserve the cable in its originally-shipped condition. Furnish test reports to the Engineer prior to installation.

3.01 UNDERGROUND (Continued)

- b. **Cable Segment Testing:** Perform an end-to-end attenuation test of each terminated fiber of each fiber optic cable. Perform testing using hand-held optical test sets. Include test results in documentation package provided to the Engineer at the conclusion of the project. Acceptable test results will not exceed the cumulative specified losses of the components. For example, at 850 nanometers, a one kilometer multimode fiber link with two splices and a connector on each end will not exceed 5.6 dB:

| | |
|----------------------------|---------------|
| 1.0 km x 3.5 dB/km: | 3.5 dB |
| 0.3 dB per splice x 2: | 0.6 dB |
| 0.75 dB per connector x 2: | <u>1.5 dB</u> |
| Maximum allowable loss: | 5.6 dB |

Repair or replace any cable segment that fails testing. Retest any repaired or replaced cable. Submit complete documentation of test results to the Engineer (hard copy or electronically).

- c. **Final System Testing:** After complete fiber optic system is installed and terminated, but prior to capping unused fibers, perform OTDR readings on all cables to ensure that each section is in compliance with the specifications. Provide copies of OTDR trace signatures for all fibers for all cable sections to the Engineer. Also provide test results for attenuation test for the installed fibers using the insertion loss procedure and the transmitter/receiver power level test and the continuity test.

D. Footings and Foundations:

1. **Excavation:** Excavate to the size, shape, and depth specified in the contract documents. Ensure the bottom of all foundations rest securely on firm undisturbed soil. Minimize over-excavation to ensure support and stability of the foundation.
2. **Foundation:** Provide a means for holding all of the following elements rigidly in place while the concrete is being placed.
 - a. **Forms:**
 - 1) Set the forms level or sloped to meet the adjacent paved areas.
 - 2) When adjacent to paved areas, shape the top 11 inches of the foundation to be square and flush with the surrounding paved area. Provide preformed expansion material between the foundation and paved areas.
 - 3) When installed in an unpaved area, set the top of the foundation 2 inches above the surface of the ground.
 - b. **Reinforcing Steel:** Install reinforcing steel.
 - c. **Conduit:** Install conduit.
 - d. **Anchor Bolts:**
 - 1) Set anchor bolts using a template constructed to accommodate the specified elevation, orientation, and spacing according to the pole and controller manufacturer's requirements.
 - 2) Center the pole anchor bolts within the concrete foundation.
 - 3) Protect the anchor bolts until poles are erected.
 - 4) Orient controller footing with the back of the cabinet toward the intersection such that the signal heads can be viewed while facing the controller, unless otherwise directed by the Engineer.
 - e. **Concrete:**
 - 1) Place concrete to form a monolithic foundation. Consolidate concrete by vibration methods.
 - 2) Finish the top of the base level and round the top edges with an edging tool having a radius of 1/2 inch. Provide a rubbed surface finish on the exposed surface of the footing or foundation.

3.01 UNDERGROUND (Continued)

- 3) Allow the foundation to cure a minimum of 4 days prior to erecting the poles and 7 days prior to installing the mast arms. Times may be shortened if supported by strength test results.

3. Backfill: Place suitable backfill material according to Section 3010.

E. Bonding and Grounding:

1. Ensure the traffic signal installation is grounded as required by the National Electric Safety Code.
2. Install a ground rod at each signal pole foundation and controller footing.
3. Use PVC conduit within the foundation or footing to accommodate the connection between the top of the concrete and the ground rod.
4. Bond poles to ground rods with copper wire. Connect ground wires to ground rods with approved mechanical connectors.
5. Bond rigid steel conduit ends in handholes with copper wire and approved fittings.

3.02 DETECTION**A. Detector Loop Cable Installation:**

1. Coordinate the location of the detector loop with the Engineer. Obtain the Engineer's approval prior to cutting the pavement.
2. Saw to ensure proper depth and alignment of the slot. Make a 2 inch deep clean, straight, well-defined 3/8 inch wide saw cut without damage to adjacent areas. Overlap the saw cuts where the detector loop changes direction to provide full depth at all corners. Do not use right angle or corners less than 90 degrees.
3. Before installing the detector loop cable, check the saw cuts for the presence of jagged edges or protrusions and remove if present. Clean and dry the saw cuts to remove cutting dust, grit, oil, moisture, or other contaminants. Clean by flushing with a stream of water under pressure. Use oil-free compressed air to dry the saw cuts.
4. Install detector loop cable without damage. Place three turns of the detector loop cable into the saw cut. Seal the ends of the tubing at the time of placement to prevent entrance of moisture.
5. Ensure the detector loop cables are in the bottom of the saw cut. Place detector loop sealant within the saw cut area. Comply with the manufacturer's instructions for mixing and using the detector loop sealant.
6. Install preformed loop detector according to the manufacturer's recommendations.
7. Identify each detector loop cable in the handhole by phase and location. Wind loops that are physically adjacent in an individual lane or adjacent lanes with opposite rotation (i.e. #1 clockwise, #2 counter-clockwise, #3 clockwise, etc.). Rotation reversal can be accomplished by reversing leads at the handhole.
8. Twist, with at least five turns per foot, all lengths of loop wires and tubing that are not embedded in the pavement.

3.02 DETECTION (Continued)

9. Identify all detector loop lead-in cables with appropriate detector numbers.
10. Use a detector loop cable splice kit for the electrical splice between the detector loop cable and the detector loop lead-in cable to the controller.
 - a. Ensure splice kit provides a watertight protective covering for the spliced wire, the shielding on the detector loop lead-in cable, and the end of the tubing containing the detector loop cable.
 - b. Use a manufactured electrical splice kit approved by the Engineer.
11. Test all loops and document by using the following procedures:
 - a. Determine the insulation resistance of the loop wire using a "megger" with 500V applied to either loop wire to earth ground. The resistance is to be greater than 100 megohms.
 - b. Determine the inductance of the loop using a loop inductance meter.

B. Pedestrian Push Button Detectors:

1. Install according to the manufacturer's recommendations.
2. Seal the wire entrance into the pedestrian push button assembly.

C. Video Detection Camera System: Install according to the manufacturer's recommendations and as specified in the contract documents.**3.03 COMMUNICATIONS****A. Traffic Monitoring System:** Install according to the manufacturer's recommendations and as specified in the contract documents, as well as the following:

1. Position camera dome on the pole as directed by the Engineer.
2. Test installed system under the supervision of the Engineer, and certify as fully-functional.

B. Fiber Optic Hub Cabinet: Install according to the manufacturer's recommendations and as specified in the contract documents.**3.04 CABINET AND CONTROLLER****A. Controller, Cabinet, and Auxiliary Equipment:**

1. Install according to the manufacturer's recommendations and as specified in the contract documents.
2. Install on pre-placed caulking material on the concrete base. After the cabinet is installed in place, place caulking material around the base of the cabinet.

B. Controller: Install according to the manufacturer's recommendations and as specified in the contract documents.**C. UPS Battery Backup System:** Install according to the manufacturer's recommendations and as specified in the contract documents.**D. Emergency Vehicle Preemption System:** Install according to the manufacturer's recommendations and as specified in the contract documents.

3.05 POLES, HEADS, AND SIGNS**A. Vehicle and Pedestrian Traffic Signal Heads:**

1. Inspect each signal head assembly while still on the ground for the following:
 - a. Physical defects
 - b. Visor type
 - c. LED wattage
 - d. Lens orientation
 - e. Wiring connections
2. Attach signal head mounting hardware according to the manufacturer's recommendations. Apply anti-seize compound to all mechanical fasteners.
3. Adjust each signal head both vertically and horizontally to approximate a uniform grade of all like signal heads.
4. During the course of construction and until the signals are placed in operation, cover signal faces or turn away from approaching traffic. When ready for operation, plumb and aim the heads.

B. Traffic Signal and Pedestal Poles and Pedestrian Push Button Posts:

1. Erect all poles and posts vertically under normal load.
2. Securely bolt the bases to the cast-in-place concrete foundations using the following procedures. Perform this work only on days with winds less than 15 mph. Tighten all of the nuts in the presence of the inspector. Once the tightening procedure is started, complete on all of the base plate nuts without pause or delay.
 - a. Use properly sized wrenches or sockets, or both, designed for tightening nuts or bolts, or both, to avoid rounding or other damage to the nuts. Do not use adjustable end or pipe wrenches.
 - b. Ensure base plates, anchor rods, and nuts are free of all dirt or debris.
 - c. Apply stick wax or bees wax to the threads and bearing surfaces of the anchor bolt, nuts, and washers.
 - d. Tighten top nuts so they fully contact the base plate. Tighten leveling nuts to snug tight condition. Snug tight is defined as the full effort of one person on a wrench with a length equal to 14 times the bolt diameter but not less than 18 inches. Apply full effort as close to the end of the wrench as possible. Perform tightening by leaning back and using entire body weight to pull firmly on the end of the wrench until the nut stops rotating. Perform a minimum of two separate passes of tightening. Sequence tightening in each pass so that the nut on the opposite side, to the extent possible, is subsequently tightened until all of the nuts in that pass have been tightened.
 - e. Tighten top nuts to snug tight as described for the leveling nuts.
 - f. Match-mark the top nuts and base plate using paint, crayon, or other approved means to provide a reference for determining the relative rotation of the nut and base plate during tightening. Further tighten the top nuts tightened in two passes, as listed in Table 8010.01, using a striking or hydraulic wrench. Follow a sequence of tightening in each pass so that the nut on the opposite side, to the extent possible, is subsequently tightened until all nuts in that pass have been turned. Do not allow the leveling nut to rotate during the top nut tightening.
 - g. Lubricate the jam nuts, place, and tighten to snug tight.

3.05 POLES, HEADS, AND SIGNS (Continued)**Table 8010.01: Bolt Tightening**

| Anchor Bolt Size | First Pass | Second Pass | Total Rotation |
|---|-------------------|--------------------|-----------------------|
| Less than or equal to 1 1/2 inch diameter | 1/6 turn | 1/6 turn | 1/3 turn |
| Greater than 1 1/2 inch diameter | 1/12 turn | 1/12 turn | 1/6 turn |

3. A torque wrench should be used to verify that a torque at least equal to the computed verification torque, T_v , according to paragraph 6.9 of FHWA *Guidelines for the Installation, Inspection, Maintenance, and Repair of Structural Supports for Highway Signs, Luminaires, and Traffic Signals*, is required to additionally tighten the top nuts. An inability to achieve this torque should be interpreted to indicate that the threads have stripped and should be reported to the Engineer.
 4. After leveling the poles, use non-shrink grout or a rodent guard between the pole base and the foundation. When non-shrink grout is used, neatly finish exposed edges of grout to present a pleasing appearance, and place a weep hole in the grout.
 5. Apply anti-seize compound to all mechanical fasteners on pole access doors.
 6. Install pedestrian push button post caps with tamper-proof set screws per manufacturer's direction or by driving the cap a minimum of 1/2 inch onto the post.
- C. Traffic Signs:** Install signs using universally adjustable sign brackets banded to the pole. Apply anti-seize compound to all mechanical fasteners.

3.06 TEMPORARY TRAFFIC SIGNAL

Construct according to Figure 8010.107 and to the configuration specified in the contract documents.

3.07 SURFACE RESTORATION

- A. Replace or reconstruct features removed as a part of the work, such as sidewalks, driveways, curbs, roadway pavement, unpaved areas, or any other items.
- B. Complete restoration according the applicable sections of the SUDAS Standard Specifications or as directed by the Engineer.

3.08 TESTING

- A. Notify the Engineer 48 hours in advance of the time and date the signal or signal system will be ready for turn on. Do not turn on the signal or signal system without authorization of the Engineer.
- B. Ensure a representative from the manufacturer and/or supplier of signal controller or other authorized person is at the project site when the signal controllers are ready to be turned on to provide technical assistance including, as a minimum, programming of all necessary input data.
- C. All required signal timing data will be provided by the Engineer.

3.08 TESTING (Continued)

- D. A test period of 30 calendar days will start upon confirmation from the Engineer that the signal or signal system is operating consistent with the project requirements. Any failure or malfunction of the equipment furnished by the Contractor, occurring during the test period will be corrected by the Contractor at no additional cost to the Contracting Authority. Upon confirmation by the Engineer that any failure or malfunction has been corrected, a new test period of 30 calendar days will start, exclusive of minor malfunctions such as lamp burnouts. Repeat this procedure until the signal equipment has operated satisfactorily for 30 consecutive calendar days.
- E. After signal turn on and prior to completion of the 30 calendar day test period, respond, within 24 hours, to perform maintenance or repair of any failure or malfunction reported.

3.09 DOCUMENTATION

- A. Provide file documentation packages with each signal system, consisting of the following:
 - 1. Complete cabinet wiring diagram.
 - 2. Complete physical description of the equipment.
 - 3. Controller printout or equal documentation of initial controller settings installed in the field or in the office.
 - 4. Product manuals for all cabinet equipment.
 - 5. Standard industry warranties on equipment supplied.
 - 6. Documentation of field cable labeling scheme.
 - 7. Diagram of phasing and detector locations.
 - 8. One set of as-built construction plans indicating changes from the original contract documents.
- B. Supply two complete sets of documentation. One set to be placed in the controller cabinet and the other set (less construction plan) to be delivered to the Engineer.

END OF SECTION

- ① Shape top 11 inches with forms.
- ② Bolt spacing and conduit locations as specified by the manufacturer.

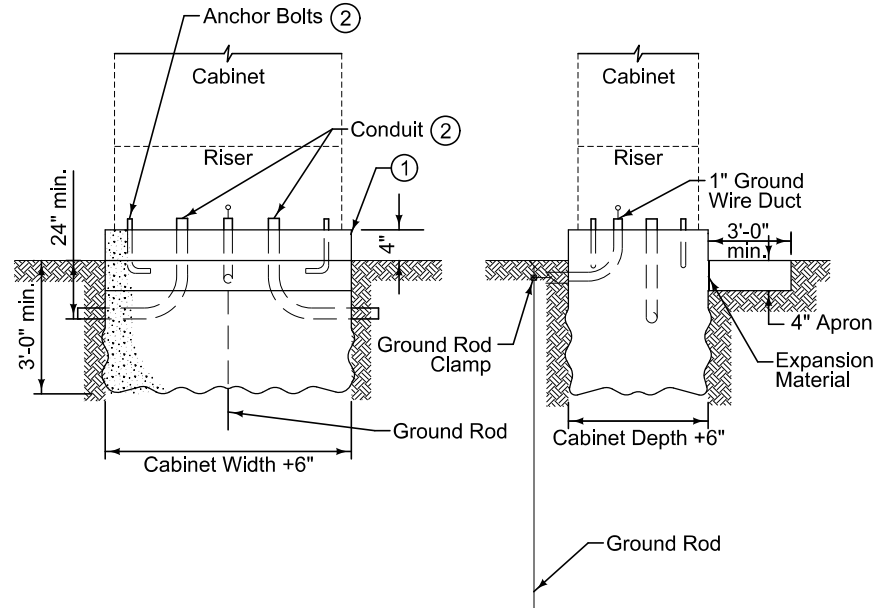

NEMA CONTROLLER CABINET FOOTING

| | |
|---|----------------|
|  | REVISION |
| | New 10-16-12 |
| | 8010.101 |
| SHEET 1 of 1 | |

SUDAS Standard Specifications

CABINET FOOTING
DETAILS

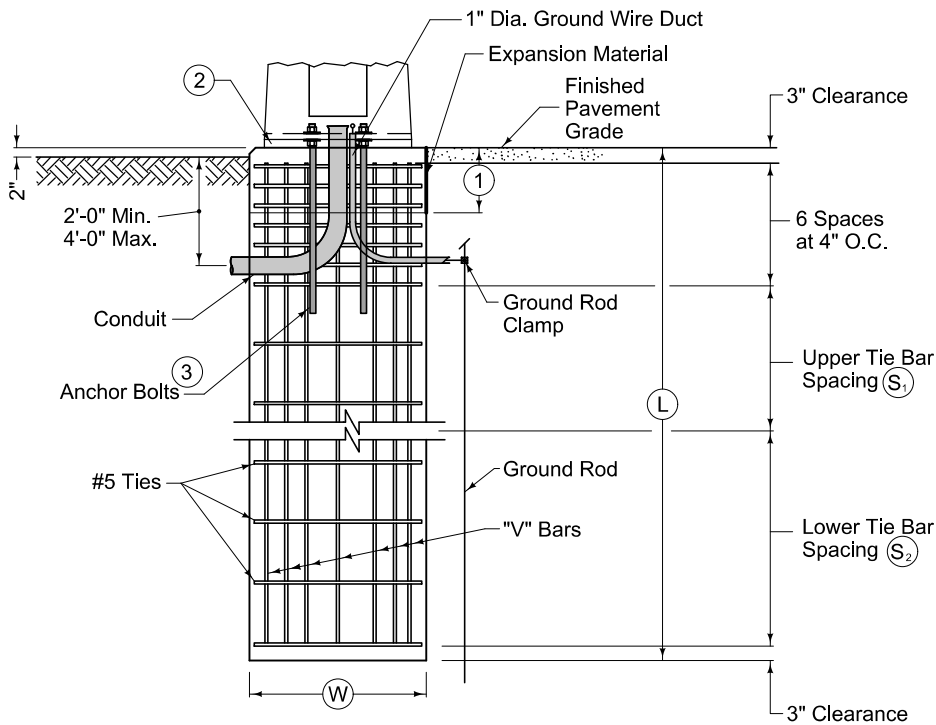

**MAST ARM POLE FOUNDATION IN SOIL
TYPE A FOUNDATION**

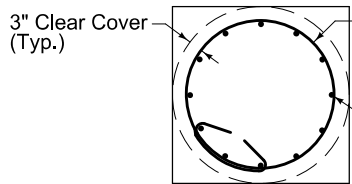

PLAN VIEW

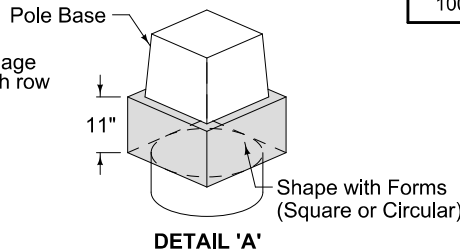

DETAIL 'A'

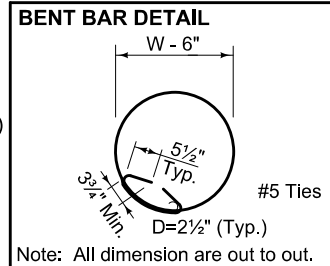

Note: All dimension are out to out.

The Type A Foundation is the normally required foundation construction. Where rock is encountered, the Engineer may approve the use of the Type B or C Foundation. Prior to installing a foundation in rock, obtain a subsurface investigation certified by a geotechnical engineer licensed in the State of Iowa.

- ① Shape top 11 inches with forms. See Detail 'A'.
- ② Install rodent guard or non-shrink grout with weep hole.
- ③ Furnish nut, nut and plate, or nut and anchor bolt assembly ring plate on embedded end.

| Max. Mast Arm Length | Foundation | | "V" Bars | | | Tie Bars | | | | |
|----------------------|------------|--------|----------|------|--------|----------|---------------|----------------|---------------|----------------|
| | W | L | Count | Size | Length | Count | Upper Spacing | | Lower Spacing | |
| | | | | | | | # Spaces | S ₁ | # Spaces | S ₂ |
| 35'-0" | 3'-0" | 12'-0" | 12 | #8 | 11'-6" | 17 | 9 | 12" | N/A | N/A |
| 45'-0" | 3'-0" | 14'-0" | 12 | #8 | 13'-6" | 19 | 11 | 12" | N/A | N/A |
| 55'-0" | 3'-0" | 16'-0" | 12 | #8 | 15'-6" | 25 | 12 | 8" | 5 | 12" |
| 60'-0" | 3'-0" | 18'-0" | 13 | #8 | 17'-6" | 28 | 15 | 8" | 5 | 12" |
| 70'-0" | 3'-6" | 18'-0" | 12 | #10 | 17'-6" | 28 | 15 | 8" | 5 | 12" |
| 80'-0" | 3'-6" | 21'-0" | 14 | #10 | 20'-6" | 40 | 22 | 6" | 10 | 8" |
| 90'-0" | 4'-0" | 22'-0" | 16 | #10 | 21'-6" | 42 | 24 | 6" | 10 | 8" |
| 100'-0" | 4'-0" | 24'-0" | 18 | #10 | 23'-6" | 47 | 32 | 6" | 7 | 8" |

| | | |
|---|--------------------|-----------------------------|
| SUDAS | IOWADOT | REVISION |
| | | 3 04-16-19 |
| FIGURE 8010.102 | STANDARD ROAD PLAN | TS-102 |
| | | SHEET 1 of 4 |
| REVISIONS: Added Detail 'A' on Sheets 1, 3, and 4. Modified table on Sheet 3. | | |
| SUDAS DIRECTOR | | DESIGN METHODS ENGINEER |
| TRAFFIC SIGNAL POLE FOUNDATION | | |

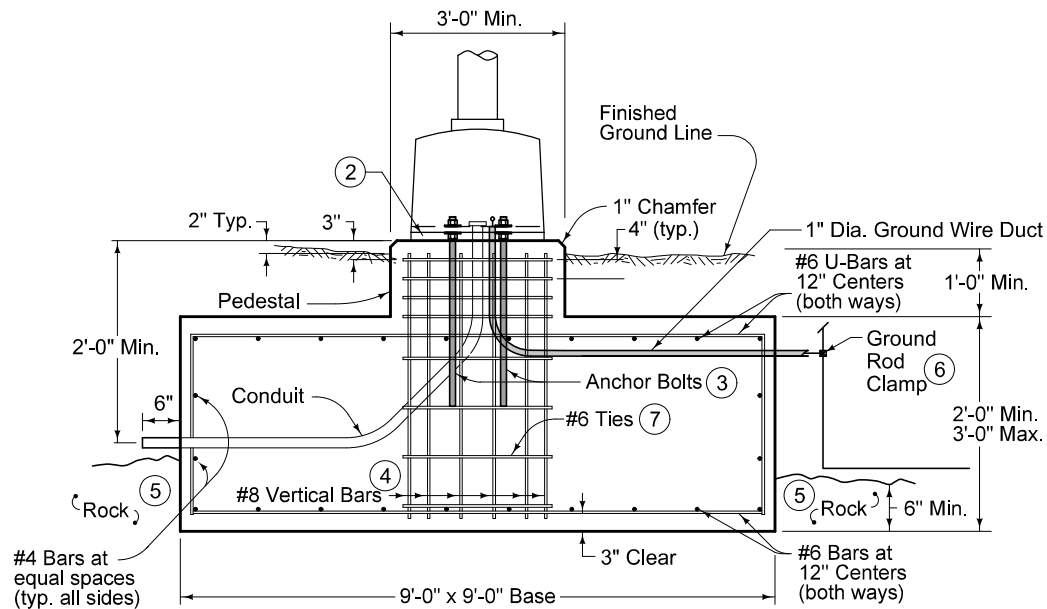

**MAST ARM POLE FOUNDATION IN ROCK
TYPE B FOUNDATION**

Type B Foundation is applicable for traffic signal poles with mast arm lengths up to 60 feet.

If the excavation for a Type B Foundation is left open for more than 1 calendar day, install temporary barrier rail if any part of the excavation is located within the clear zone. Temporary barrier rail layout requires the Engineer's approval.

Competent rock has an average unconfined compressive strength (q_u) of at least 2.0 ksi and rock quality designation of at least 90%. Conditions not meeting minimum requirements will require either:

- A site specific design, or
- Using the parameters for Mast Arm Pole Foundation in Soil.

- ② Install rodent guard or non-shrink grout with weep hole.
- ③ Furnish nut, nut and plate, or nut and anchor bolt assembly ring plate on embedded end.
- ④ Place 13 equally spaced #8 vertical bars.
- ⑤ Cast foundation concrete against competent rock. If foundation is formed, place backfill with concrete cast against rock.
- ⑥ When in contact with rock, place ground rods as specified in National Electrical Code, current edition.
- ⑦ #6 bars spaced at 8 inch maximum. Ties may be welded to vertical bars.

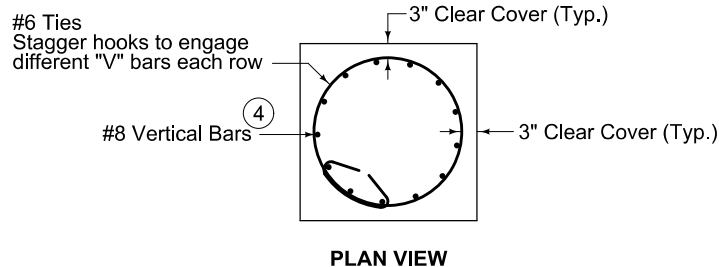

PLAN VIEW

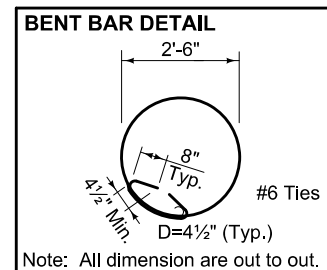

Note: All dimension are out to out.

| | | |
|---|--------------------|--|
| SUDAS | IOWADOT | REVISION |
| | | 3 04-16-19 |
| FIGURE 8010.102 | STANDARD ROAD PLAN | TS-102 |
| REVISIONS: Added Detail 'A' on Sheets 1, 3, and 4. Modified table on Sheet 3. | | SHEET 2 of 4 |
| Paul D. Wigand SUDAS DIRECTOR | | Stuart Nadeau DESIGN METHODS ENGINEER |
| TRAFFIC SIGNAL POLE FOUNDATION | | |

- ① Shape top 11 inches with forms. See Detail 'A'.
- ② Install rodent guard or non-shrink grout with weep hole.
- ③ Furnish nut, nut and plate, or nut and anchor bolt assembly ring plate on embedded end.
- ⑧ When in contact with rock, place ground rods as specified in National Electrical Code, current edition.

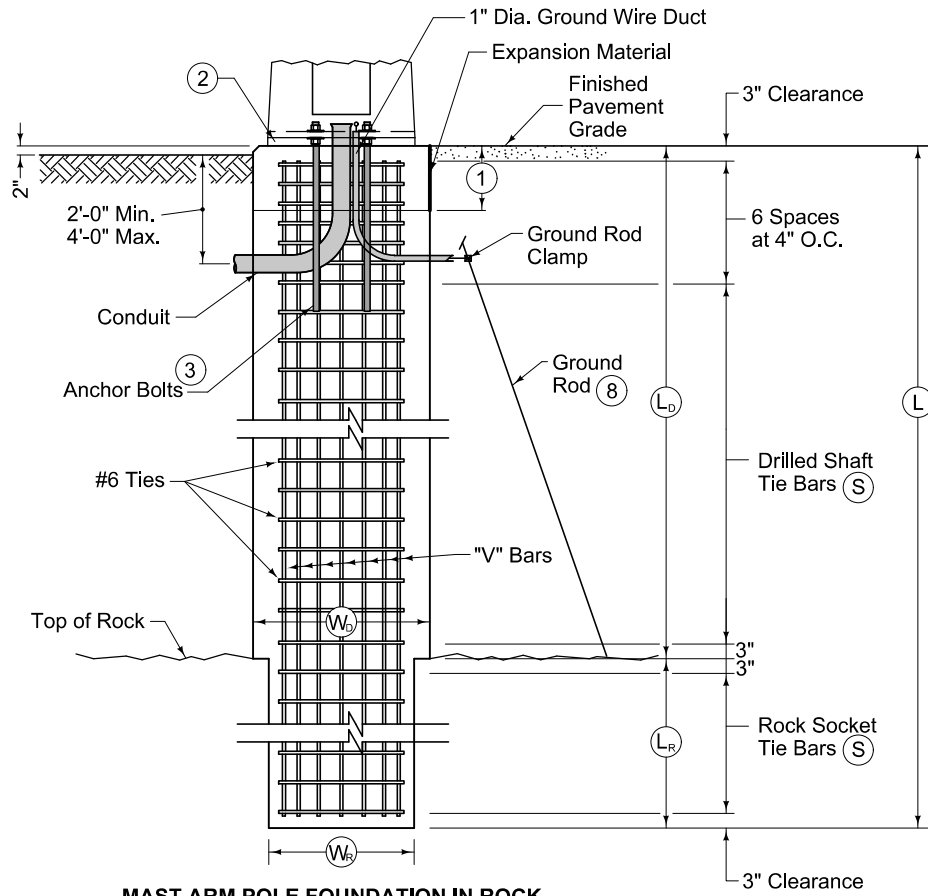

| Max. Mast Arm Length | Foundation | | | | | "V" Bars | | | Tie Bars | |
|----------------------|------------|---------|--------|---------------------------------|---------|----------|------|--------|------------------|-----|
| | (W_b) | (W_b) | (L) | (L_b) | (L_r) | Count | Size | Length | (S) Spacing | |
| | Min. | Min. | Max. | Broken Rock* / Competent Rock** | | | | | | |
| 35'-0" | 3'-0" | 2'-6" | 12'-0" | VARIES $L_0 = (L - L_r)$ | 4'-6" | 3'-0" | 13 | #8 | L - 6" | 6" |
| 45'-0" | 3'-0" | 2'-6" | 14'-0" | | 4'-6" | 3'-0" | 13 | #8 | L - 6" | 6" |
| 55'-0" | 3'-0" | 2'-6" | 16'-0" | | 4'-6" | 3'-0" | 13 | #8 | L - 6" | 6" |
| 60'-0" | 3'-0" | 2'-6" | 18'-0" | | 4'-6" | 3'-0" | 13 | #8 | L - 6" | 6" |
| 70'-0" | 3'-6" | 3'-0" | 18'-0" | | 5'-6" | 3'-6" | 14 | #9 | L - 6" | 5½" |
| 80'-0" | 3'-6" | 3'-0" | 21'-0" | | 5'-6" | 3'-6" | 14 | #9 | L - 6" | 5½" |
| 90'-0" | 4'-0" | 3'-6" | 22'-0" | | 6'-0" | 4'-0" | 15 | #10 | L - 6" | 5½" |
| 100'-0" | 4'-0" | 3'-6" | 24'-0" | | 6'-0" | 4'-0" | 15 | #10 | L - 6" | 5½" |

*Broken rock has an average unconfined compressive strength (q_u) of at least 1.0 ksi and rock quality designation of at least 20%.
 **Competent rock has an average unconfined compressive strength (q_u) of at least 2.0 ksi and rock quality designation of at least 90%.
 ***Total foundation length L must be sufficient to provide a 3 inch clearance between the bottom of the traffic signal pole anchor bolts and the bottom of the rock socket.
 ****The Rock Socket Length L_r can be decreased if the total length of the shaft is L long as shown in the table.
 Conditions not meeting minimum requirements will require site specific designs or shall use the Type A Foundation Soil parameters.

**MAST ARM POLE FOUNDATION IN ROCK
TYPE C FOUNDATION**

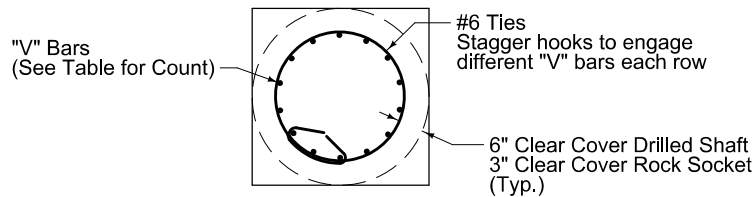

MAST ARM POLE FOUNDATION

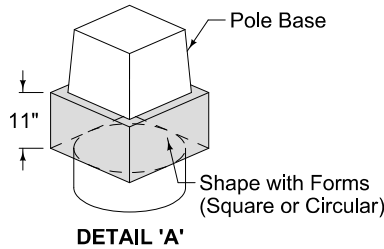

DETAIL 'A'

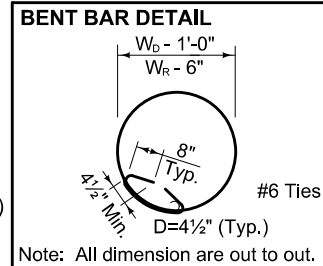

Note: All dimension are out to out.

FIGURE 8010.102 SHEET 3 OF 4

| | | | |
|---|--------------------|---|----------|
| SUDAS | IOWADOT | REVISION | |
| | | 3 | 04-16-19 |
| FIGURE 8010.102 | STANDARD ROAD PLAN | TS-102 | |
| | | SHEET 3 of 4 | |
| REVISIONS: Added Detail 'A' on Sheets 1, 3, and 4. Modified table on Sheet 3. | | | |
| Paul D. Wigand SUDAS DIRECTOR | | Shawn Miller DESIGN METHODS ENGINEER | |
| TRAFFIC SIGNAL POLE FOUNDATION | | | |

- ① Shape top 11 inches with forms. See Detail 'A'.
- ② Install rodent guard or non-shrink grout with weep hole.
- ③ Furnish nut, nut and plate, or nut and anchor bolt assembly ring plate on embedded end.

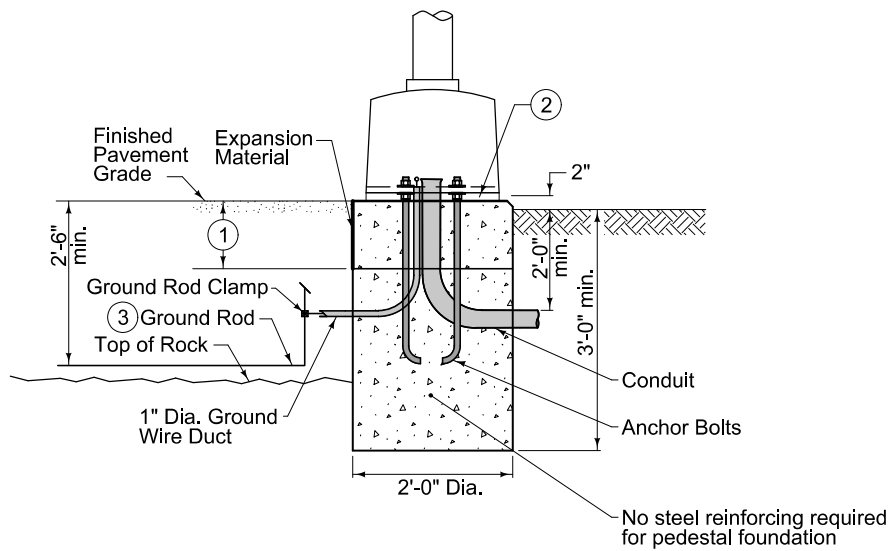

PEDESTAL POLE FOUNDATION IN SOIL OR ROCK

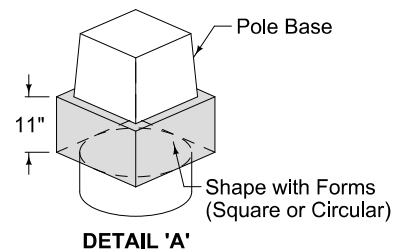

| | | |
|--|--------------------|--|
| SUDAS | IOWADOT | REVISION |
| | | 3 04-16-19 |
| FIGURE 8010.102 | STANDARD ROAD PLAN | TS-102 |
| | | SHEET 4 of 4 |
| <small>REVISIONS: Added Detail 'A' on Sheets 1, 3, and 4. Modified table on Sheet 3.</small> | | |
| Paul D. Wigand SUDAS DIRECTOR | | Stuart Miller DESIGN METHODS ENGINEER |
| TRAFFIC SIGNAL POLE FOUNDATION | | |

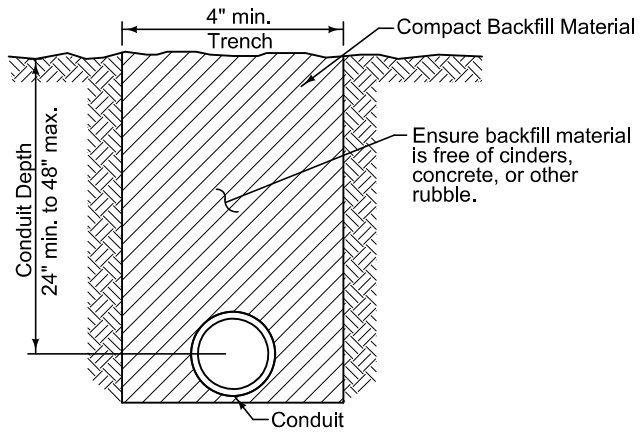

CONDUIT IN TRENCH

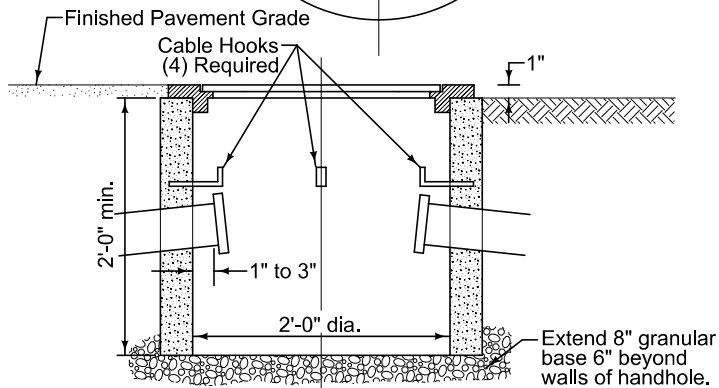
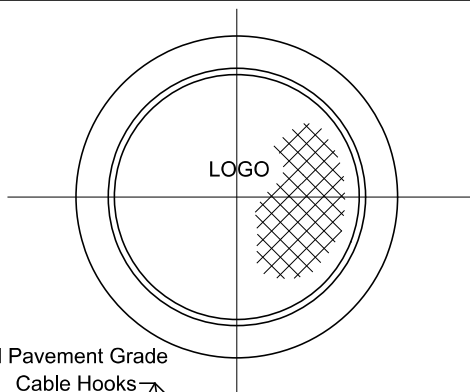

PRECAST CONCRETE HANDHOLE (TYPE I)

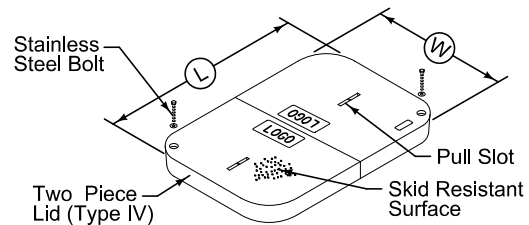
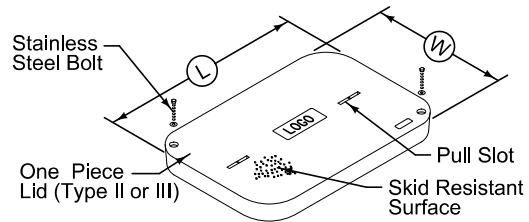

| HANDHOLE DIMENSIONS TABLE (NOMINAL) | | | |
|-------------------------------------|-----|-----|-----|
| TYPE | L | W | D |
| II | 30" | 17" | 24" |
| III | 36" | 24" | 30" |
| IV | 48" | 30" | 36" |

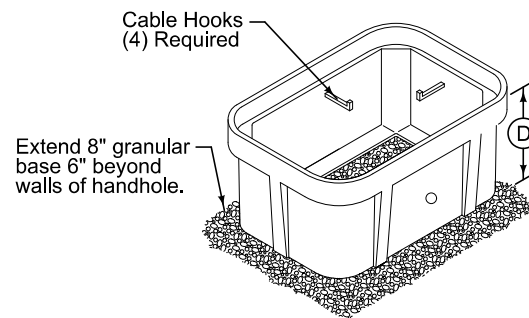

PRECAST CONCRETE COMPOSITE HANDHOLE

FIGURE 8010.103 SHEET 1 OF 1

| | | |
|---|--------------------|---|
| | | REVISION |
| | | New 10-21-14 |
| FIGURE 8010.103 | STANDARD ROAD PLAN | LI-103 |
| REVISIONS: New. | | SHEET 1 of 1 |
| <i>Paul D. Wigand</i> SUDAS DIRECTOR | | <i>Brian Smith</i> DESIGN METHODS ENGINEER |
| CONDUIT AND PRECAST HANDHOLES | | |

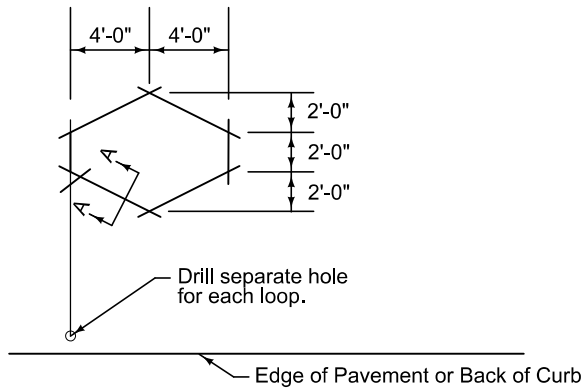

MODIFIED DIAMOND DETECTOR LOOP

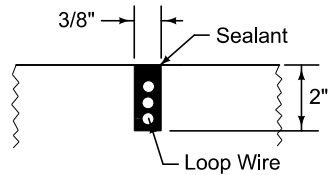

SECTION A-A

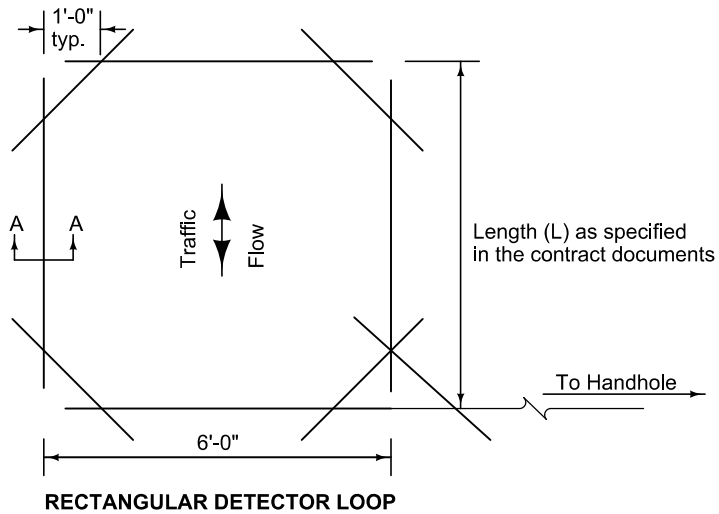

RECTANGULAR DETECTOR LOOP

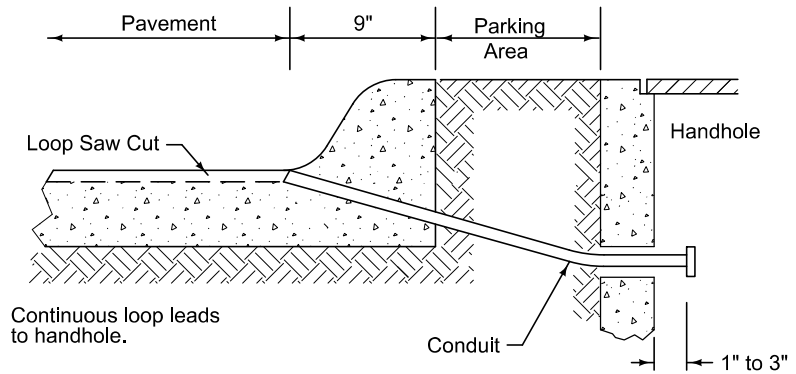

CURB

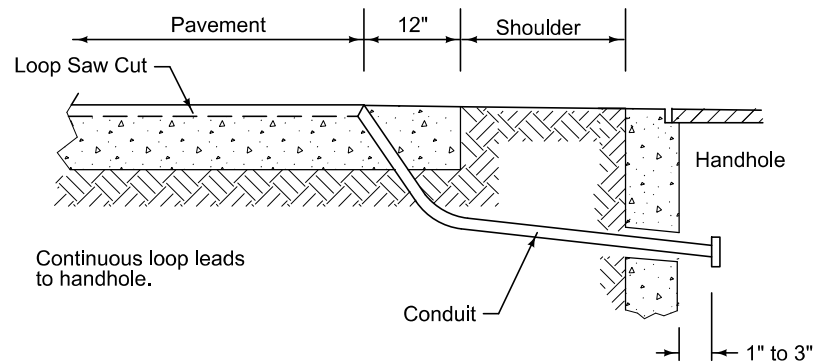

NO CURB

DETECTOR CONDUIT ENTRY

FIGURE 8010.104 SHEET 1 OF 1

| | |
|-------------------------------------|--------------------------|
| | REVISION New 10-16-12 |
| | 8010.104 |
| | SHEET 1 of 1 |
| SUDAS Standard Specifications | |
| INDUCTIVE LOOP VEHICLE DETECTORS | |

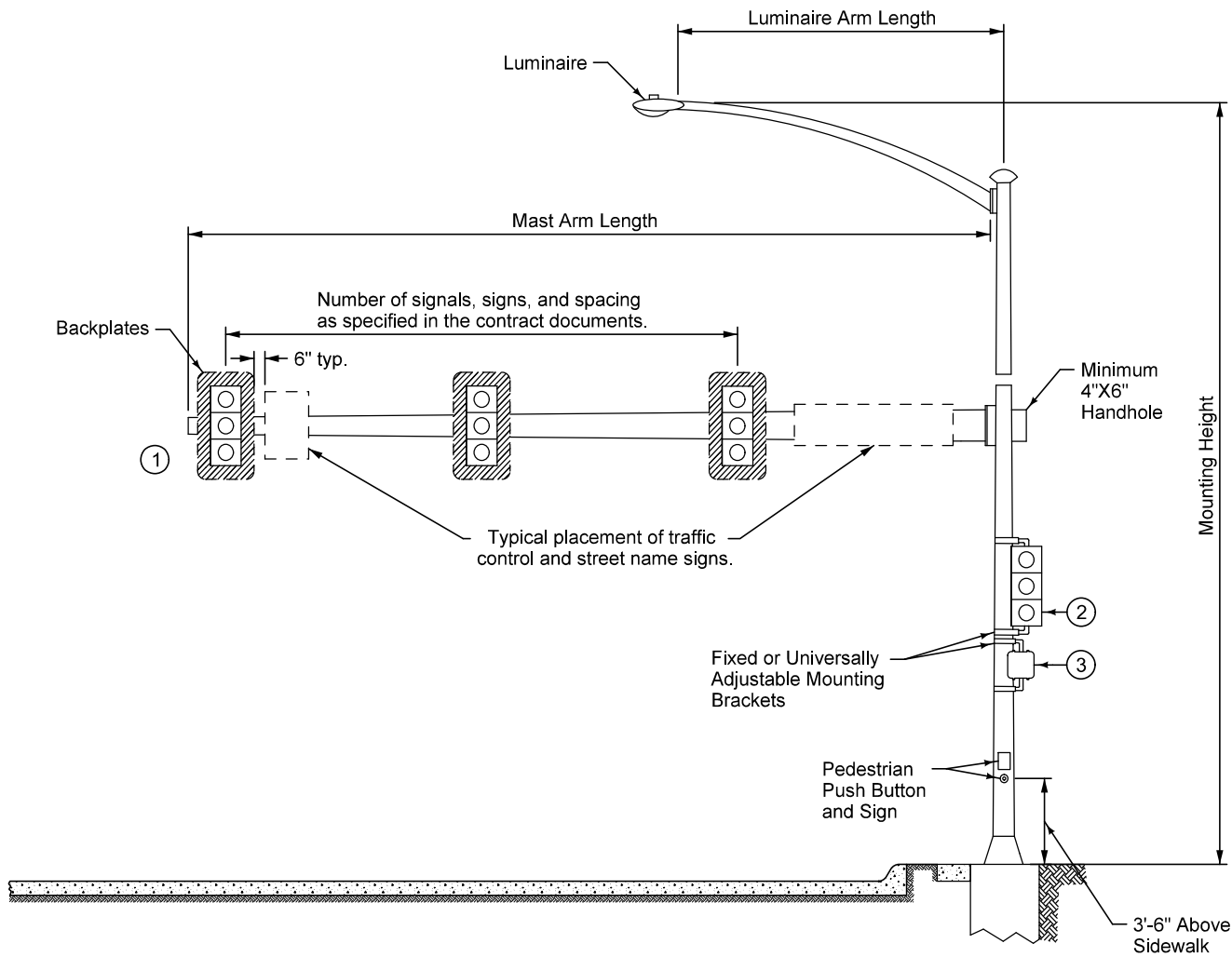

STEEL MAST ARM POLE

- ① Ensure the top of the signal housing is no more than 25.6 feet above the pavement. Ensure the bottom of the signal housing and related attachments are at least 15 feet above the pavement.
- ② Ensure the bottom of the signal housing (including brackets) that is not located over a roadway is a minimum of 8 feet and a maximum of 19 feet above the sidewalk or, if there is no sidewalk, above the pavement grade at the center of the roadway.
- ③ Mount pedestrian signal heads with the bottom of the signal housing (including brackets) no less than 7 feet or more than 10 feet above the sidewalk level. Position and adjust heads to provide maximum visibility at the beginning of the controlled crosswalk.

| | |
|---|-----------------|
|  | REVISION |
| | 1 10-15-13 |
| | 8010.105 |
| SHEET 1 of 1 | |

SUDAS Standard Specifications

MAST ARM
POLE DETAILS

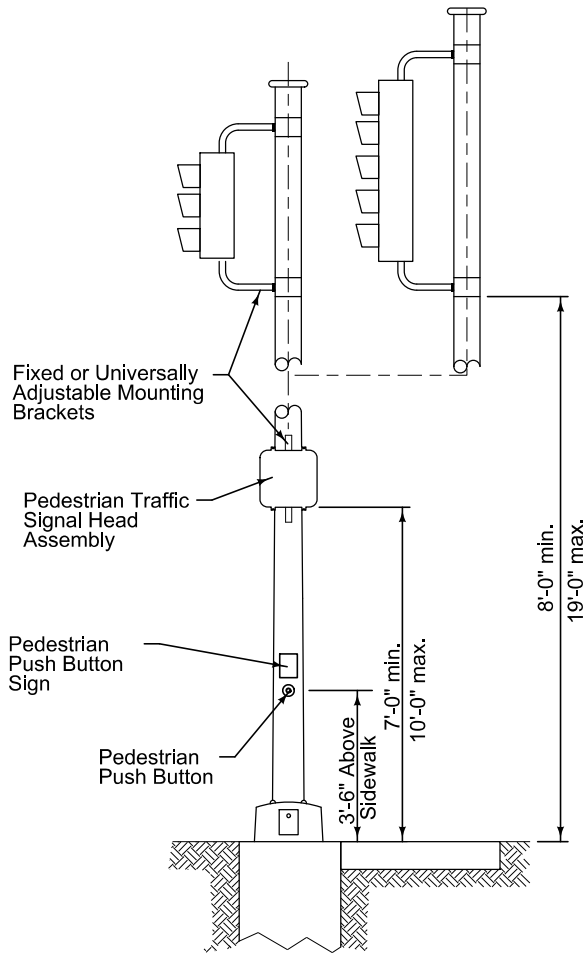

PEDESTAL POLE

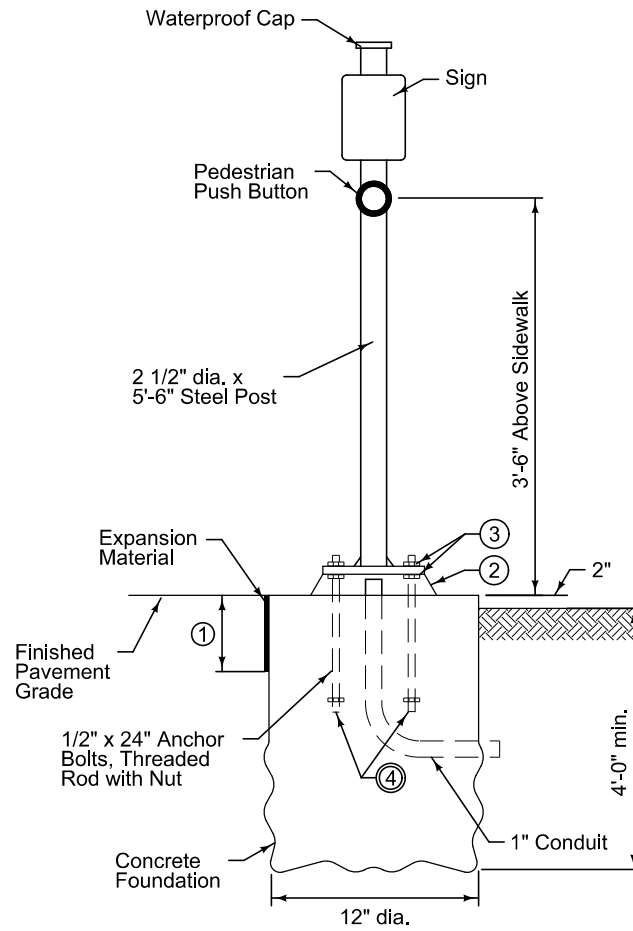

PEDESTRIAN PUSH BUTTON POST AND FOUNDATION

- ① Shape top 11 inches with forms.
- ② Install rodent guard or non-shrink grout with weep hole.
- ③ Provide 1/2 inch diameter hex nut with 1 1/2 inch flat washer. Protect anchor bolt with nut cover.
- ④ Deform threads to prevent nut from backing off.



BASE PLATE DETAIL

| | | |
|---|-----------------|----------|
|  | REVISION | |
| | 2 | 10-18-16 |
| | 8010.106 | |
| SHEET 1 of 1 | | |

SUDAS Standard Specifications

PEDESTAL POLE AND PEDESTRIAN POST DETAILS

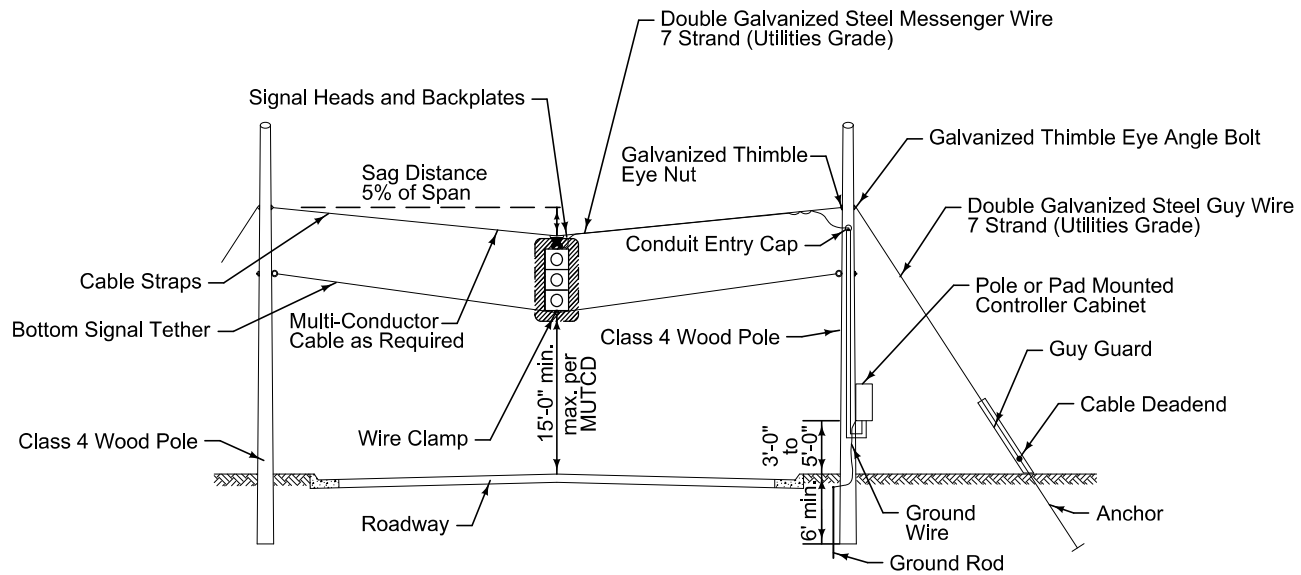



FIGURE 8010.107 SHEET 1 OF 1

| | |
|---|--------------------------|
|  | REVISION New 10-16-12 |
| | 8010.107 |
| | SHEET 1 of 1 |
| SUDAS Standard Specifications | |
| WOOD POST SPAN ASSEMBLY | |

PAVEMENT MARKINGS**PART 1 - GENERAL****1.01 SECTION INCLUDES**

- A. Permanent Pavement Markings, Symbols, and Legends
- B. Removable Pavement Markings, Symbols, and Legends
- C. Temporary Delineators
- D. Raised Pavement Markers
- E. Removal of Pavement Markings, Symbols, and Legends
- F. Grooves Cut for Pavement Markings, Symbols, and Legends

1.02 DESCRIPTION OF WORK

- A. Furnish, install, maintain, and remove permanent or temporary pavement markings, temporary delineators, and raised pavement markers, such as for:
 - 1. Diversions and on-site detours where the need for this work is anticipated as part of the traffic control plan to accommodate traffic during construction.
 - 2. Replacing markings obliterated during construction activities on roads open to public traffic.
 - 3. Changing markings on roads open to public traffic where the necessary changes result from staged construction.
 - 4. Replacing markings that are obsolete.
 - 5. Marking newly completed pavement surfaces.
 - 6. Replacing existing markings that have faded or worn away on roads open to public traffic.
- B. Permanent pavement markings are intended to remain in place after the project is completed. Temporary markings are designated for removal, will be obliterated during construction, or require changes during construction.
- C. Diversions are installations or modifications for the transfer of traffic on four lane or wider roadways to lanes that would normally carry traffic in the opposite direction. Diversions provide for continuous but restricted traffic flow from both directions for divided highways. Diversions usually include crossovers.
- D. On site detours are temporary roadways specifically constructed to accommodate traffic during construction.

1.03 SUBMITTALS

Comply with Division 1 - General Provisions and Covenants as well as the following:

- A. Submit a list of pavement marking materials proposed for use on the project.
- B. Provide the Engineer with a copy of the manufacturer's recommendations for applying the pavement marking.

1.04 SUBSTITUTIONS

Comply with Division 1 - General Provisions and Covenants.

1.05 DELIVERY, STORAGE, AND HANDLING

Comply with Division 1 - General Provisions and Covenants.

1.06 SCHEDULING AND CONFLICTS

Comply with Division 1 - General Provisions and Covenants.

1.07 SPECIAL REQUIREMENTS

None.

1.08 MEASUREMENT AND PAYMENT**A. General:**

1. Painted, taped, or removed lines will be measured in stations based upon a single 4 inch width.
2. The length of each type of marking will be as specified in the contract documents and will consider measured field adjustments.
3. The measurement for dashed and dotted lines will be adjusted to exclude the skips.
4. Measured lengths of lines wider than 4 inches will be multiplied by a width factor as follows:

$$\text{Width Factor} = \text{Actual Width} / 4 \text{ inches}$$

B. Painted Pavement Markings, Solvent/Waterborne:

1. **Measurement:** Each type of painted pavement marking will be measured in stations.
2. **Payment:** Payment will be made at the unit price for each type of painted pavement marking.
3. **Includes:** Unit price includes, but is not limited to, reflectorizing spheres, layout, surface preparation, and application of marking paint.

C. Painted Pavement Markings, Durable:

1. **Measurement:** Each type of painted pavement markings will be measured in stations.
2. **Payment:** Payment will be made at the unit price for each type of painted pavement marking.
3. **Includes:** Unit price includes, but is not limited to, layout, surface preparation, and application of marking paint.

1.08 MEASUREMENT AND PAYMENT (Continued)**D. Painted Pavement Markings, High-Build:**

1. **Measurement:** Each type of painted pavement markings will be measured in stations.
2. **Payment:** Payment will be made at the unit price for each type of painted pavement marking.
3. **Includes:** Unit price includes, but is not limited to, layout, surface preparation, and application of marking paint.

E. Permanent Tape Markings:

1. **Measurement:** Each type of marking tape will be measured in stations.
2. **Payment:** Payment will be made at the unit price for each type of tape marking.
3. **Includes:** Unit price includes, but is not limited to, layout, surface preparation, and application of marking tape.

F. Wet, Retroreflective Removable Tape Markings:

1. **Measurement:** Wet, retroreflective removable tape markings will be measured in stations.
2. **Payment:** Payment will be made at the unit price per station for wet, retroreflective removable tape markings.
3. **Includes:** Unit price includes, but is not limited to layout, surface preparation, application, and removal.

G. Painted Symbols and Legends:

1. **Measurement:** Each type of painted symbol and legend will be counted.
2. **Payment:** Payment will be made at the unit price for each painted symbol and legend.
3. **Includes:** Unit price includes, but is not limited to, layout, surface preparation, and application of each symbol and legend.

H. Precut Symbols and Legends:

1. **Measurement:** Each type of precut symbol and legend will be counted.
2. **Payment:** Payment will be made at the unit price for each precut symbol and legend.
3. **Includes:** Unit price includes, but is not limited to, layout, surface preparation, and application of each symbol and legend.

I. Temporary Delineators:

1. **Measurement:** Each temporary delineator installed and removed will be counted.
2. **Payment:** Payment will be made at the unit price for each delineator.
3. **Includes:** Unit price includes, but is not limited to, installation and removal of delineators.

1.08 MEASUREMENT AND PAYMENT (Continued)**J. Raised Pavement Markers:**

1. **Measurement:** Each raised pavement marker installed and removed will be counted.
2. **Payment:** Payment will be made at the unit price for each marker.
3. **Includes:** Unit price includes, but is not limited to, installation and removal of pavement markers.

K. Pavement Markings Removed:

1. **Measurement:** Pavement markings removed will be measured in stations. Removable marking tape or markings obliterated during construction will not be measured.
2. **Payment:** Payment will be made at the unit price for pavement markings removed.
3. **Includes:** Unit price includes, but is not limited to, pavement marking removal and waste material collection, removal, and disposal.

L. Symbols and Legends Removed:

1. **Measurement:** Each symbols or legends removed will be counted.
2. **Payment:** Payment will be made at the unit price for each symbol or legend removed.
3. **Includes:** Unit price includes, but is not limited to, symbol and legend marking removal and waste material collection, removal, and disposal.

M. Grooves Cut for Pavement Markings:

1. **Measurement:** Measurement will be in stations and will be equivalent to the quantity of pavement markings associated with the grooving.
2. **Payment:** Payment will be made at the unit price per station.
3. **Includes:** Unit price includes, but is not limited to, layout, cutting grooves, collection and disposal of removed material, and additional groove width and transition length beyond the pavement marking dimensions.

N. Grooves Cut for Symbols and Legends:

1. **Measurement:** Each symbol or legend groove will be counted.
2. **Payment:** Payment will be made at the unit price for each symbol or legend groove.
3. **Includes:** Unit price includes, but is not limited to, layout, cutting grooves, and collection and disposal of removed material.

PART 2 - PRODUCTS**2.01 MATERIALS**

- A. Provide pavement marking materials that comply with Iowa DOT Section 2527.
- B. Pavement marking materials include:
 - 1. Wet, retroreflective removable tape markings
 - 2. Painted Pavement Markings:
 - a. Waterborne and solvent based paint pavement markings
 - b. Durable paint pavement markings
 - c. High-build waterborne paint pavement markings
 - 3. Regular marking tape
 - 4. Temporary delineators
 - 5. Raised pavement markers
 - 6. Channelizer markers
 - 7. Preformed polymer tape
 - 8. Removable, nonreflective preformed tape
 - 9. Profiled pavement marking tape
 - 10. Intersection marking tape

PART 3 - EXECUTION**3.01 EQUIPMENT**

A. General: Utilize equipment complying with Iowa DOT Section 2527.

B. Pavement Marking Equipment:

1. Capable of placing two lines simultaneously with either line in a solid or intermittent pattern in yellow or white.
2. Capable of applying reflectorizing spheres at the required rate with a pressurized system.
3. All guns in full view of the operator at all times.
4. Equipped with a metering device to register the accumulated length of each gun, each day.
5. Designed so the pressure gages of each proportioning pump are visible to the operator at all times during operation to monitor fluctuations in pressure.
6. Capable of applying paint without dilution.

C. Pavement Marking Removal:

1. Operates without the release of dust.
2. Recovers all removed material.
3. Includes a waste collection and transfer system and for dry wastes, ensure the system incorporates high-efficiency particulate absorption (HEPA) methods and equipment.

D. Pavement Grooving:

1. Utilize grooving equipment with stacked diamond cutting heads mounted on a floating head with controls capable of providing uniform depth and alignment.
2. If pavement is grooved by dry cutting, provide equipment that is self vacuuming.
3. When requested, make available to the Engineer a caliper, depth gage, or depth plate, for use in measuring groove depth.

3.02 CONSTRUCTION

A. General:

1. Comply with the requirements of the MUTCD for traffic control during all pavement marking operations.
2. Install all pavement markings according to the product manufacturer's published recommendations.

3.02 CONSTRUCTION (Continued)

3. Ensure the following for all painted and taped pavement markings:
 - a. Uniform thickness
 - b. Uniform distribution of reflectorizing spheres throughout the line width
 - c. Line widths as specified, with a tolerance of $\pm 1/4$ inch for 4 inch lines and $\pm 1/2$ inch for wider lines
 - d. Symbols and Legends are visually proportional to contract documents with an out-to-out tolerance of ± 6 inches
 - e. Markings have sharp edges and cutoffs at the ends
 4. For all painted markings:
 - a. Apply the paint without dilution
 - b. Apply reflectorizing spheres immediately to the wet-paint with a pressurized system
 5. For all tape products, follow the manufacturer's recommendations for surface dryness, primers, adhesives, and other surface preparation requirements. Unless otherwise specified by the tape manufacturer, meet the following test for determining surface dryness before applying the tape:
 - a. In an area of direct sunlight where the tape will be applied, place an 18 inch by 18 inch piece of polyethylene (a green or black garbage bag may be used). There should not be any holes or tears in the polyethylene.
 - b. Tape down all the edges of the polyethylene sheet to seal all the edges and not allow any air movement to get under the polyethylene.
 - c. Firmly tamp the tape using the tamper cart or by foot tamping.
 - d. Allow 20 to 25 minutes for the polyethylene to be exposed to the direct sunlight.
 - e. Remove the polyethylene from the road surface. If no moisture is present on the underside of the polyethylene or on the road surface, the tape can be applied.
 - f. If any moisture is present, allow another hour to pass and repeat the test until no moisture is found.
- B. Surface Preparation:** For all pavement markings, ensure the pavement surface is dry and free from dirt, dust, oil, curing compound, and other contaminants that may interfere with markings properly bonding to the surface.
1. Clean surface to at least 1 inch wider than the anticipated marking.
 2. Unless otherwise specified, sweep the pavement surface with a rotary broom or street sweeper.
 3. Shoot an air blast on the pavement surface immediately prior to placing the new marking. The air blast is not intended to remove large amounts of dust, but only the residue that might be left from the removal and cleaning operation.
 4. When pavement markings are placed on newly constructed PCC pavements, remove the existing curing compound film from horizontal surfaces in these locations. Curing compound film need not be removed from curbs or other vertical surfaces. Remove the curing compound in a manner that does not damage the underlying pavement.

3.02 CONSTRUCTION (Continued)**C. Painted Pavement Markings:**

1. **Waterborne and Solvent Based Paint:** Apply paint and reflectorizing spheres at the nominal rates shown in the following tables.

Table 8020.01: Waterborne Paint Application Rates

| Line Width | Wet-Film Thickness | Paint | Reflectorizing Spheres |
|------------|--------------------|--|------------------------|
| 4" | 14 mils | 343 ft of solid line per gallon of paint | 9.0 lb/gal |

Table 8020.02: Solvent-based Paint Application Rates

| Line Width | Wet-Film Thickness | Paint | Reflectorizing Spheres |
|------------|--------------------|--|------------------------|
| 4" | 16 mils | 300 ft of solid line per gallon of paint | 9.0 lb/gal |

2. **Durable Paint Pavement Markings:**
 - a. Use the same binder thickness as applied on the National Transportation Product Evaluation Program (NTPEP) deck with a tolerance of 10%.
 - b. Bead application rate is at the discretion of the Contractor.
 - c. Construct durable pavement markings to comply with the following retroreflectivity requirements when tested according to Iowa DOT Materials I.M. 483.04.

Table 8020.03: Minimum Coefficient of Retroreflected Luminance

| | |
|----------------------------------|----------------------------------|
| White line, symbols, and legends | 300 mcd/ft ² /ft-cdl. |
| Yellow line | 200 mcd/ft ² /ft-cdl. |

3. **High-Build Waterborne Paint Pavement Markings:**
 - a. Provide binder thickness of 0.022 inches \pm 0.0025 inches.
 - b. Bead application rate is at the discretion of the Contractor.
 - c. Construct high-build waterborne paint pavement markings to comply with the following retroreflectivity requirements when tested according to Iowa DOT Materials I.M. 483.04.

Table 8020.04: Minimum Coefficient of Retroreflected Luminance

| | |
|----------------------------------|----------------------------------|
| White line, symbols, and legends | 300 mcd/ft ² /ft-cdl. |
| Yellow line | 225 mcd/ft ² /ft-cdl. |

- D. **Marking Tape:** If grooving is specified, do not inlay the tape into hot HMA.

1. **Inlaid:** When the installation of preformed polymer pavement marking material or profiled pavement marking tape is in conjunction with placement of HMA, inlay the tape by positioning it on the HMA prior to the final rolling. Perform the installation of the tape according to the manufacturer's recommendations.
2. **Grooved:** When grooving is specified, install marking tape in recessed groove according to the manufacturer's recommendations.

- E. **Temporary Delineators:** Mount temporary delineators 4 feet above the pavement on delineator posts. Install posts 2 feet from the outside edge of the shoulder at locations specified in the contract documents.

3.02 CONSTRUCTION (Continued)

F. Raised Pavement Markers: Ensure markers continually exposed to traffic do not extend more than 3/4 inch above the pavement surface.

G. Pavement Marking Layout and Location:

- 1. Permanent Markings:** Place all lines within 2 inches of reference location. The location of edge lines may be referenced to the pavement edge. The locations of other longitudinal lines may be referenced to accurately locate longitudinal joints. Where reference locations do not exist or are not reliable, locate the lines as follows:
 - a. For straight or nearly straight lines, reference the locations to a string line set between marking line points.
 - b. For curves, reference the locations to closely spaced marking line points. For sharp curves, a spacing of 10 feet may be required.
 - c. Other equally effective systems the Engineer approves.
- 2. Temporary Markings:** The location of temporary pavement marking will be specified in the contract documents or as directed by the Engineer to maximize the effectiveness of the traffic control plan.

H. Removal of Pavement Markings:

- 1. Staging:**
 - a. At the start of construction and at each change in staging, remove all existing pavement markings that conflict with the pavement marking plan.
 - b. Prior to final pavement marking, remove all temporary pavement markings.
 - c. The Engineer may designate other pavement markings for removal to maximize the effectiveness of the traffic control plan.
- 2. Process:**
 - a. Remove existing painted pavement markings so that 90% or more of the pavement is visible. Tightly adhering markings may remain in the bottom of the tining and other depressions on the pavement surface, but ensure they are not visible to the motorist during daytime or nighttime. Remove tape markings according to the manufacturer's recommendations. Ensure removal processes do not cause functional damage to the transverse or longitudinal joint sealant materials.
 - b. Conduct pavement marking removal operations in a manner so that the finished pavement surface is not damaged or left in a pattern that may mislead or misdirect the motorist. When the operations are completed, power broom the pavement surface. Remove all marking removal debris from the pavement surface before the pavement is open to public traffic.
 - c. Perform pavement marking removal to a width no less than the width of the existing or new pavement markings plus 1 inch. Remove the entire area of the existing symbol or legend in a rectangular shape so no directionality may be observed from the removed symbol or legend.
 - d. Removal of pavement markings may be performed by vacuum blasting, vacuum dry grinding, wet grinding, shot blasting, or high pressure water blasting. Open abrasive blasting or dry grinding without containment is not allowed.

I. Markings Obliterated During Construction:

1. On sections of pavement open to traffic, place pavement markings where construction or traffic operations have obliterated existing markings.

3.02 CONSTRUCTION (Continued)

2. Replace markings obliterated during construction within 3 calendar days after the operation that obliterated the markings has been completed. At intersections with Iowa DOT highways, replace all obliterated edge lines, lane lines, no passing zones, and centerlines prior to opening to traffic.
 3. Place symbols and legends within 3 calendar days from the day the road is open to traffic.
- J. Grooving for Pavement Markings:** When specified in the contract documents, place pavement markings in a groove cut into the pavement surface. Dry or wet cut the groove in a single pass.
1. **Groove Depth:** Construct groove according to pavement marking material manufacturer's recommendations with the following minimums.
 - a. **Paint:** Minimum groove depth of 60 mils.
 - b. **Tape:** Minimum groove depth of 100 mils.
 2. **Groove Width:** Marking width plus 1 inch with a tolerance of minus 0.0 inches and plus 0.2 inches.
 3. **Groove Length:** Full length of tape plus 3 inches minimum grooving transition on either end. Do not use a continuous groove for dash markings. When replacing existing dash markings, start cycle so most of the existing marking is removed with the groove. No additional removal of existing markings is required.
 4. **Groove Position:** Locate grooves a minimum of 2 inches from edge of longitudinal joints.
 5. **Finished Surface:** Ensure the bottom of the groove has a fine corduroy-like texture. The maximum allowable rise between the high and low points across the width of the groove is 10 mils.
 6. **Groove Cleaning:** Ensure the surface to receive the marking is free from dust, dirt, or other contaminants that may interfere with the marking properly bonding.
 - a. **Dry Cutting:** Vacuum and broom grooves using a high pressure air blast for the final cleaning.
 - b. **Wet Cutting:**
 - 1) Immediately flush the groove with high pressure water and recover the removed material.
 - 2) Allow the surface to dry a minimum of 24 hours to a visibly dry condition.
- K. Limitations:**
1. **General:**
 - a. Coordinate pavement marking application with other construction work and associated traffic control changes.
 - b. Complete the placement of pavement markings before the lane, road, on-site detour, or diversion is open to traffic.
 - c. If unavoidable circumstances result in not being able to complete the pavement marking placement or removal specified for that day, provide traffic control until the pavement marking placement or removal work is completed.
 - d. Follow the manufacturer's written recommendations for all details of application.

3.02 CONSTRUCTION (Continued)**2. Temperature Restrictions:**

- a. Waterborne and Solvent Based Paint Pavement Markings:** Comply with Table 8020.05.

Table 8020.05: Pavement Marking Temperature Restrictions

| Type of Marking | Oct. 23 to April 7 | April 8 to April 22 | April 23 to Oct. 7 | Oct. 8 to Oct. 22 |
|---|--------------------|---------------------|--------------------|-------------------|
| Waterborne Paint | not allowed | 45° F | 45° F | 45° F |
| Low Temperature Waterborne Paint with Rohm & Haas XSR Resin | 35° F | 35° F | 35° F | 35° F |
| Solvent Based Paint | No restrictions | No restrictions | (a) | No restrictions |

(a) Only use solvent-based paint if temperature requirements for waterborne paint cannot be met.

b. Durable Paint Pavement Markings:

- 1) Air and pavement surface temperature are 40°F and rising.
- 2) The Engineer may allow placement of durable paint at temperatures below these values based on the durable paint manufacturer's written recommendations.

c. High-Build Waterborne Paint Pavement Markings:

- 1) Air and pavement surface temperature are 50°F and rising.
- 2) When temperatures are below 50°F, the Engineer may approve the use of marking products denoted by the manufacturer as "low-temperature." When approved, low-temperature paints may be applied when temperatures are between 32°F and 50°F.

d. Marking Tape Pavement Markings:

- 1) Air and pavement surface temperature are 50°F and rising.
- 2) Minimum overnight temperature of 40°F the night before application
- 3) The Engineer may allow placement of marking tape at temperatures below these values based on the marking manufacturer's written recommendations.

END OF SECTION

TEMPORARY TRAFFIC CONTROL**PART 1 - GENERAL****1.01 SECTION INCLUDES**

- A. Temporary Traffic Control Devices
- B. Installation
- C. Maintenance
- D. Quality Control

1.02 DESCRIPTION OF WORK

This part of the specifications includes materials, equipment, and procedures for traffic control during construction. Furnish, erect, operate, maintain, move, and remove all traffic control devices required. Comply with the current edition of the MUTCD as adopted by the Iowa DOT.

1.03 SUBMITTALS

Comply with Division 1 - General Provisions and Covenants, as well as the following:

- A. Submit a traffic control plan for review and approval prior to installation.
- B. Submit proposed modifications to the traffic control plan for review and approval prior to making changes.

1.04 SUBSTITUTIONS

Comply with Division 1 - General Provisions and Covenants.

1.05 DELIVERY, STORAGE, HANDLING, AND SALVAGING

Comply with Division 1 - General Provisions and Covenants.

1.06 SCHEDULING AND CONFLICTS

Comply with Division 1 - General Provisions and Covenants.

1.07 SPECIAL REQUIREMENTS

- A. When a bid item for Temporary Traffic Control is included on the proposal form, comply with this section for measurement and payment
- B. When the proposal form does not include a bid item for temporary traffic control, all costs incurred by the contractor for temporary traffic control are incidental to other work and will not be paid for separately.
- C. Provide 10 calendar days advance notification of a pedestrian path closure to the Engineer and the National Federation of the Blind of Iowa (www.nfbi.org).

1.08 MEASUREMENT AND PAYMENT**A. Temporary Traffic Control:**

1. **Measurement:** Lump sum item; no measurement will be made.
2. **Payment:** Payment will be at the lump sum price for temporary traffic control. Proportional payments will be made equal to the percentage of the dollar amount paid on the original contract amount.
3. **Includes:** Lump sum price includes, but is not limited to, installation, maintenance, and removal of temporary traffic control; total roadway closures with installation and removal of detour signing as shown in the contract documents; removal and reinstallation or covering of permanent traffic control devices that conflict with the temporary traffic control plan; monitoring and documenting traffic control conditions; and flaggers. When required in the contract documents, the following are also included in traffic control unless a separate bid item is provided: portable dynamic message signs, temporary barrier rail, temporary flood lighting, and pilot cars.

PART 2 - PRODUCTS**2.01 GENERAL**

Use products and materials complying with Part 6 of the MUTCD.

2.02 SIGNS

A. Material: Sheet aluminum, galvanized steel, plywood, or flexible roll-up material complying with Iowa DOT Article 4186.02.

B. Size and Type:

1. **Regulatory Signs:** As indicated in the contract documents or recommended in the MUTCD.
2. **Sidewalk Signs:** Minimum size 12 inch by 24 inch.
3. **Warning Signs:** Comply with Table 8030.01.

Table 8030.01: Warning Signs

| Speed Limit (mph) | Minimum Sign Size | Minimum Uppercase Letter Size | Minimum Plaque Size |
|-------------------|-------------------|-------------------------------|---------------------|
| < 25 | 30" x 30" | 4" | 18" x 18" |
| 25 - 35 | 36" x 36" | 5" | 18" x 24" |
| >35 | 48" x 48" | 7" | 24" x 30" |

C. Retroreflective Sheeting: Comply with Iowa DOT Article 4186.03.

D. Posts:

1. **Wood Posts:** Comply with Iowa DOT Section 4164.
2. **U-Shaped Rail Steel Posts:** 3.0 pounds per foot.
3. **Perforated Square Steel Tube Posts:** 2 1/4 or 2 1/2 inch square 12 gage perforated steel tubing.

E. Portable Sign Stands: Crashworthy per the test and evaluation criteria of NCHRP Report 350 or Manual on Assessing Safety Hardware (MASH). Must be stable in windy conditions.

2.03 CHANNELIZING DEVICES

Channelizing devices include cones, channelizers, tubular markers, vertical panels, drums, and barricades.

A. Retroreflective Sheeting: Comply with Iowa DOT Article 4186.03.

B. Cones: Minimum height of 18 inches for daytime and speed less than or equal to 35 mph. Minimum height of 28 inches with retroreflective bands for nighttime or speed greater than 35 mph.

C. Channelizers: 42 inch height with retroreflective bands and 16 pound base.

D. Tubular Markers: Minimum diameter 2 inches with retroreflective bands. Minimum height 18 inches for daytime and speed less than or equal to 35 mph. Minimum height 28 inches for nighttime or speed greater than 35 mph.

2.03 CHANNELIZING DEVICES (Continued)

- E. Vertical Panels:** Minimum height 36 inches with 8 to 12 inch panel width and 24 inch minimum panel height.
- F. Drums:** Minimum width 18 inches. Minimum height 36 inches.
- G. Barricades:** Minimum rail length 2 feet for Type I or Type II barricades. Minimum rail length 4 feet for Type III barricades. Minimum height of top rail for Type I and Type II equals 3 feet and minimum height to top rail of a Type III is 5 feet.

2.04 MISCELLANEOUS PRODUCTS

- A. Orange Mesh Safety Fence:** Comply with Iowa DOT Article 4188.03.
- B. Temporary Barrier Rail:** Unless otherwise specified, use precast concrete units. Comply with Iowa DOT Standard Road Plan BA-401.

2.05 EQUIPMENT

- A. Warning Lights:**
 - 1. For nighttime installation, provide Type A warning lights visible to both directions of traffic.
 - 2. For 24 hour installations, provide Type B warning lights.
- B. Arrow Boards:** When required, provide Type A, B, or C arrow boards operating in sequential chevron mode.
- C. Portable Dynamic Message Signs:** Comply with Iowa DOT Article 4188.07.
- D. Pilot Cars:** Pickup trucks or automobiles with G20-4 signs reading: PILOT CAR - FOLLOW ME. Mount two signs on each vehicle, visible from both directions of traffic. Mount signs with bottom of signs at least 1 foot above the top of the vehicle's roof.
- E. Vehicle Warning Lights:** Supply amber, high-intensity rotating, flashing, oscillating, or strobe light.

2.06 FLAGGERS

- A. General:** Comply with the current Iowa DOT Flagger's Handbook for flagger operations, equipment, and apparel.
- B. Lighting:** Provide auxiliary lighting at flagger stations when nighttime flagging is required.
- C. Training:** For other than short time, emergency, or relief assignment of flaggers, provide flagger training to include the following:
 - 1. Issuing a copy of the current Iowa DOT Flagger's Handbook to and review by each flagger.
 - 2. Presentation of the current Iowa Professional Flagging Video to each flagger.
 - 3. Issuing a flagger training card to each flagger, to be carried at all times and shown upon request. Include the following information on training card:
 - a. Employee name
 - b. Date of training
 - c. Name of instructor
 - d. Expiration date of December 31 of the year following the training date

PART 3 - EXECUTION**3.01 INSTALLATION**

- A. General:** Install temporary traffic control devices according to the Section 8030 figures and Part 6 of the MUTCD.
- B. Sign Posts:** For durations more than 3 consecutive calendar days, mount the signs on fixed posts. For durations 3 consecutive calendar days or less, mount the signs on fixed posts or movable skids.
- C. Temporary Barrier Rail:** Place at locations specified in the contract documents. Tie and anchor units as shown on Iowa DOT Standard Road Plan BA-401.
- D. Sandbags:** Use sandbags to anchor all traffic control devices subject to movement by wind. Do not place sandbags on tops of barricades, drums, or vertical panels.
- E. Conflicting Signs:** Cover or remove signs with messages conflicting with temporary traffic control as approved or directed by the Engineer.
- F. Modifications:** Submit proposed traffic control plan modifications to the Engineer for review and approval prior to making changes.

3.02 MAINTENANCE

- A. General:** Promptly repair, replace, reposition, or clean traffic control devices, as needed, or as directed by the Engineer.
- B. Non-working Hours:** At the end of working hours, remove, cover, or turn down traffic control devices intended for working hours only.

3.03 QUALITY CONTROL

- A. Traffic Control Technician:** Maintain a traffic control technician on staff, responsible for the Contractor's traffic control quality control program, that has attended and passed the exam in one of the following classes:
 - 1. ATSSA Traffic Control Technician
 - 2. IMSA Work Zone Traffic Control
 - 3. Minnesota DOT Traffic Control Supervisor
 - 4. Texas Engineering Extension Service Work Zone Traffic Control
- B. Monitoring and Documentation:** Provide 24 hour mobile phone number for the traffic control technician. On a daily basis, perform the following quality control work associated with monitoring and documenting traffic control conditions.
 - 1. Review all traffic control operations for compliance with the contract documents.
 - 2. Monitor traffic operations and submit proposed traffic control plan changes to the Engineer for approval.
 - 3. Coordinate all changes to the traffic control plan.
 - 4. Coordinate all traffic control operations, including those of subcontractors and suppliers.

3.03 QUALITY CONTROL (Continued)

5. Maintain a traffic control diary to be submitted at the end of the project or as requested by the Engineer, with the following information:
 - a. Listing and locating traffic control used each day, referenced to appropriate plan sheet or standard.
 - b. All reviews of traffic control devices and operations, whether satisfactory or unsatisfactory, and corrections made.
 - c. Approved changes to traffic control specified in the contract documents.
 - d. Incidentals affecting the efficiency and safety of traffic.
 - e. A list of trained flaggers used.

END OF SECTION

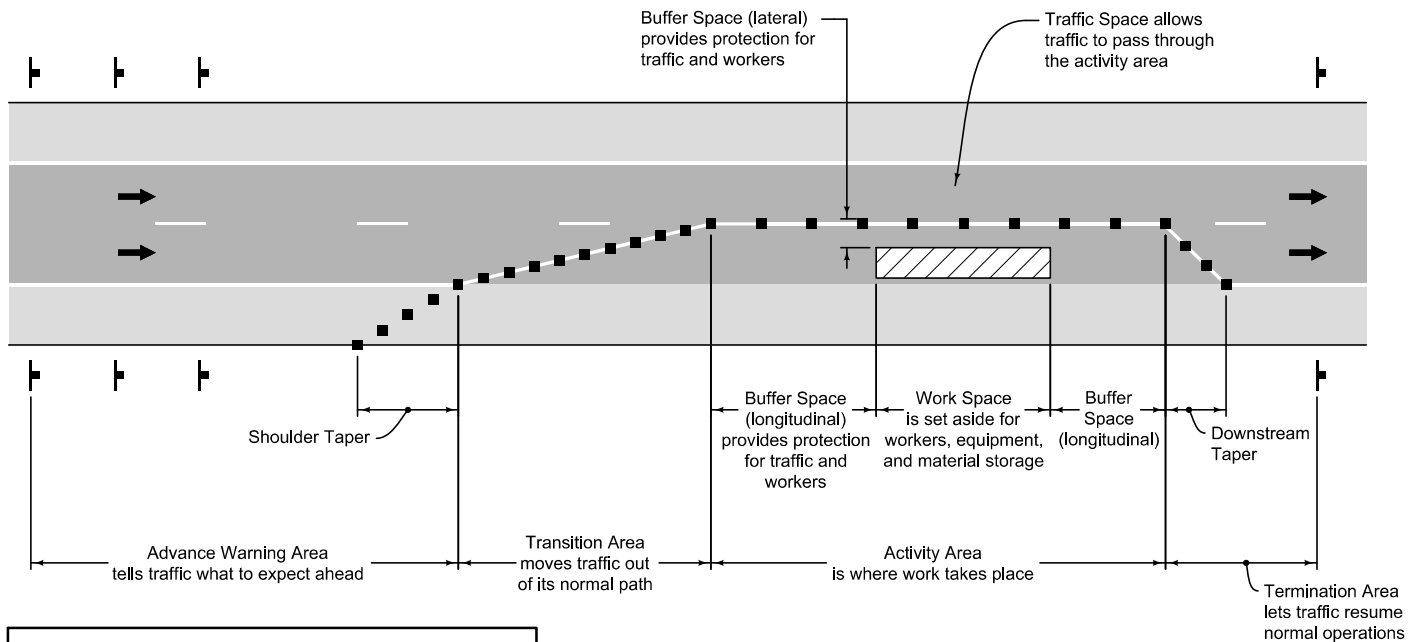

It may be necessary to combine two or more examples to adequately address the traffic control needed.

Utilize vehicle warning lights (amber, high-intensity rotating, flashing, oscillating, or strobe light) on all shadow and work vehicles.

Vehicle hazard lights may be used to supplement warning lights. Do not use hazard lights alone.

Flags may be used to call attention to the advanced warning signs.

If a closure extends overnight, utilize channelizing devices with retroreflective sheeting.

Speed limit refers to the legally established and signed speed limit.

If an arrow board is used on 2-lane roads, operate only in the caution mode.

Adjust the position of warning signs and channelizing devices for available sight distance.

Do not install temporary traffic control devices until work is ready to begin, and remove or cover all signs and devices promptly when they are not needed.

The END WORK (G20-2) signs shown on all figures are optional.

Key*

- Arrow Board
- Arrow Board Support or Trailer
- Channelizing Device
- Direction of Traffic
- Drum
- Flagger
- Pedestrian Channelizing Device
- Safety Fence
- Shadow Vehicle
- Sign (shown facing left)
- Type III Barricade
- Work Space
- Work Vehicle
- Vehicle Warning Light (amber, high-intensity rotating, flashing, oscillating, or strobe light)

*Applies to all Section 8030 figures

| Distance Between Signs | |
|------------------------|-----|
| Speed Limit (mph) | A |
| 20-25 | 100 |
| 30-40 | 250 |
| 45-50 | 350 |
| 55 | 500 |

| Channelizing Device Spacing | | | |
|-----------------------------|------------|-------------|-----------------|
| Speed Limit (mph) | Taper (ft) | Buffer (ft) | Work Space (ft) |
| 20 | 20 | 40 | 40 |
| 25 | 25 | 50 | 50 |
| 30 | 30 | 60 | 60 |
| 35 | 35 | 70 | 70 |
| 40 | 40 | 80 | 80 |
| 45 | 45 | 90 | 90 |
| 50 | 50 | 100 | 100 |
| 55 | 55 | 110 | 110 |

| Merging Taper Lengths for Lane Closure* | | |
|---|-----------------------|-------------------|
| Speed Limit (mph) | Taper Length (L) (ft) | Number of Devices |
| 20 | 80 | 5 |
| 25 | 125 | 6 |
| 30 | 180 | 7 |
| 35 | 245 | 8 |
| 40 | 320 | 9 |
| 45 | 540 | 13 |
| 50 | 600 | 13 |
| 55 | 660 | 13 |

*Values shown are for a 12 foot shift. Table does not apply to one-lane, two-way (flagger) tapers

| | |
|--------------|----------|
| REVISION | |
| New | 10-17-17 |
| 8030.101 | |
| SHEET 1 of 1 | |

SUDAS Standard Specifications

**TEMPORARY TRAFFIC CONTROL
GENERAL INFORMATION**

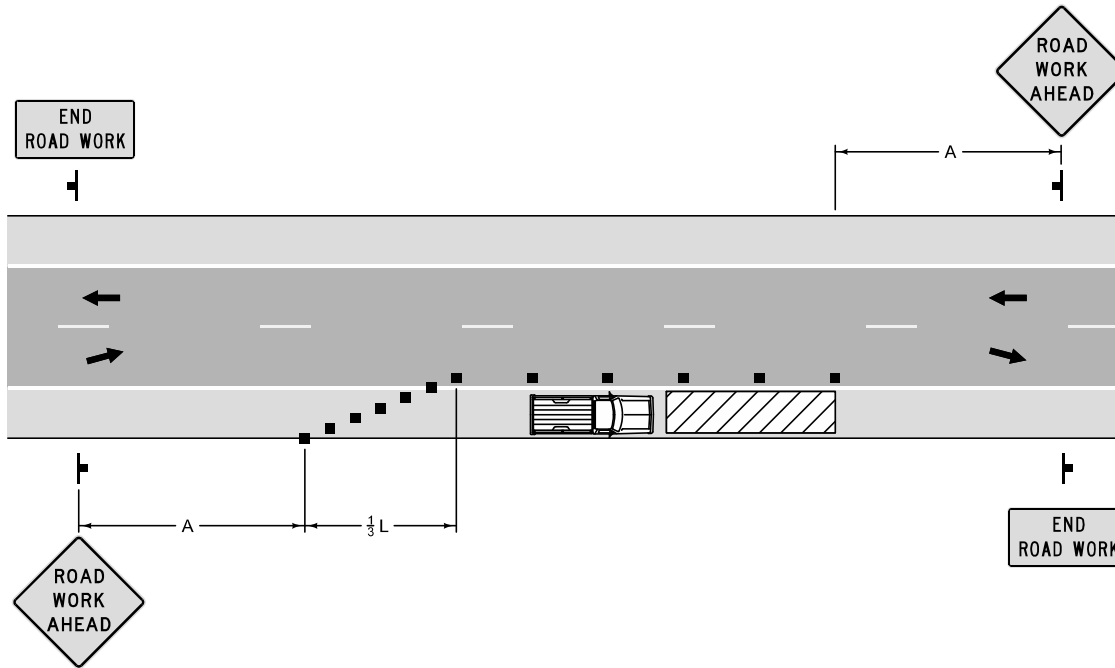

Use only on minor, low speed (≤ 40 mph) streets. Provide a lane closure for higher speed traffic conditions.

Maintain a minimum lane width of 10 feet as measured to the near face of channelizing devices. For short-term use on low speed, low volume roads without wider heavy commercial vehicles, a minimum lane width of 9 feet may be used.

Where the opposite shoulder is suitable for carrying vehicular traffic, lanes may be shifted by using closely spaced channelizing devices provided the resulting lane widths are at least 10 feet wide.

Additional advanced warning may be appropriate, such as a ROAD NARROWS sign.

For short-term work, the taper and channelizing devices may be omitted if a shadow vehicle with activated vehicle warning lights is used.

Refer to Figure 8030.101 for symbol key and sign spacing.

| | |
|---|-----------------|
|  | REVISION |
| | New 10-17-17 |
| | 8030.102 |
| SHEET 1 of 1 | |
| SUDAS Standard Specifications | |
| WORK OFF OF PAVEMENT WITH MINOR ENCROACHMENT ONTO TRAVELED WAY | |

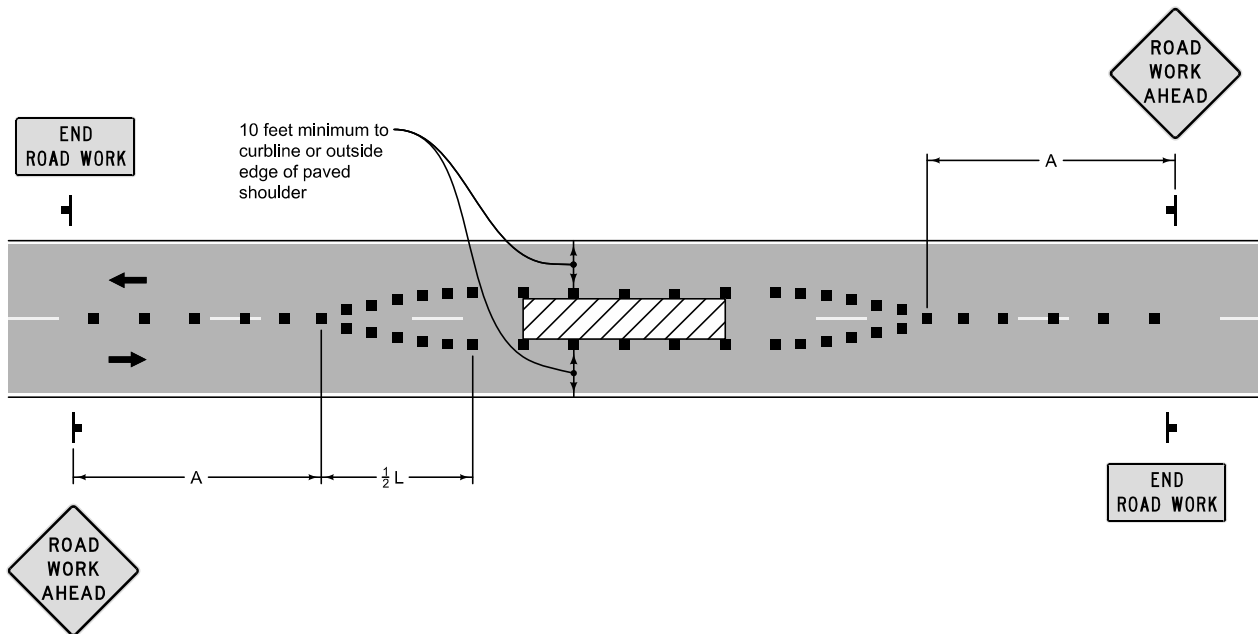

Maintain a minimum lane width on either side of the center work space of 10 feet as measured from the near edge of channelizing devices to the edge of pavement, paved shoulder, or face of curb.

A lane width of 9 feet may be used for short-term stationary work on low speed (≤ 40 mph), low volume roads when motor vehicle traffic does not include longer and wider heavy commercial vehicles.

A work vehicle displaying vehicle warning lights may be used instead of the channelizing devices forming the tapers.

Refer to Figure 8030.101 for symbol key and sign spacing.

| | | |
|---|-----------------|--------------|
|  | REVISION | |
| | New | 10-17-17 |
| | 8030.103 | |
| SUDAS Standard Specifications | | SHEET 1 of 1 |
| WORK IN CENTER OF LOW VOLUME STREET | | |

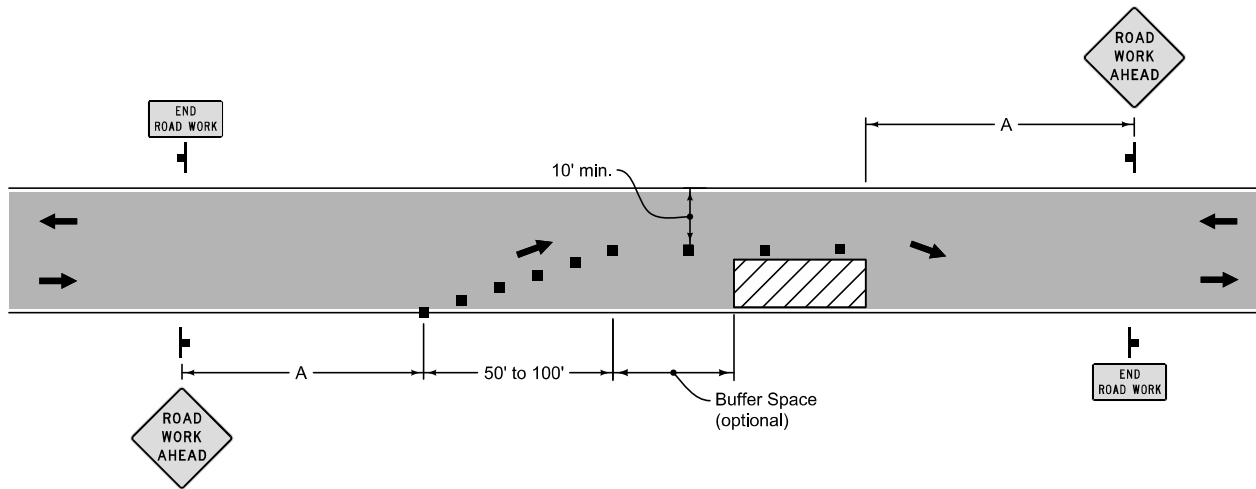

Alternate 1

Refer to Figure 8030.101 for symbol key and sign spacing.

Alternate 1

Use of Alternate 1 is restricted to low-speed roadways with good sight distance (paved or unpaved) during daylight hours.

Traffic may be self-regulating when the work space is short and drivers can see the roadway beyond.

Use one or two flaggers when motor vehicle traffic cannot effectively self-regulate.

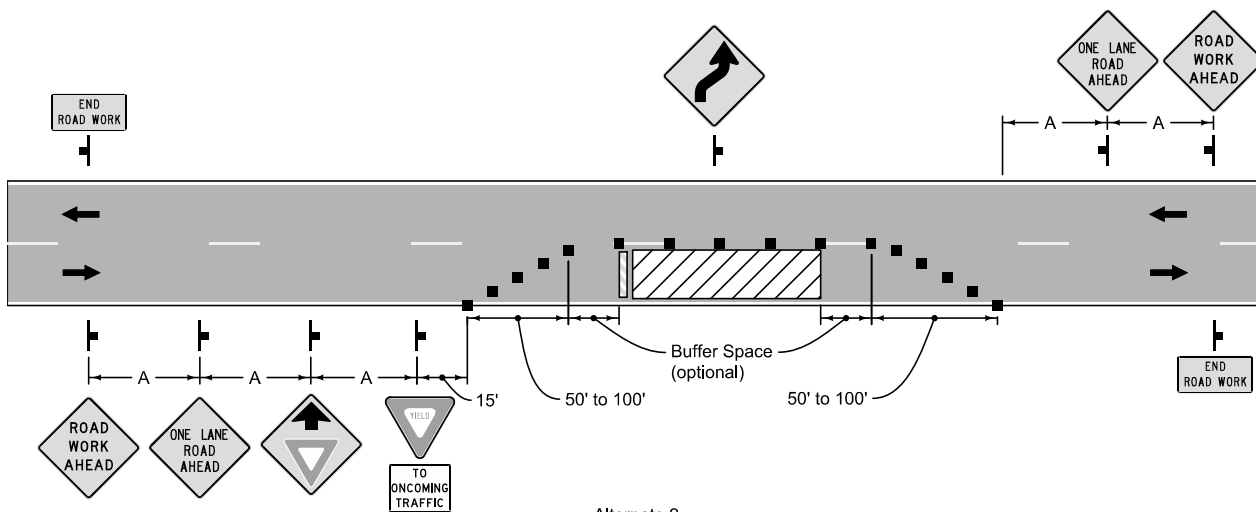

Alternate 2

Alternate 2

Use of Alternate 2 is restricted to roadways where average daily traffic is fewer than 400 vehicles and good sight distance exists.

Do not use within 2,500 feet of a similar work site.

May be used for overnight closures. During non-working hours remove materials, equipment, or stockpiled waste and fill or cover excavations.

| | |
|--------------|-----------------|
| | REVISION |
| | New 10-17-17 |
| | 8030.104 |
| SHEET 1 of 1 | |

SUDAS Standard Specifications

LANE CLOSURE ON LOW VOLUME STREET (SELF-REGULATING)

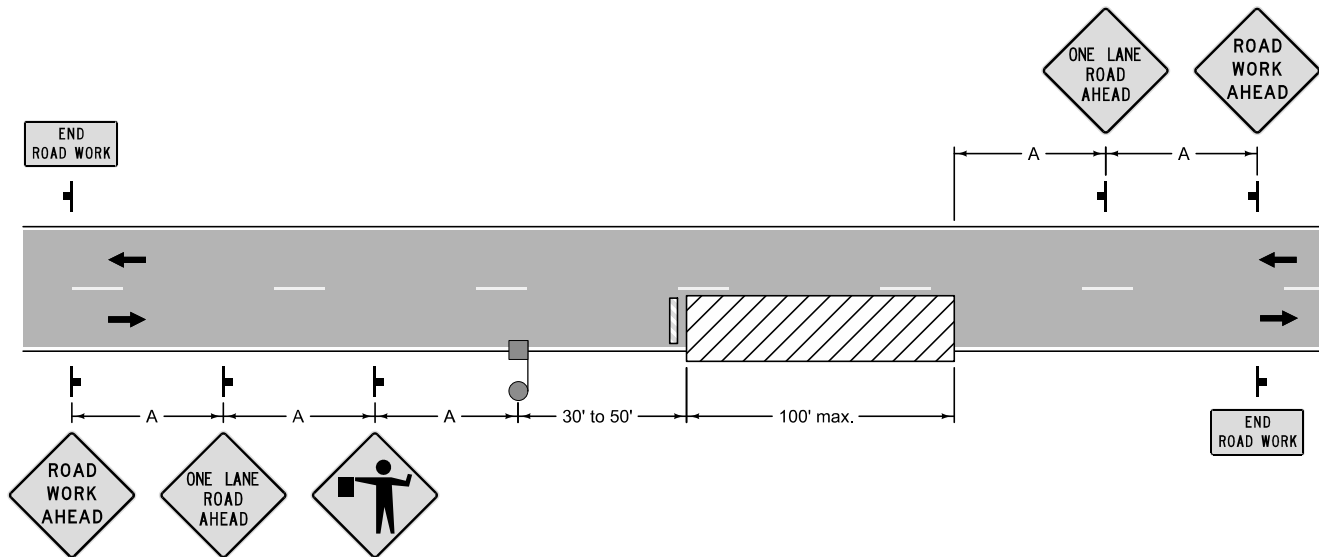

Use is restricted to roadways where average daily traffic is fewer than 2,000 vehicles per day and good sight distance exists. Use during daylight hours only.

Do not park vehicles or equipment on opposite side of work area.

A work vehicle displaying vehicle warning lights may be substituted for the Type III barricade.

Refer to Figure 8030.101 for symbol key and sign spacing.

Flagger Notes:

Allow traffic in the open lane to flow freely.

Stop the first vehicle in the closed lane from the flagger position shown, then move toward the centerline to stop other vehicles.

A second flagger may be required when the flagger's view of approaching traffic in the open lane is less than 1/4 mile or the work site is in an area of restricted sight distance (such as a No Passing Zone); and excessive traffic delays and conflicts are encountered.

If second flagger is required, refer to Figure 8030.106.

| | |
|---|--------------------------|
|  | REVISION New 10-17-17 |
| | 8030.105 |
| | SHEET 1 of 1 |
| SUDAS Standard Specifications | |
| LANE CLOSURE FOR SHORT-TERM OR MOVING OPERATIONS USING A SINGLE FLAGGER | |

An optional BE PREPARED TO STOP sign may be added between the Flagger sign and the ONE LANE ROAD AHEAD sign.

Extend the buffer space as required so the two-way traffic taper is placed before a horizontal curve (or crest vertical curve) to provide adequate sight distance for the flagger and a queue of stopped vehicles.

Refer to Figure 8030.101 for symbol key and sign spacing.

Flagger Notes:

Stop the first vehicle in the closed lane from the flagger position shown, then move toward the centerline to stop other vehicles.

Provide lighting to mark flagger stations at night.

A single flagger may be used for low volume situations with short work zones on straight roadways where the flagger is visible to road users approaching from both directions. Refer to Figure 8030.105.

Refer to Figure 8030.107 for work in vicinity of a street-rail crossing.

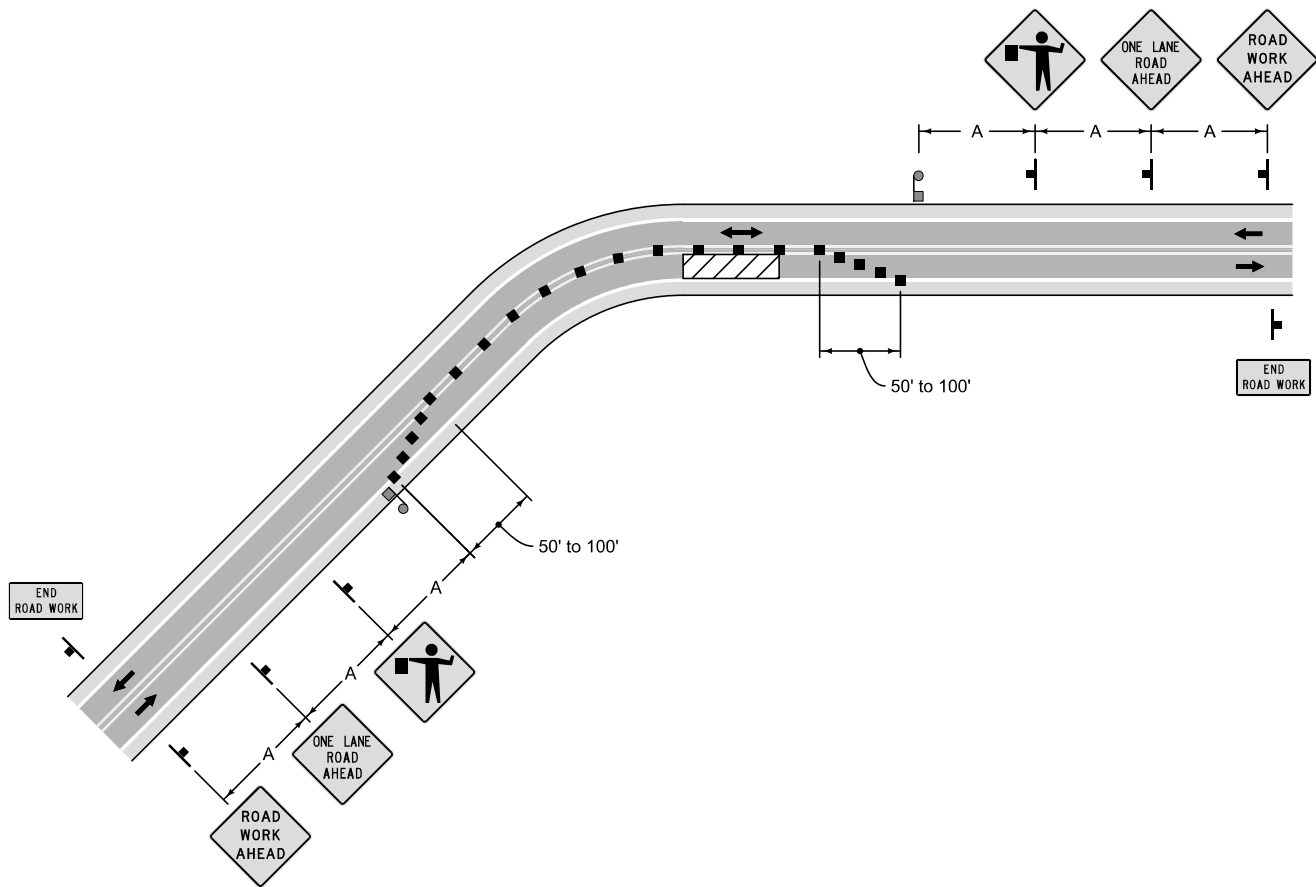

| | |
|---|-----------------|
|  | REVISION |
| | New 10-17-17 |
| | 8030.106 |
| SHEET 1 of 1 | |

SUDAS Standard Specifications

LANE CLOSURE ON TWO-LANE ROAD USING TWO FLAGGERS

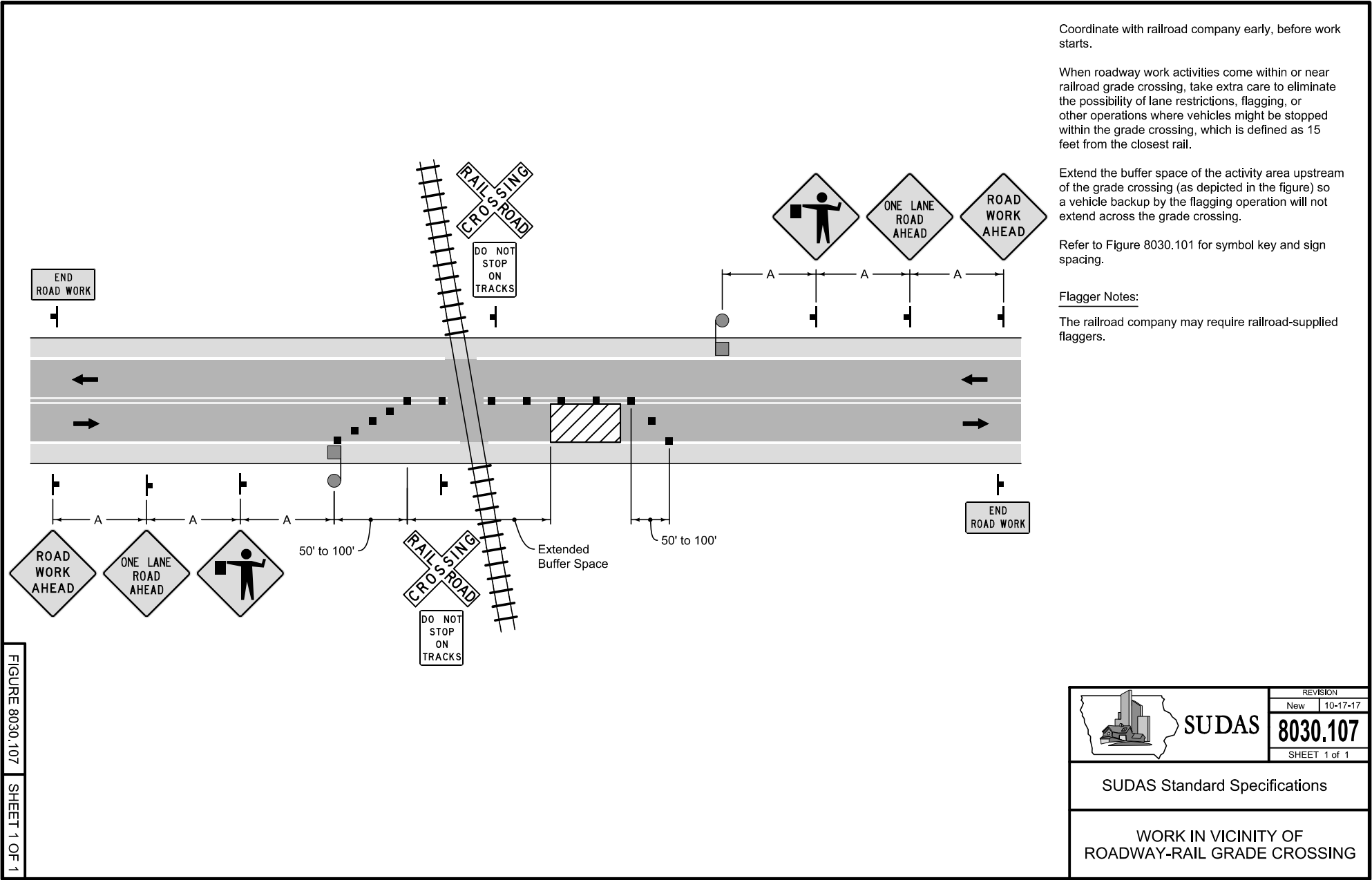

Coordinate with railroad company early, before work starts.

When roadway work activities come within or near railroad grade crossing, take extra care to eliminate the possibility of lane restrictions, flagging, or other operations where vehicles might be stopped within the grade crossing, which is defined as 15 feet from the closest rail.

Extend the buffer space of the activity area upstream of the grade crossing (as depicted in the figure) so a vehicle backup by the flagging operation will not extend across the grade crossing.

Refer to Figure 8030.101 for symbol key and sign spacing.

Flagger Notes:

The railroad company may require railroad-supplied flaggers.

FIGURE 8030.107 SHEET 1 OF 1

| | |
|---|--------------------------|
|  | REVISION New 10-17-17 |
| | 8030.107 |
| | SHEET 1 of 1 |
| SUDAS Standard Specifications | |
| WORK IN VICINITY OF ROADWAY-RAIL GRADE CROSSING | |

May be used for short-term daylight operations in urban areas on 3-lane street. Nighttime operations require additional traffic control and retroreflective sheeting.

Cones may be used as channelizing devices during daylight hours.

Flaggers and additional traffic control devices may be required for higher traffic volumes or commercial areas.

Refer to Figure 8030.101 for symbol key and sign spacing.

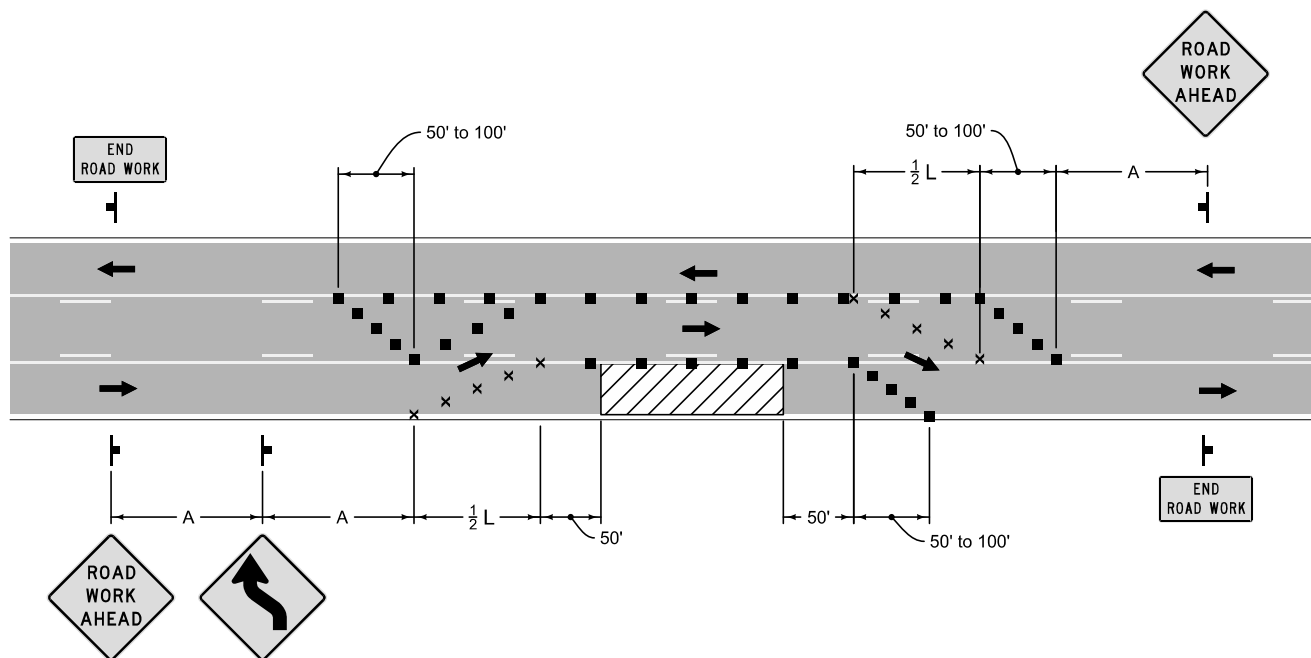

| | |
|---|-----------------|
|  | REVISION |
| | New 10-17-17 |
| | 8030.108 |
| SHEET 1 of 1 | |

SUDAS Standard Specifications

TRAFFIC CONTROL FOR OUTSIDE
LANE CLOSURE OF STREET WITH
CONTINUOUS LEFT TURN LANE

May be used for short-term daylight operations in urban areas on 3-lane or 5-lane streets. Nighttime operations require additional traffic control and retroreflective sheeting.

Cones may be used as channelizing devices during daylight hours.

Flaggers and additional traffic control devices may be required for higher traffic volumes or commercial areas.

Refer to Figure 8030.101 for symbol key and sign spacing.

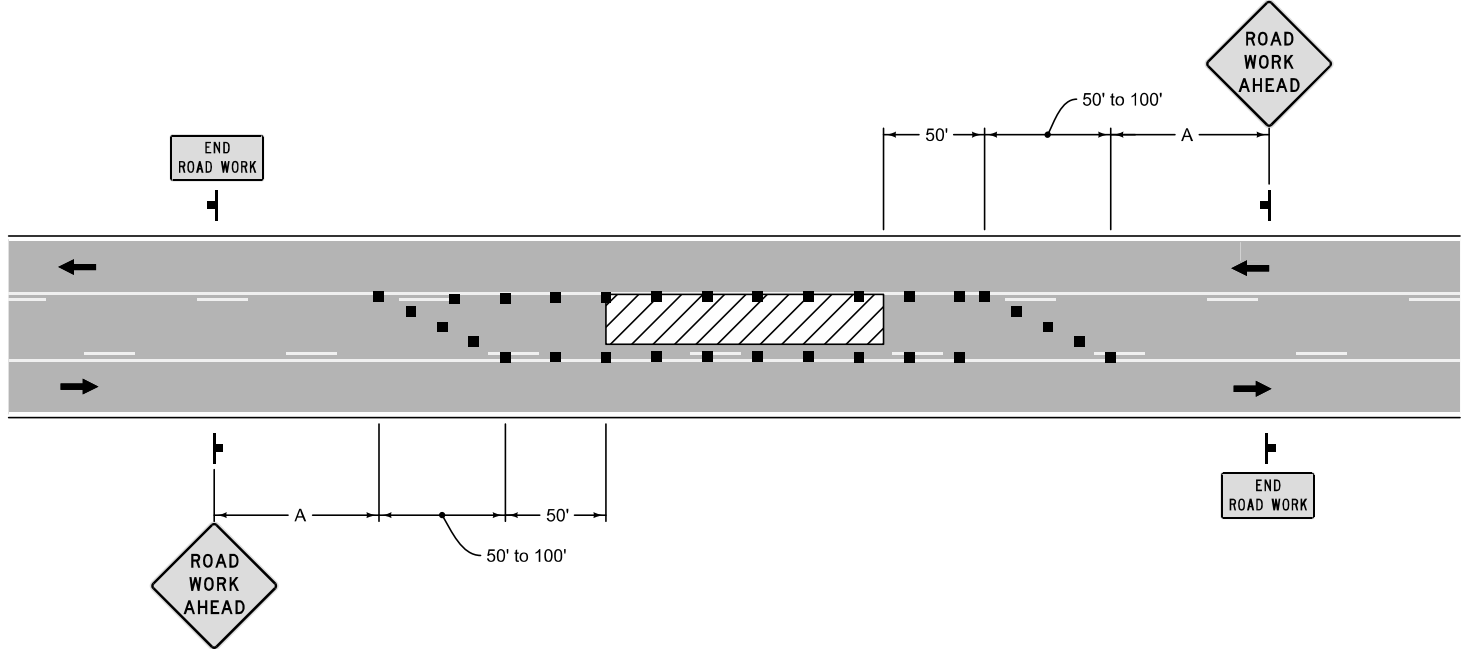

| | |
|---|--------------------------|
|  | REVISION New 10-17-17 |
| | 8030.109 |
| | SHEET 1 of 1 |
| SUDAS Standard Specifications | |
| TRAFFIC CONTROL FOR CLOSURE OF CONTINUOUS LEFT TURN LANE | |

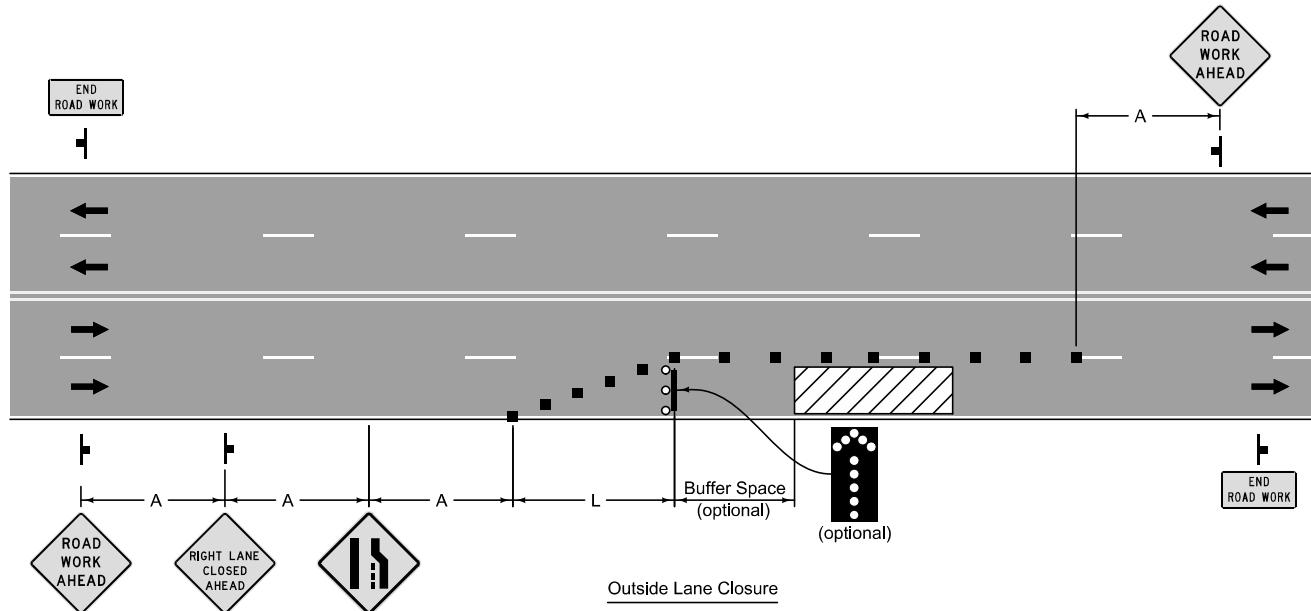

Outside Lane Closure

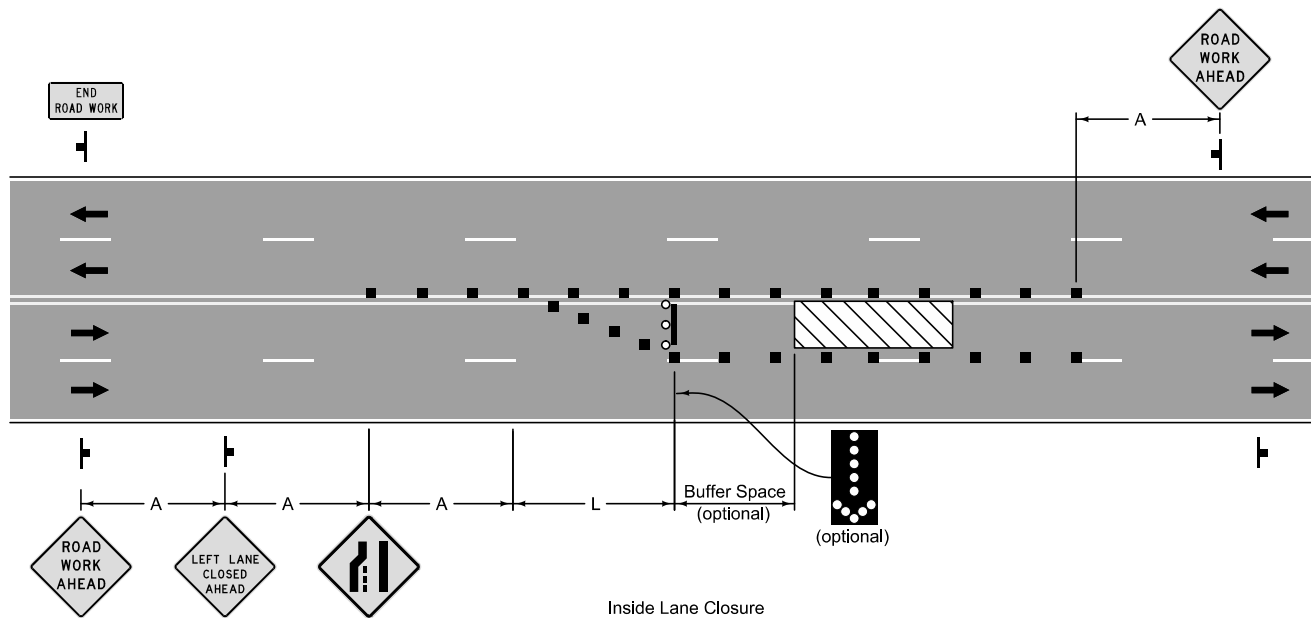

Inside Lane Closure

For low speed, low volume, urban streets the LEFT/RIGHT LANE CLOSED AHEAD sign may be omitted.

Refer to Figure 8030.101 for symbol key and sign spacing.

| | |
|---|---------------------------------|
|  | REVISION New 10-17-17 |
| | SUDAS 8030.110 |
| | SHEET 1 of 1 |
| SUDAS Standard Specifications | |
| LANE CLOSURE ON MULTI-LANE STREET | |

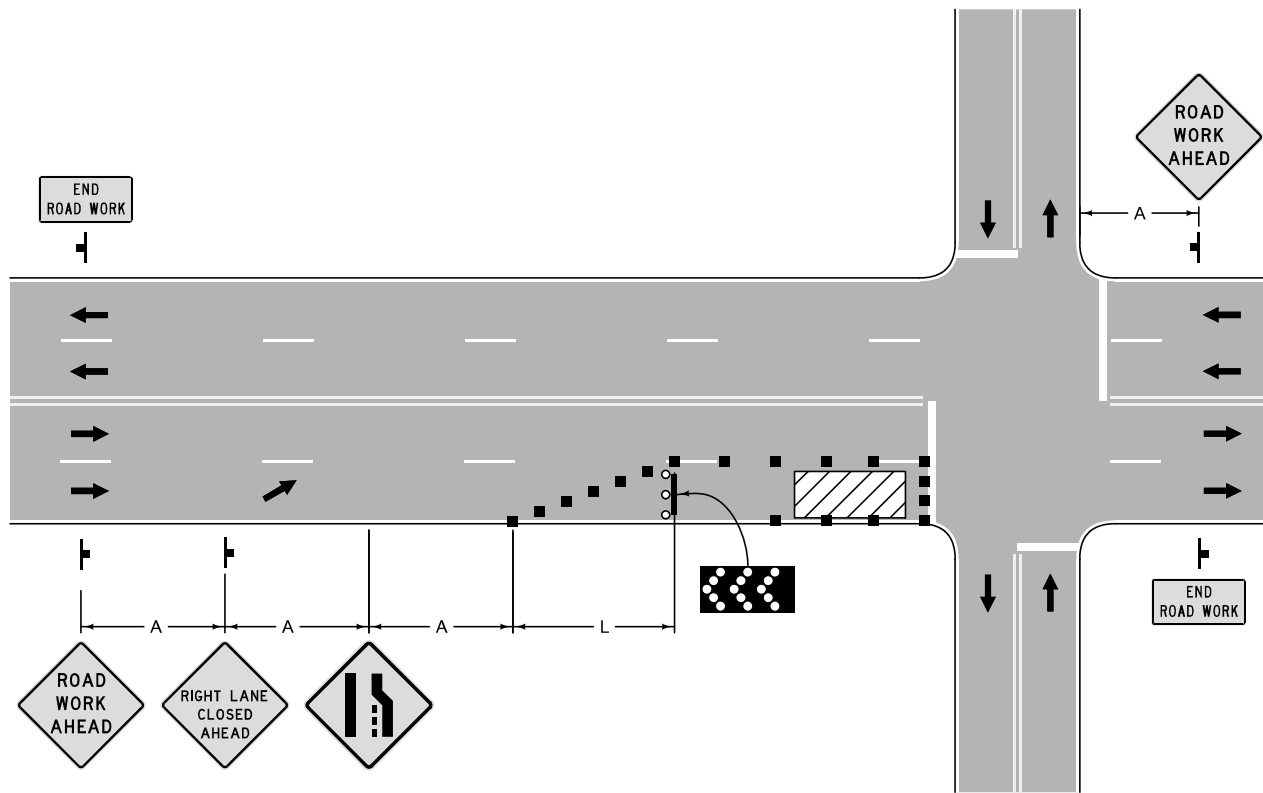

Place arrow board within the closed lane behind the channelizing devices and as close to the beginning of the taper as practical, while keeping it on the paved surface.

If the work area extends across the crosswalk, the crosswalk should be closed using appropriate information and devices.

For traffic signal maintenance, consider using law enforcement and/or a shadow vehicle.

For intersection approaches reduced to a single lane, left-turning movements may be prohibited to maintain capacity for through motor vehicle traffic.

Right lane closure shown; for left lane closure, modify sign messages and arrow board.

Refer to Figure 8030.101 for symbol key and sign spacing.

| | |
|---|--------------------------|
|  | REVISION New 10-17-17 |
| | 8030.111 |
| | SHEET 1 of 1 |
| SUDAS Standard Specifications | |
| LANE CLOSURE AT AN INTERSECTION | |

If the work area extends across the crosswalk, the crosswalk should be closed using appropriate information and devices.

For traffic signal maintenance, consider using law enforcement and/or a shadow vehicle.

Right lane closure shown; for left lane closure, modify sign messages and arrow board.

Refer to Figure 8030.101 for symbol key and sign spacing.

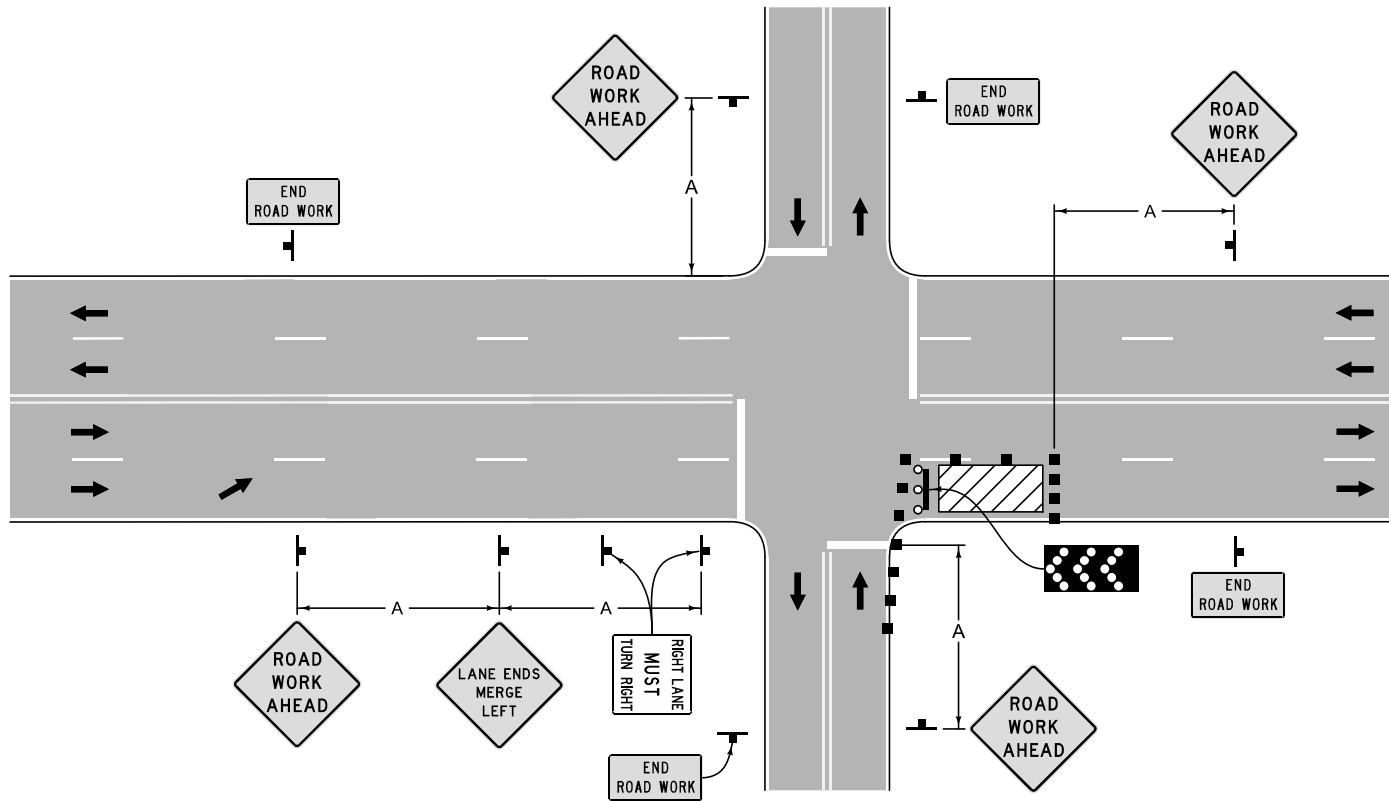

| | |
|---|----------------------------|
|  | REVISION New 10-17-17 |
| | 8030.112 |
| | SHEET 1 of 1 |
| SUDAS Standard Specifications | |
| LANE CLOSURE ON THE FAR SIDE OF AN INTERSECTION | |

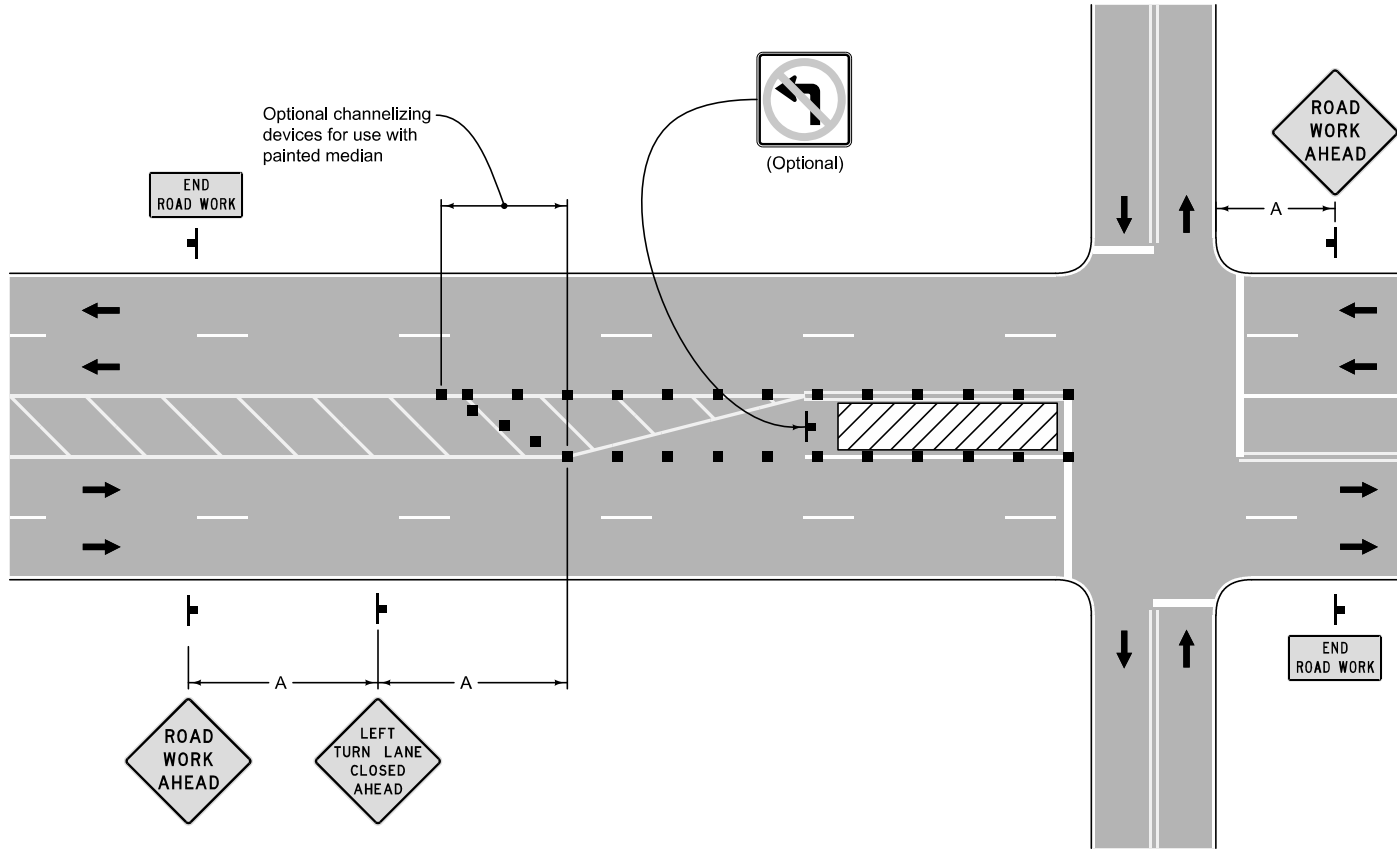

Left lane closure shown; for right lane closure, modify sign messages and channelizing devices.

For intersection approaches reduced to a single lane, left turn movements may be prohibited to maintain capacity for through motor vehicle traffic.

Prohibit left turn movements if sight distance from the through lane is restricted for left turning vehicles.

If work area extends across the crosswalk, the crosswalk should be closed using appropriate information and devices.

Refer to Figure 8030.101 for symbol key and sign spacing.

| | | |
|---|-----------------|--------------|
|  | REVISION | |
| | New | 10-17-17 |
| | 8030.113 | |
| SUDAS Standard Specifications | | SHEET 1 of 1 |
| CLOSURE OF TURN LANE | | |

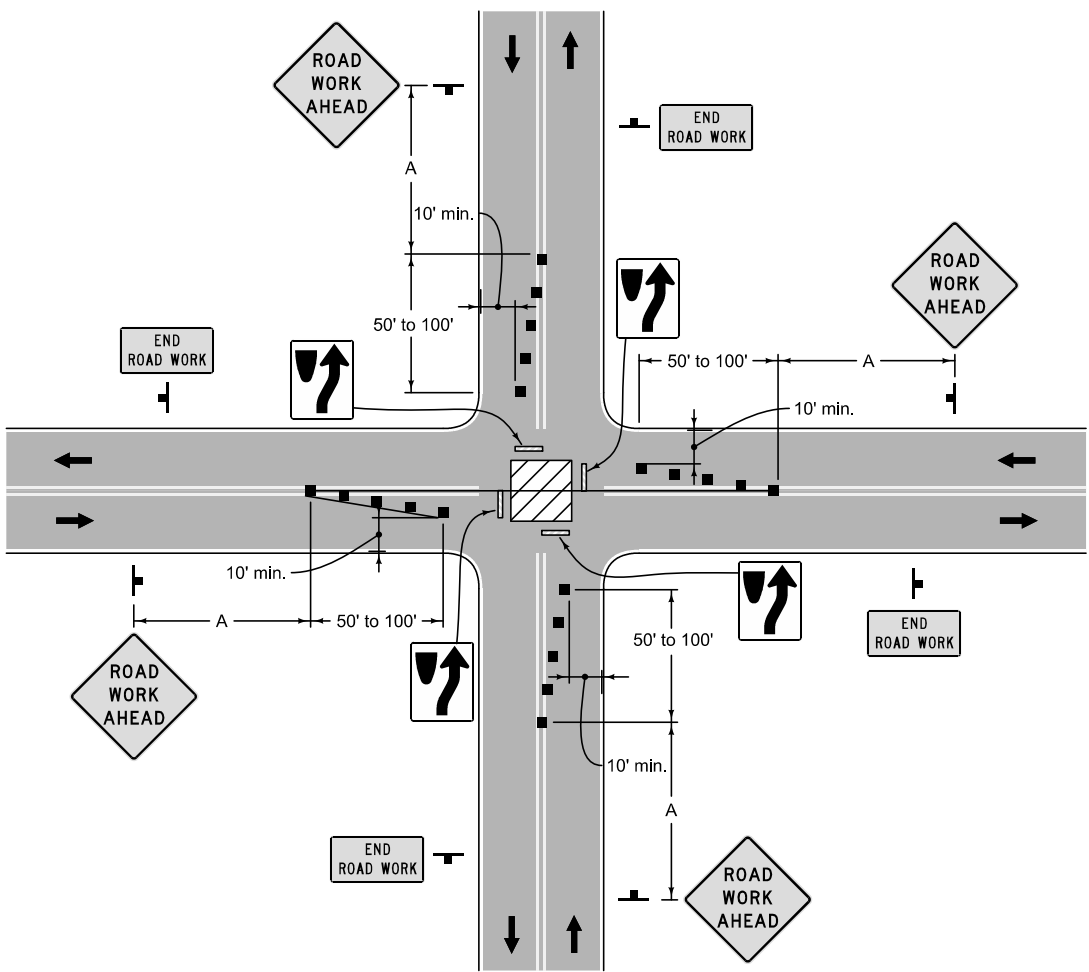

Maintain a minimum lane width of 10 feet as measured to the near face of channelizing devices. For short-term use on low speed, low volume roads without wider heavy-commercial vehicles, a minimum lane width of 9 feet may be used.

Left turns may be prohibited as required by geometric and traffic conditions.

For short-duration work, the channelizing devices may be eliminated if a vehicle displaying vehicle warning lights is positioned in the work space. Arrow signs (W1-6) may be used to replace the KEEP RIGHT signs.

Refer to Figure 8030.101 for symbol key and sign spacing.

| | | |
|---|-----------------|----------|
|  | REVISION | |
| | New | 10-17-17 |
| | 8030.114 | |
| SHEET 1 of 1 | | |
| SUDAS Standard Specifications | | |
| CLOSURE IN CENTER OF INTERSECTION | | |

Use for pavement marking and surface maintenance operations in daylight hours only.

Place vehicle-mounted signs at an elevation so they are not obscured by equipment or materials and are fully visible to approaching traffic.

Cover or turn sign legends from view when work is not in progress.

Refer to Figure 8030.101 for symbol key and sign spacing.

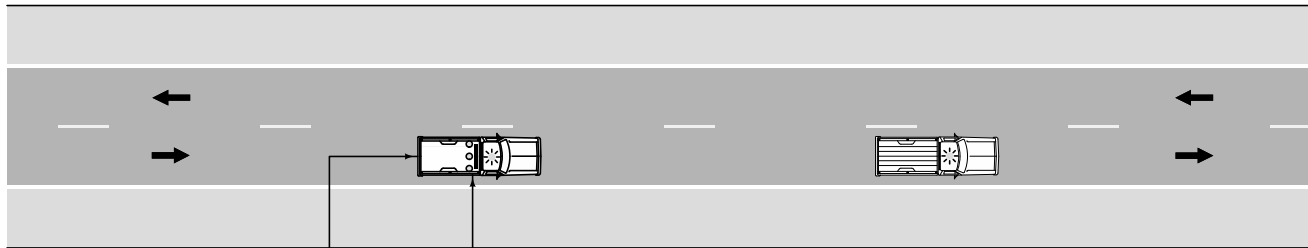

If an arrow board is used, operate in the caution mode
(optional)

Use sign shape and legend appropriate to the type of work.
Examples include:



| | | |
|---|-----------------|----------|
|  | REVISION | |
| | New | 10-17-17 |
| | 8030.115 | |
| SHEET 1 of 1 | | |
| SUDAS Standard Specifications | | |
| MOVING OPERATIONS ON TWO LANE ROADS | | |

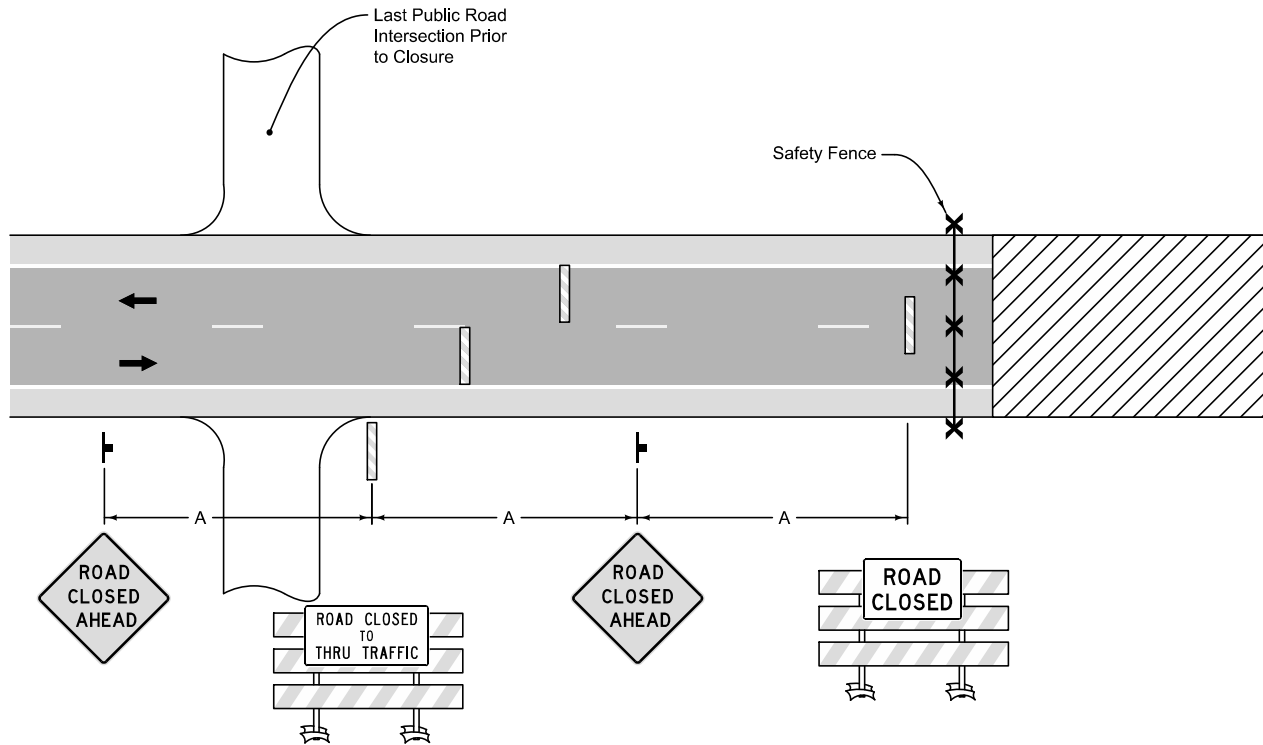

When distance "A" is less than 500 feet, place the barricade with the ROAD CLOSED TO THRU TRAFFIC sign in the middle of the traffic lane approaching the work area. The barricade may be omitted if the distance to the work area is less than 250 feet.

Maintain safety fence closures to prevent unauthorized vehicles from passing through.

Place staggered Type III barricades in the roadway after the last public road intersection prior to the closure.

If local traffic is allowed to pass a Type III barricade, retroreflective sheeting is required on both sides of the barricade.

Refer to Figure 8030.101 for symbol key and sign spacing.

| | |
|---|---------------------------------|
|  | REVISION New 10-17-17 |
| | SUDAS 8030.116 |
| | SHEET 1 of 1 |
| SUDAS Standard Specifications | |
| STREET OR ROAD CLOSURE | |

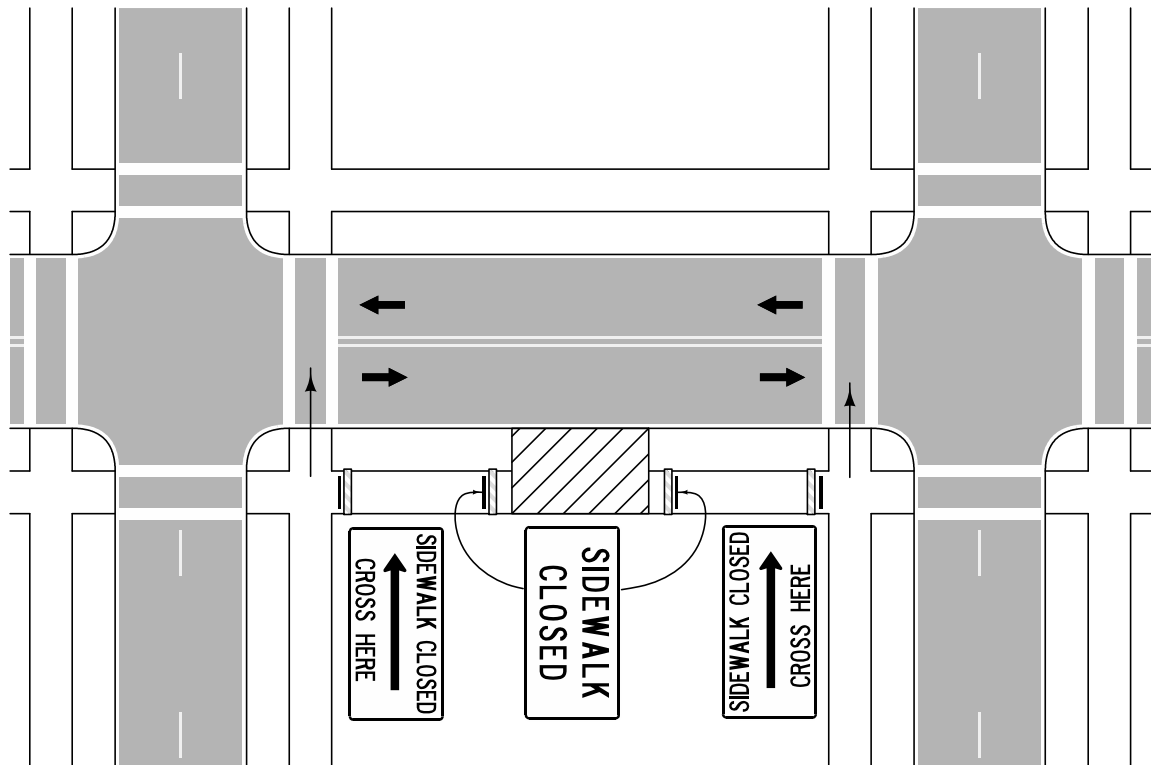

Use when crosswalks, sidewalks, or other pedestrian facilities are closed or relocated. Ensure temporary facilities are detectable and include accessibility features consistent with the features present in the existing pedestrian facility.

Signs such as KEEP RIGHT (LEFT) may be placed to guide or direct pedestrians.

Provide continuous barriers or fencing complying with the requirements of PROWAG to secure work areas from pedestrians.

When required in the contract documents, provide auxiliary lighting or audible information devices to assist pedestrians with visual disabilities.

Only the temporary traffic control devices related to pedestrians are shown. Other devices related to control of vehicular traffic may be necessary.

Refer to Figure 8030.101 for symbol key and sign spacing.

| | |
|---|--------------------------|
|  | REVISION New 10-17-17 |
| | 8030.117 |
| | SHEET 1 of 1 |
| SUDAS | |
| SUDAS Standard Specifications | |
| SIDEWALK DETOUR | |

Use when crosswalks, sidewalks, or other pedestrian facilities are closed or relocated. Ensure temporary facilities are detectable and include accessibility features consistent with the features present in the existing pedestrian facility.

Provide continuous barriers or fencing complying with the requirements of PROWAG to secure work areas from pedestrians.

Where pedestrians are diverted onto high-speed roadways, provide a temporary traffic barrier and, if specified in the contract documents, a crash cushion, to separate the temporary sidewalk from vehicular traffic.

When required in the contract documents, provide auxiliary lighting or audible information devices to assist pedestrians with visual disabilities.

Only the temporary traffic control devices related to pedestrians are shown. Other devices related to control of vehicular traffic may be necessary.

Refer to Figure 8030.101 for symbol key and sign spacing.

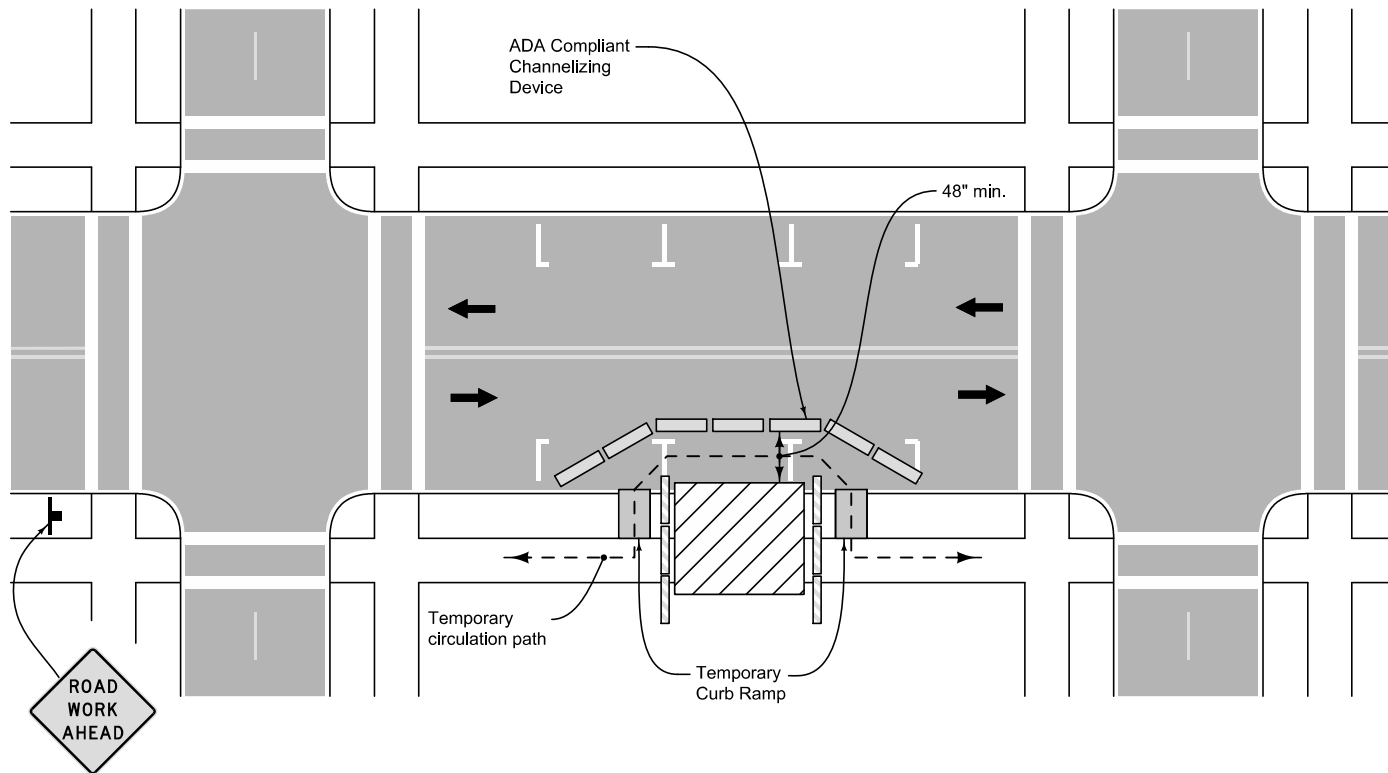

| | | |
|---|-----------------|--------------|
|  | REVISION | |
| | New | 10-17-17 |
| | 8030.118 | |
| SUDAS Standard Specifications | | SHEET 1 of 1 |
| SIDEWALK DIVERSION | | |

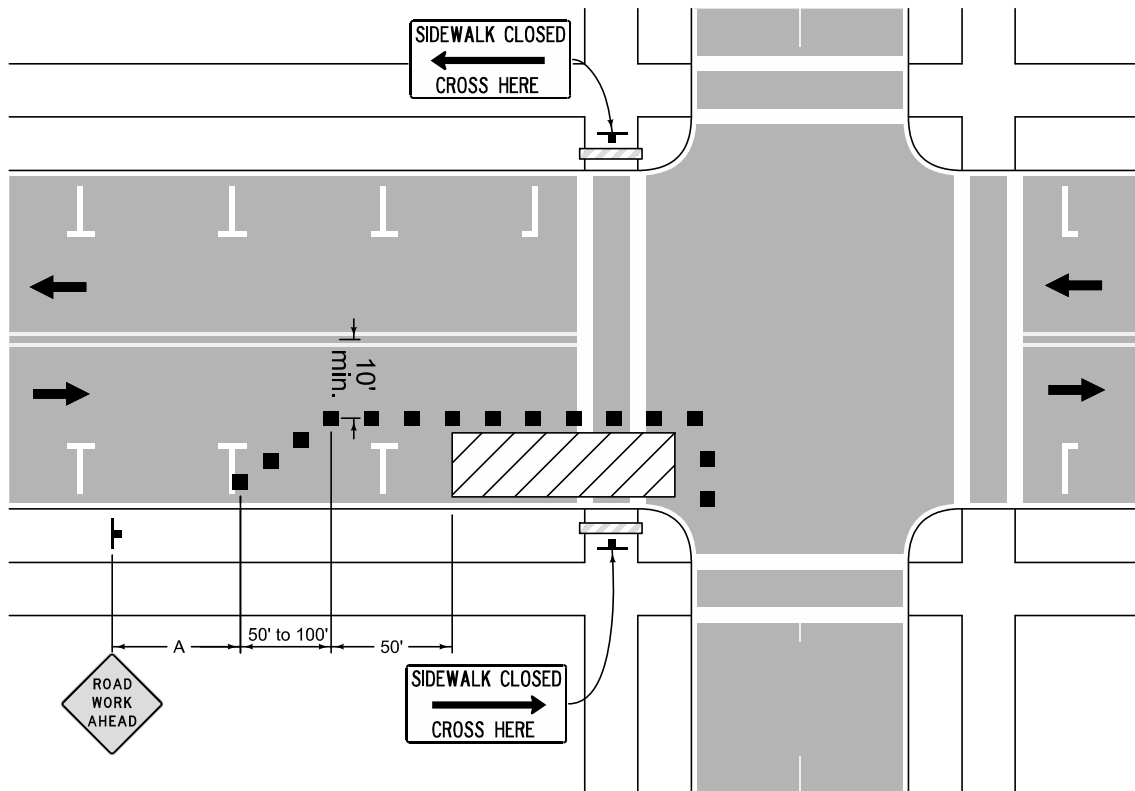

Use when work activities close crosswalk or reduce width to less than 4 feet. Ensure temporary facilities are detectable and include accessibility features consistent with the features present in the existing pedestrian facility.

When required in the contract documents, provide auxiliary lighting or audible information devices to assist pedestrians with visual disabilities.

Refer to Figure 8030.101 for symbol key and sign spacing.

| | |
|---|---------------------------------|
|  | REVISION New 10-17-17 |
| | SUDAS 8030.119 |
| | SHEET 1 of 1 |
| SUDAS Standard Specifications | |
| CLOSURE OF MARKED OR UNMARKED CROSSWALK | |

