

# Methods of New Construction

## A. Trenchless Methods for New Construction

The trenchless construction methods available for new facilities are divided into two main classes: Horizontal Earth Boring, which is performed without workers being inside the borehole, and Pipe Jacking / Utility Tunneling, which require workers inside the borehole during the excavation and casing processes. The chart below illustrates the various methods available.

**Figure 14B-2.01:** Classification of Trenchless Construction Methods

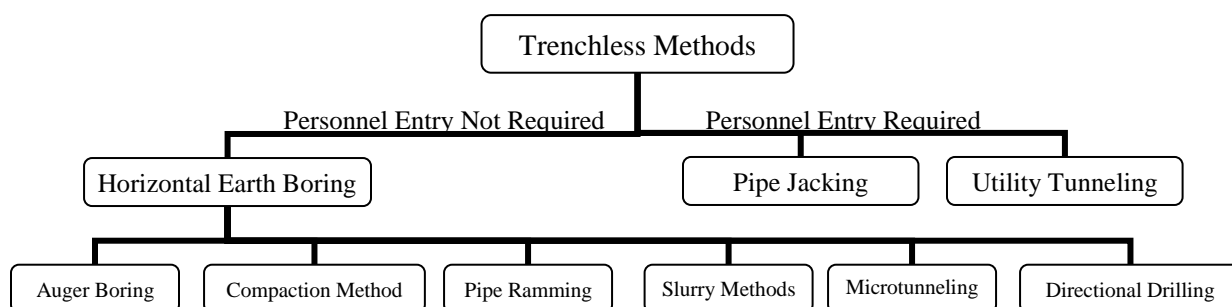

## B. Expected Service Life for New Construction

The expected service life for a new pipe or other type of product installed by boring or tunneling is generally the same as a similar material installed by open cut methods. Due to the possibility of over-excavation, there may be some potential for surface settlement as the over-excavated bore settles around the casing pipe. This is especially true for shallow bores.

## C. Auger Boring

- Description of Process and Equipment:** Auger boring is accomplished with an auger boring machine by jacking a casing pipe through the earth while at the same time removing earth spoil from the casing by means of a rotating auger inside the casing.

The typical auger boring installation begins with the installation of bore pits at the beginning and end of the proposed bore. Bore pit dimensions vary depending on the size and length of the casing being used and on the depth of the boring. Generally, the length varies from 26 to 40 feet long and 8 to 12 feet wide. The bottom of the bore pit is usually over-excavated and backfilled with crushed stone in order to provide adequate support for the equipment.

Most auger boring equipment is track mounted. The boring machine slides along this track in order to advance the casing pipe. The master track (on which the boring machine is set) is placed in the pit and set to the required line and grade of the bore. This is a critical step in the auger boring process since there is little ability to correct line or grade deviations once an auger bore is started. Steerable auger boring equipment is now common and does allow for some minor adjustment or bore direction as it progresses; however, proper setup is still critical.

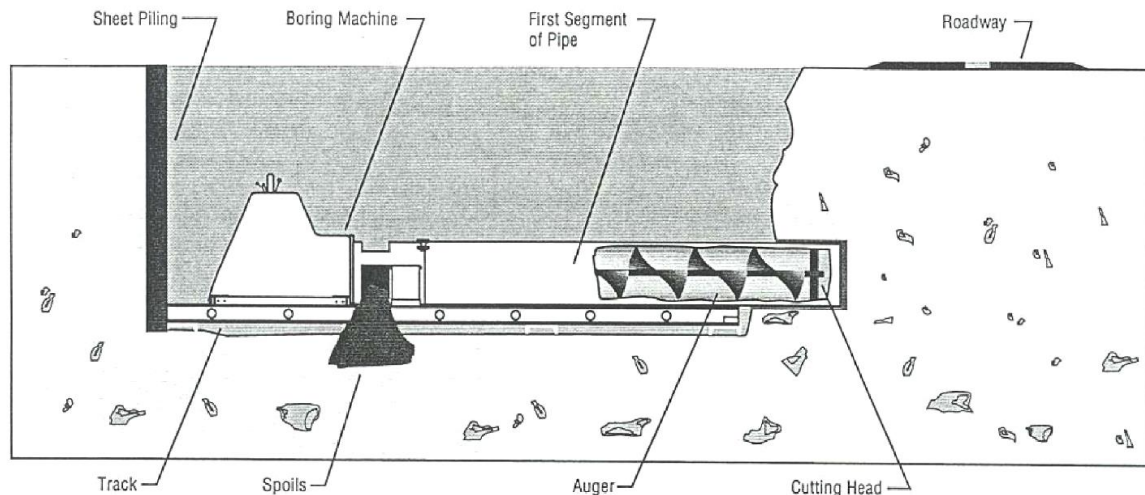
**Figure 14B-2.02:** Typical Auger Boring Setup

Source: Isley and Gokhale, 1997

The boring machine applies thrust in order to advance the carrier pipe. This thrust is applied against the back of the boring pit with hydraulic rams. In order to withstand this thrust, a backing plate is normally installed against the back wall of the boring pit. This backing plate normally consists of steel piling, a steel plate, or wooden timbers. For long or large diameter bores, a concrete backstop may be used in addition to a steel plate.

After installation of the master track and backing plate, the auger boring machine is set on the master track. A cutting head, compatible with the soil conditions expected, is installed on the front of the first auger section. The first section of casing pipe may have a steel band welded around the top 3/4 of the outside diameter of the pipe. This process, called banding, slightly over-excavates the borehole, thereby reducing skin friction on the following casing sections.

The bore is begun by carefully installing the first section of casing pipe to the correct line and grade. After the first section has been installed and checked for accuracy, the boring machine is disconnected from the casing pipe and auger and slid to the rear of the bore pit. The next section of casing pipe and auger are lowered into position. The second auger section is coupled to the first with an auger pin. The two casing sections are lined up and either welded together, or an interlocking casing pipe jointing system may be utilized.

The bore is then advanced by applying thrust and simultaneously rotating the flight augers inside the casing in order to remove spoil. This process is repeated until the required length of casing is installed.

Once the bore is completed, the cutting head is removed at the receiving pit, and the augers are pulled out at the entrance pit, disconnected, and removed.

If required, a carrier pipe can be installed. The carrier pipe is attached to pre-manufactured casing chocks. The carrier pipe is pushed into the casing pipe using the auger boring machine, or by pulling it through with a winch.

Most auger bores are done without the ability to steer the bore, that is, make line or grade adjustments once the bore has begun. However, equipment and techniques are available that do allow minor corrections or changes in alignment to be made.

2. **Typical Applications/Materials:** The auger boring technique is used extensively throughout every segment of the United States, and it is the most common method used for crossing roadways with storm sewer, sanitary sewer, or water main pipes.

In auger boring, the auger rotates inside the casing as it is being jacked. Consequently there is a danger that any interior pipe coatings may be damaged by the process. Due to the rotating augers and spoil removal process the interior of the casing pipe is subjected to during installation, the standard casing material used for auger boring is steel.

Normally, a carrier pipe is installed inside of the casing pipe. This carrier pipe is protected by the structural rigidity of the steel casing and can therefore be almost any standard pipe material.

3. **Range of Applications:**

- a. **Pipe Sizes and Bore Lengths:** The most common pipe sizes installed by auger boring are from 8 inches to 36 inches. For sizes smaller than 8 inches, slurry and compaction methods are more suitable and economical, especially where the line and grade are not critical. For diameters larger than 36 inches, where the line and grade are more critical, pipe jacking with tunnel boring machines provide greater accuracy and safety and may be more cost effectively.

This method was initially developed for bores between 40 and 70 feet, just long enough to cross under a two lane roadway. Since that time, advances in equipment capabilities have extended the range of this method. Typical bore lengths now ranges between 175 feet and 225 feet, with maximum bore lengths of greater than 600 feet possible.

- b. **Soil Conditions:** Auger boring methods can be used in a wide variety of soil conditions. However, soils with large boulders can cause problems with this method. Since the spoil is removed through the casing with an auger, any materials encountered must be able to fit between the auger flights in order to be carried out. In general, the largest boulder or other obstacle that this method can handle is limited to one third of the nominal casing diameter.

In addition, auger boring in sandy, cohesionless soils can be difficult and may cause settlement, if not done properly, due to a loss of ground ahead of the bore as the soil flows into the pipe.

- c. **Tolerances:** The accuracy achievable with auger boring methods is usually  $\pm 1\%$  (both vertically and horizontally) of the length of the bore. Equipment, which allows the auger bore to be steered, is accurate within  $\pm 0.1\%$  vertically and  $\pm 1.0\%$  horizontally.

## D. Compaction Boring

1. **Description of Process and Equipment:** Compaction boring is a method of forming a borehole by displacing and compacting the soil radially, rather than removing the soil. The compaction method can be divided into three sub classifications: the push rod method, the rotary method, and the percussion method.
  - a. **Push Rod Method:** The first type of compaction boring, the push rod method, consists of a machine that pushes or pulls a solid rod through the soil by hydraulic force, simply displacing the soil. The resulting bore hole is the same diameter as the rod. Typical rod diameters range from 1 3/8 to 1 3/4 inches. To further enlarge the hole, the machine can pull a reamer back through the hole. Rods are usually about 4 feet in length and can be linked in series to

achieve the desired bore length. Once the borehole is formed, a cable is used to pull the product into place.

- b. **Rotary Method:** The rotary method is similar to the push rod method; however, the rod used is similar to a drill bit. It is rotated as it is forced horizontally through the soil.
- c. **Percussion Method (Impact Molding):** The percussion method, also called impact moling, uses a self-propelled “mole” that is normally pneumatically powered. The mole is a torpedo shaped device that contains a reciprocating hammer in the nose. The action of this piston creates an impact force that propels the mole forward through the ground. Depending on ground conditions, the tools typically travel at a rate of 3 inches to 4 feet per minute. Once the mole exits into the receiving pit, the mole is removed and the air lines are used to pull a cable back through the borehole. This cable can then be used to pull the pipe product into place. If a rigid pipe is to be installed, it is simply pushed through the open borehole.

**Figure 14B-2.03:** Typical Percussion Setup

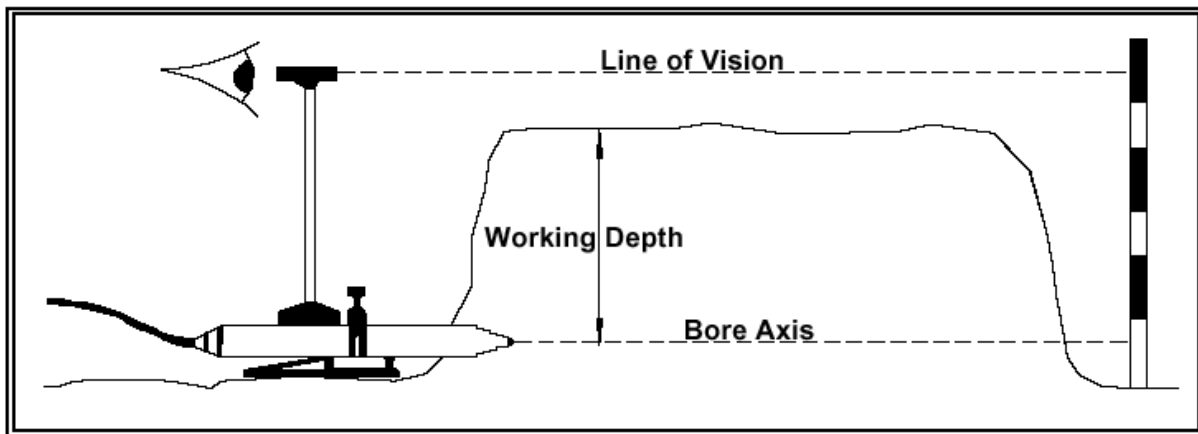

Source: Simicevic and Sterling, 2001

2. **Typical Applications/Materials:** Compaction boring methods are commonly used for installation of electric and communications cables, as well as gas lines, sprinkler irrigation systems, and water service lines. Since the boring process is independent of the pipe insertion process, almost any small diameter pipe or line can be installed by these methods.
3. **Range of Applications:**
  - a. **Pipe Sizes and Bore Lengths:** The size of product that can be installed by compaction methods is limited to the size of borehole that can be formed by the compaction method selected. The typical limit is 6 inches or less.

The size is further limited by the potential for ground disturbance above the bore. Since these compaction methods compress the surrounding soil and do not remove spoil, there is a potential for heaving. In order to avoid heaving problems, a rule of thumb to follow is to provide one foot of cover for every inch of bore diameter.

Due to the inaccuracy of the method and inability to control the direction of the bore, installation lengths are limited. The maximum practical bore length is typically 40 to 60 feet.

- b. **Soil Conditions:** Since these methods compact the soil around the borehole, moderately soft to medium hard compressive soils are best suited for these methods.

Rocks, boulders, and other obstacles can affect the accuracy the bore and cause it to stray away from the desired course.

- c. **Tolerances:** As mentioned previously, the accuracy of installation depends greatly on initial setup and ground characteristics. Once the bore is begun, there is no ability to control the direction of the bore. These methods are not normally used to install lines, which require a high degree of accuracy such as sanitary sewer lines.

- 4. **Relative Cost vs. Other Trenchless Methods:** Compaction methods for boring are highly economical. The equipment investment compared to other boring methods is very low. For short distance, small diameter bores, compaction methods are normally the lowest cost trenchless option available.

## E. Pipe Ramming

- 1. **Description of Process and Equipment:** Pipe ramming is a trenchless method of installing a steel pipe or casing using a pneumatic tool to hammer the pipe or casing into the ground.

The pipe can be rammed with the leading edge either open or closed. Pipes up to 8 inches can be rammed with the end closed; however, this method is more difficult and is not normally recommended. When a closed end pipe is driven, the surrounding soil is displaced and compacted similar to the compaction methods previously described. This can result in ground heaving and is more susceptible to obstructions. More commonly, and always for larger diameters, the leading edge is left open. With the end of the pipe open, soil is allowed to enter the pipe during installation.

The lengths of pipe that can be rammed depend mainly on the space available at the site. If adequate room is available, the entire length of pipe can be welded together prior to installation and rammed as a single unit. When the available area is restricted, the pipe can be rammed in short sections, welding them together as the bore progresses.

A typical Pipe ramming installation begins with the installation of bore pits at the beginning and end of the proposed bore. Guide rails are set to the line and grade of the proposed bore. The first length of steel pipe is prepared by attaching a steel band around the outside of the leading edge of the pipe. The purpose of this band is to slightly overexcavate the borehole, thus reducing friction on the following pipe sections. The first section of pipe is set in place, and the ramming hammer is attached to the rear of the pipe. The ramming hammer's percussion force drives the steel pipe into the ground along the line dictated by the guide rails. When one section of pipe has been driven, the hammer is removed and, if necessary, the next length of pipe is welded in place. This process is repeated until the leading edge of the pipe arrives at the receiving pit.

When using an open-ended pipe, a cylinder of ground, equal to the pipe diameter, is forced into the pipe as the bore advances. Once the bore is completed, this spoil must be removed. There are several methods available to remove this spoil including auger, compressed air, or water jetting.

Figure 14B-2.04: Typical Open-face Pipe Ramming Setup

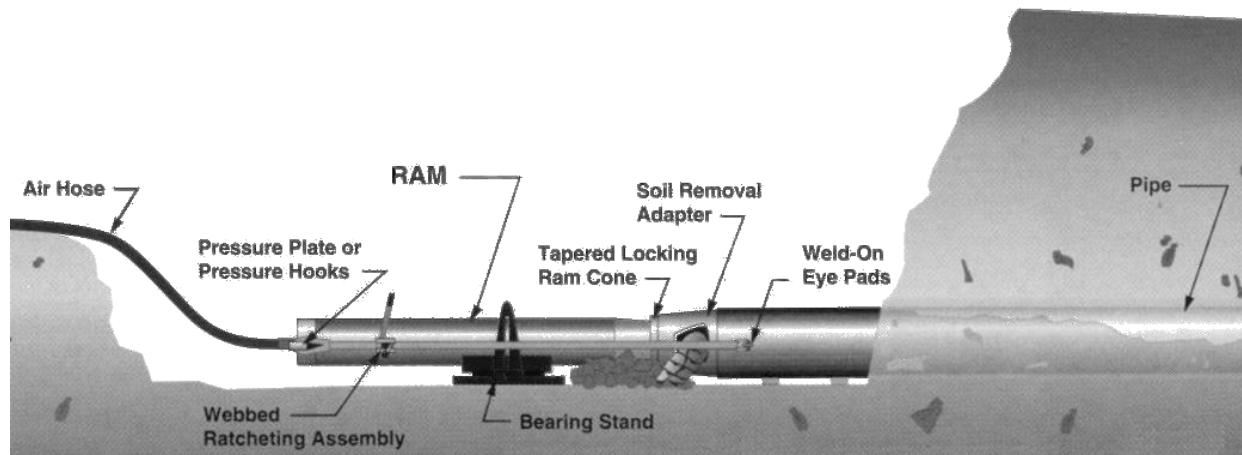

Source: ACCU-Pipe Ramming Systems Inc.

2. **Typical Applications/Materials:** This method is frequently used under railway and road embankments for installation of medium to large diameter pipes.

Steel pipe is used for the casing, as no other material is strong enough to withstand the impact forces generated by the hammer. Upon completion, a carrier pipe can be installed inside of the steel casing pipe. This carrier pipe is protected by the structural rigidity of the steel casing and can, therefore, be almost any standard pipe material.

3. **Range of Applications:**

- a. **Pipe Sizes and Bore Lengths:** Common pipe sizes installed by ramming range from 2 inches to 55 inches; however, pipe sizes as large as 147 inches have been done.

Pipe ramming is typically used for pipe installations over relatively short distances, usually less than 150 feet. However, lengths as long as 300 feet may be successfully installed.

- b. **Soil Conditions:** Pipe ramming can be used in almost all types of soil conditions except solid rock. Pipe ramming is generally more successful than auger boring in rocky ground, as the leading edge and percussion force tends to act as a splitter to fracture the cobbles that are encountered.
- c. **Tolerances:** Pipe ramming is a non-steerable method. Once the bore has begun, there is little control over the line and grade of the installation. Soil conditions and ground obstructions such as rocks and cobbles can cause the bore to stray from the intended line and grade. The accuracy of the pipe ramming method is usually better than  $\pm 1\%$  (both vertically and horizontally) of the length of the bore.

4. **Relative Cost vs. Other Trenchless Methods:** Compared to other trenchless methods such as augering and directional drilling, pipe ramming can save both installation time and costs under appropriate conditions. Installation time may be shorter than for augering because the required bore pits are smaller and actual installation is faster. Pipe ramming is generally less costly than directional boring for short bores of 60 feet or less; however, directional drilling is generally better suited for longer bores.

## F. Slurry Methods

- 1. Description of Process and Equipment:** Slurry methods involve the use of a drilling fluid, such as water or bentonite slurry to aid in the drilling process and spoil removal.

Slurry methods can be divided into two classifications: slurry boring and water jetting.

- a. Slurry Boring:** Slurry boring normally begins by constructing a bore pit. The boring machine is set in the pit and adjusted to the appropriate line and grade. A pilot hole is formed by advancing drill tubing, with a drill bit attached to the end, through the ground. As the bit is advanced, drilling fluid is pumped through the tubing to the drill bit in order to lubricate the pilot drill and reduce the friction created by the advancing bore. Once the pilot bore reaches the receiving pit, a back reamer can be pulled or a forward reamer can be pushed through the ground to increase the bore to the required diameter.

As the reamer is forced through the ground, drilling fluid is pumped into the bore. Depending on soil type, this drilling fluid may be either water or a bentonite mixture. The soil is mechanically cut by the reamer and mixed with the drilling fluid. These cuttings are held in suspension forming a slurry. This slurry helps prevent the uncased borehole from collapsing by exerting hydrostatic pressure against the walls of the bore.

After the reaming process is completed, the bore is swabbed by pulling a plug through the bore, thereby forcing the slurry and cuttings out of the borehole. A casing pipe is inserted in conjunction with, or shortly after, the swabbing process.

The size of the borehole is larger than the outside diameter of the casing pipe. The void between the pipe and the bore should be filled with grout to prevent ground settlement above the bore.

- b. Water Jetting:** Another method of forming a borehole is the water jetting method. As the name implies, water jetting relies on a high speed jet of water to liquefy and remove soil. A special nozzle is attached to the end of a rod and extended forward into the bore. The jet of high-pressure water is used to perform all of the cutting and to wash the cuttings out of the bore. There is little ability to control the direction of the bore, since the jet of water will follow the path of least resistance. There is also little control over the amount of material excavated by the process and over-excavation is inevitable. Over time, this over-excavation will cause ground settlement. Due to these reasons, water jetting is rarely allowed by most jurisdictions.

A distinction between water jetting and slurry boring should be made. Water jetting uses the force of water to erode the borehole and, therefore, is generally not recommended. Slurry boring is a mechanical process, and jetting of the soil should not occur if performed correctly.

- 2. Typical Applications/Materials:** Since the boring process is independent of the pipe insertion process, almost any type of casing or carrier pipe can be installed by slurry methods.

Slurry methods are most commonly used for placing non-gravity flow installations. Gravity flow sewers with sufficient grade may be successfully installed by this process; however, there may be some difficulty maintaining a straight grade alignment due to the tendency of the bore head to drop as the bore advances.

Some jurisdictions may prohibit the use of slurry methods because, until the casing pipe is inserted, the bore is unsupported.

### 3. Range of Applications:

- a. Pipe Sizes and Bore Lengths:** This method is most commonly used for small diameter bores. Pipe sizes between 2 inches to 12 inches are the most common.

Due to the inability to steer the bore head, slurry methods are typically used for relatively short bores ranging from 40 to 75 feet.

- b. Soil Conditions:** While the process for completing the bore may vary based upon the soil types, slurry boring can be utilized under most ground conditions.
- c. Tolerances:** Slurry boring is a non-steerable method that depends greatly on the operator's skill. For stable, homogeneous soil conditions, bores up to 60 feet can be expected to be within  $\pm 1\%$  (both vertically and horizontally) of the length of the bore.

## G. Horizontal Directional Drilling

- 1. Description of Process and Equipment:** Horizontal directional drilling can be divided into two main classes, Mini-HDD and HDD, based upon the size of the product being installed and the length of the bore. Mini-HDD is for drive lengths of less than 600 feet and pipe sizes up to 10 inches in diameter. Pipe diameters between 12 and 60 inches and pipe lengths over 2,000 feet can be installed by HDD. The distinction between Mini-HDD and HDD is made mainly due to the types of equipment involved.

Mini-HDD systems are used extensively in the private utility industry for installing power lines, telecommunications cables, or gas lines at shallow depths. Mini-HDD equipment normally consists of an all-in-one, self-powered unit, which may be mounted on tracks and can be transported on a single trailer. The HDD systems used to install larger pipe diameters are monsters by comparison. These systems may occupy a space as large as 150 feet by 250 feet and arrive on the jobsite in as many as 10 trailers.

**Figure 14B-2.05:** Typical Large Scale HDD Boring Machine (Megadrill Asia)

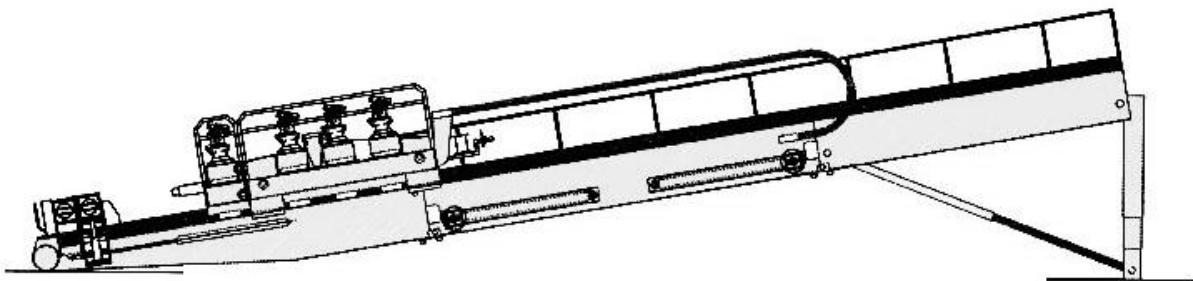

Source: Megadrill Asia

Regardless of the category of directional drilling, the basic process is the same. Although they can be set in a bore pit, the directional drill rig is normally set up on the ground surface. A pilot bore is begun by pushing a drill rod through the ground at a shallow angle (approximately 12 degrees). When the drill head reaches the desired depth, the bore head is steered along a sag shaped curve until it levels out. The pilot bore then continues through the ground at the desired depth and grade until it reaches a receiving pit or the head is once again steered through a sag shaped curve to exit the ground at the surface.



As the name implies, directional drilling is a boring method that can be remotely steered. This is accomplished through the use of a slanted, or anvil shaped device, often called a duckbill. The duckbill attaches to the front of the drill head. The angle of the duckbill causes the drill head to move along a curved path. In order to change the direction of the bore, the drill stem and duckbill are rotated to a position that will cause the bore to move in the desired direction. To bore in a straight line, the drill stem and duckbill are rotated continuously as the bore is advanced. For larger diameter bores, the duckbill may be replaced with a section of slightly bent or curved pipe called a bent sub. This bent sub has the same purpose and effect as the duckbill.

**Figure 14B-2.06: Typical Duckbill**

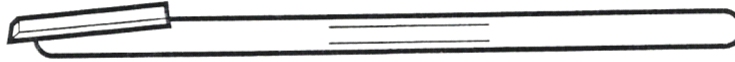

Source: Sterling and Thorne, 1999

In order to steer a bore around obstacles, the operator must know the location of the borehead and the direction it is traveling. This information is provided through the various tracking systems that are available. The most common method is a “walk-over” system. A radio transmitter or “sonde” is located directly behind the bore head and transmits a signal. A receiver, similar to those used by utility companies to detect underground pipes or cables, is used to determine the location and depth of the borehead. The drawback of the walkover system is that it may be difficult to gain access to the area directly above the borehead (i.e. for water crossings, or bores under buildings). There are also “hardwire” tracking systems available. These systems relay information such as head location, depth, and inclination and orientation of the head back to a computer. Based upon this information, the operator can make any necessary adjustments to keep the bore on the desired alignment.

For small diameter bores, the product pipe or cable can often be pulled back through the pilot hole with no additional enlargement of the hole required. However, for larger diameter pipes, it is necessary to increase the diameter of the pilot hole to accommodate the product pipe. This is accomplished by back reaming.

After the pilot bore is completed, the drill head is removed and a back reamer is attached to the drill string. The back reamer serves two functions. The first and most obvious is to enlarge the diameter of the borehole to a size large enough to allow room for the product to be installed. As a rule of thumb, the size of the borehole is normally reamed to a diameter of 1.5 times the diameter of the product to be installed. The second function of the reamer is to mix the soil cuttings with the drilling fluids to create a slurry. The reamer is rotated and pulled back through the pilot hole, thereby cutting the soil and increasing the diameter of the bore. At the same time, drilling fluid is pumped through the drill string to the reamer. The cuttings mix with the drilling fluid, forming a slurry. Some of this slurry is forced out of the borehole, into the receiving pit. However, most of the slurry remains in place to support the borehole, and keep it from collapsing until the product pipe is pulled into place.

Upon completion of the boring and reaming processes, the product assembled into one full length. It is laid out in-line with the bore and pulled into place. As it is pulled into place, the required volume of slurry is forced out of the hole. The remaining slurry between the outside of the pipe and the inside of the reamed borehole remains in place permanently to provide support to the borehole.

- 2. Typical Applications/Materials:** Directional drilling can be used to install a variety of pipelines, including cables, pressurized gas or water lines, sewer force mains, and water services. Steel and HDPE are the most common types of materials installed by directional drilling; however, PVC, copper, and other flexible materials can also be successfully installed.

Although it can be done, directional drilling can be difficult for installing products at small slopes. Therefore, it may not be suitable for installing gravity pipelines.

**3. Range of Applications:**

- a. Pipe Sizes and Bore Lengths:** As mentioned previously, Mini-HDD is for drive lengths of less than 600 feet and pipe sizes up to 10 inches in diameter. HDD can accommodate pipe diameters between 12 and 60 inches and pipe lengths over 2,000 feet.
- b. Soil Conditions:** Directional boring techniques can be utilized under many different soil conditions. Clays, silts, and sands are considered ideal. Directional drilling in gravelly or rocky ground can be done; however, speed and accuracy may be reduced considerably.
- c. Tolerances:** The accuracy for directional drilling varies depending on ground conditions and operator experience. Normally, an accuracy of  $\pm 1\%$  of the length of the bore can be expected for HDD and within 6 to 12 inches for Mini-HDD.

- 4. Relative Cost vs. Other Trenchless Methods:** Installation of small diameter pipe and cable by Mini-HDD techniques is very economical and is, quite often, less expensive than open cut techniques. In fact, Mini-HDD is often preferred over open cut even in wide open areas due to its lower overall cost.

Installation by HDD of large diameter pipelines is a highly specialized operation requiring special equipment. Given this, it is not economically feasible for relatively short bores. However, given sufficient bore length, HDD can become an economical alternative due to the minimal environmental impact speed of installation.

- 5. Potential Problems with HDD:** While HDD is not intended to be a compactive method of installation, a poor choice of drilling fluid or other installation errors can lead to compaction around the installed pipe. This unintended compactive effort can lead to frac out and/or lifting of the soils.

**Figure 14B-2.07:** Pavement Cracking Caused by HDD Installation



Source: Iowa Highway Research Board Project TR-570

Shallow HDD bores under pavements can result in pavement cracking, as seen in the left picture in the above figure. A general rule of thumb is that the depth of the installation should be one foot per inch of pipe being installed.

HDD installations that are not back-reamed to a sufficiently large diameter have been observed to cause heave. When the product pipe is pulled into the hole, some of the drilling fluid is displaced and must flow out of the hole. The drilling fluid is expected to pass in the opposite direction that the pipe is being pulled and therefore must travel through the annular space between the outside of the pipe and the edge of the hole. The rule of thumb for HDD is that the diameter of the hole should be 1.5 times the outside diameter of the pipe. However, sometimes contractors do not include the thickness of the pipe and bells or other protrusions on the outside of the pipe when they calculate pipe diameter. If the machine generates high enough pulling force, drilling fluid pressure can become high enough to heave the soil. An example of soil heaving is seen in the above figure.

## H. Pipe Jacking and Utility Tunneling

1. **Description of Process and Equipment:** The processes of pipe jacking and utility tunneling are two distinctly separate methods, but are both characterized by their necessity for workers to enter the pipe to perform the excavation.
  - a. **Pipe Jacking:** Pipe jacking is a trenchless technique in which a casing pipe is pushed, or jacked, into the ground, while at the same time, soil is excavated by personnel at the front of the bore.

The setup for a pipe jacking operation begins in a manner similar to that for auger boring. Bore pits are excavated at the entrance and exit of the proposed bore. A guide rail, or jacking frame, is placed to support the pipe and the jacking equipment, and a thrust block (normally concrete) is installed.

A jacking shield is pushed into the ground, ahead of the following pipe sections. The purpose of the jacking shield is to provide a safe area for workers to perform the excavation at the face (front) of the bore. This excavation may be done manually or mechanically, as discussed below.

Spoil is normally removed from the bore using small carts which are either battery powered, or pulled in and out with a winch. Alternatively, the spoil may be removed with small augers, or by using a conveyer system.

As excavation takes place, hydraulic jacks at the entrance pit force the pipe through the ground. The pipe is jacked in sections. When one section is completed, the hydraulic jacks are moved back, another section of pipe is set at the entrance pit, and the process is repeated until the bore reaches the reception pit.

Pipe jacking is a very accurate method of boring. A laser back at the bore pit is set to the appropriate line and grade and shot through the pipe to a target at the front of the bore. Workers can view the laser beam to determine what corrections need to be made. All modern equipment incorporates an automatic steering system. The bore is steered by adjusting the jacking forces back at the bore pit or at the face of the bore.

Figure 14B-2.08: Typical Pipe Jacking Installation

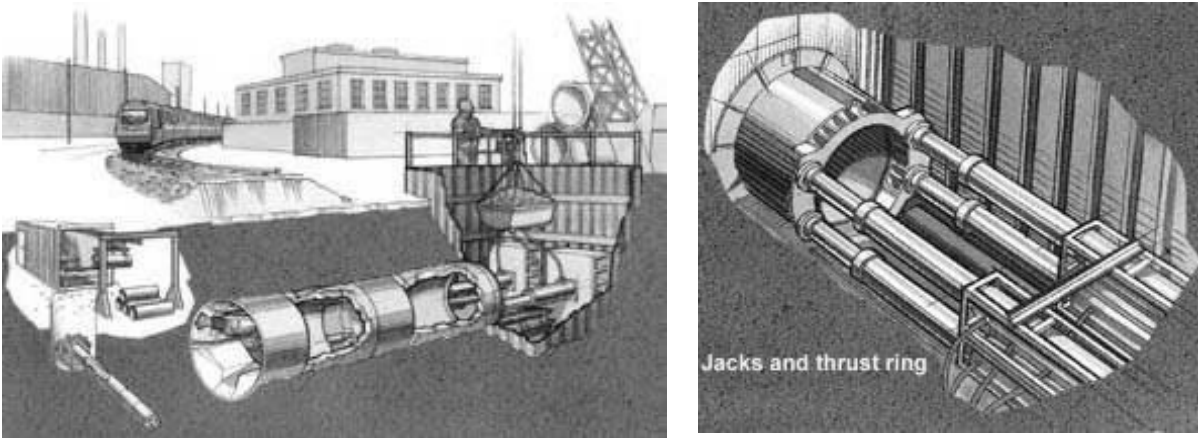

Source: The Pipe Jacking Association

- b. Utility Tunneling:** Like pipe jacking, utility tunneling excavation is done inside of a specially designed tunneling shield. The method is differentiated from pipe jacking by the lining installed, and the method of jacking.

In pipe jacking, pipe forms the lining of the borehole. In utility tunneling, steel liner plates or rib and lagging form the liner. The liner plates are prefabricated modular units utilized to construct a temporary lining. This temporary lining supports the excavation until it is complete. Upon completion, the permanent utility pipe is pushed through the tunnel, and the annular space between the steel lining and the pipe is filled.

Another distinction between utility tunneling and pipe jacking is that this liner is not jacked or pushed into place. It is constructed in-place in the tail section of the shield. Hydraulic jacks or rams are not required in the bore pit. Rather, as the tunnel is extended, hydraulic jacks on the rear section of the tunneling shield thrust against the previously installed liner plates, pushing the shield forward. After the shield has been pushed forward far enough so that one or more courses of liner plates can be placed, the jacking operation ceases and the jacks are retracted so that the liner plates can be installed in the tail section of the shield.

Like pipe jacking, excavation inside of the shield is done by personnel, either manually or mechanically as discussed below. The spoil is removed from the bore with either small carts, augers, or a conveyer system.

Figure 14B-2.09: Typical Utility Tunnel Installation

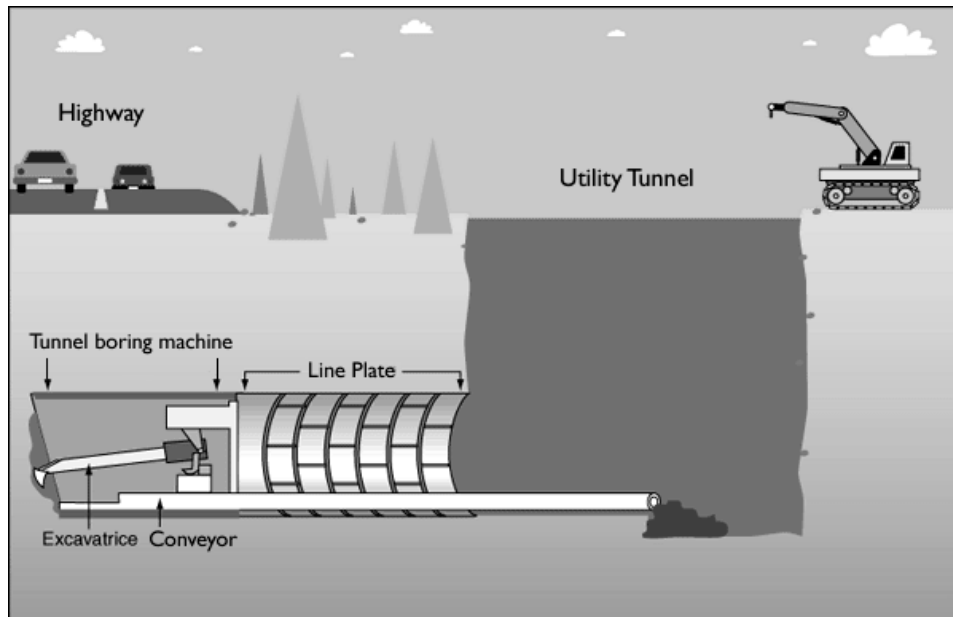

Source: Nella Drilling, Inc.

- c. **Pipe Jacking and Utility Tunneling Excavation Methods:** Several different methods are available for excavating the spoil for a pipe jacking or utility tunneling project. These methods include hand mining, open face shield, tunnel-boring machine, and the road header method.
- 1) **Hand Mining:** Hand mining is the most basic method of excavation. It consists of workers using either pneumatic equipment or simply picks and shovels to excavate the material away from the face of the bore. This method is very slow, but has distinct advantages. Workers can readily address mixed face conditions, boulders, and other large obstacles such as tree stumps. This method is limited to relatively short drives that do not justify the investment in tunneling equipment, or to conditions that demand hand tunneling.
  - 2) **Open Face Shield:** As the name implies, the open face shield method consists of an exposed face at the front of the shield. Excavation is done by a small backhoe or other piece of equipment mounted inside of the shield. Like hand mining, this method allows workers full access to the face of the bore to deal with poor soil conditions or obstacles in the path of the bore.
  - 3) **Road Header Method:** A road header is a wheel or track mounted piece of equipment with a toothed sphere attached to the end of a boom. The ball is rotated and used to excavate soil or rock from the face of the bore. This method is particularly useful in non-circular tunnels.
  - 4) **Tunnel Boring Machines:** Excavation by tunnel boring machine is the most common method of excavation for pipe jacking; however, its use is limited to circular tunnels. A tunnel boring machine is a full face machine, which means that the face of the excavation is fully supported by the cutting head. The cutting head rotates and excavates soil from the face. This soil passes through small openings in the cutting head. An operator sits at the front of the bore, immediately behind the cutting head. From this vantage point, the operator can steer the bore and make any necessary adjustments. Tunnel boring machines are fast and efficient, especially for long bores.

2. **Typical Applications/Materials:** Pipe jacking is used primarily for conduits that must conform to tight tolerances such as culverts and gravity storm and sanitary sewers. Jacking pipe materials must be able to withstand the high compressive forces that are involved in the process. Typical jacking pipe can be steel, reinforced concrete, centrifugally cast glass-fiber-reinforced polymer mortar (CCFRPM - Hobas) pipe, or vitrified clay. In many cases, the jacking pipe also doubles as the carrier pipe. If a separate carrier pipe is installed, it can be almost any pipe material, including plastic or other flexible pipe.

Utility tunneling is also used for installing utility conduits such as storm sewers, sanitary sewers, and culverts. Utility tunneling should be differentiated from the major tunneling installations that are used as passageways for pedestrians or vehicles. As discussed above, utility tunneling involves the installation of prefabricated steel liner plates as a temporary support structure. The final carrier pipe needs to be of sufficient strength to withstand the forces imparted during the grouting of the annular space, and any potential earth loads transferred to the carrier pipe.

3. **Range of Applications:**

- a. **Pipe Sizes and Bore Lengths:** Since both pipe jacking and utility tunneling require workers to enter the excavation, these methods are typically limited to pipe sizes 42 inches and greater. For extremely long installations, the minimum recommended size is 48 inches.

Theoretically, the length of pipe jacking and utility tunneling installations is unlimited. Since the liner pipe is not pushed through the ground for utility tunneling, forces do not increase as the length of the tunnel increases. Pipe jacking lengths can be increased through the use of intermediate jacking stations. The intermediate jacking stations may be installed at intervals along the pipe, and allow the pipe to be jacked in sections, rather than all at once.

- b. **Soil Conditions:** While stable consistent granular and cohesive soils are the most favorable for these methods, pipe jacking and utility tunneling can be utilized in almost all soil conditions with the appropriate equipment and precautions.
- c. **Tolerances:** Pipe jacking and utility tunneling are highly accurate, steerable methods. Installations within 1 inch of proposed line and grade are possible.

4. **Relative Cost vs. Other Trenchless Methods:** Pipe jacking and utility tunneling are specialized operations that require a significant investment in equipment. Typically, these methods are significantly more expensive than auger boring or other trenchless methods (except microtunneling) due to the equipment investment required.

## I. Microtunneling

1. **Description of Process and Equipment:** The microtunneling process is essentially remote controlled pipe jacking. All operations are controlled remotely from the surface, eliminating the necessity for personnel to enter the bore.

The excavation is made with a remotely controlled tunnel boring machine. Like pipe jacking, the tunnel boring machine is laser guided and can be steered to maintain the required grade and alignment.

The spoil generated can be removed by either mixing the soil with water into a slurry and pumping it out of the bore or by removing the spoil with an auger inside a separate auger casing inside the jacking pipe.

**2. Typical Applications/Materials:** Like pipe jacking, microtunneling is normally utilized for constructing pipelines requiring a high degree of accuracy, such as gravity storm sewers and gravity sanitary sewers. Similar to pipe jacking, the casing pipe must be able to withstand the high jacking forces required to push the pipeline through the ground. Common pipe materials installed with microtunneling include steel, ductile iron, reinforced concrete pipe, centrifugally cast fiberglass-reinforced polymer mortar (CCFRPM) pipe, and vitrified clay pipe.

**3. Range of Applications:**

**a. Pipe Sizes and Bore Lengths:** The term “microtunneling” can be deceiving. Microtunneling was originally developed as a pipe-jacking technique for pipe diameters too small to allow man entry. Since that time, the sizes of pipes installed by microtunneling have continued to increase due to the benefits and added safety provided by eliminating the requirement for personnel to enter the bore. Now, almost any diameter of pipe can be installed by the microtunneling technique from 10 inches to 120 inches. For example, the Chunnel, with a diameter of 25 feet, was constructed using microtunneling techniques.

One limitation of microtunneling is that since the excavation must be done with a tunnel boring machine, only circular pipes can be installed.

**b. Soil Conditions:** Microtunneling can accommodate a wide variety of soil conditions. Boulders or rocks up 20% to 30% of the diameter of the pipe can normally be removed.

**c. Tolerances:** Like pipe jacking, microtunneling is a laser-guided method, which is steerable and highly accurate. Installations within 1 inch of proposed line and grade are possible.

**4. Relative Cost vs. Other Trenchless Methods:** Microtunneling equipment is highly specialized and costly. However, due to the advantages and speed that the method provides, unit prices on large projects can be in line with other trenchless methods. For relatively short bores, microtunneling tends to be costly.

Table 14B-2.01: Summary of Various Trenchless Techniques for New Construction

Method	Diameter Range (inches)	Maximum Installation Length (feet)	Pipe Material	Working Space Requirements	Typical Application	Accuracy / Tolerances
Auger Boring Steered Auger Boring	4 to 60	600	Steel	Entry and Exit pits: 26 to 36 feet long	Road and Railroad Crossing Pressure and Gravity Pipe	± 1% of Bore Length ± 12 inches
Compaction Methods	Less than 12	200	Any	Large area required to accommodate bore pit and to lay out pipe	Pressure Pipe/Cable	± 1% of Bore Length
Pipe Ramming	2 to 55	200	Steel		Road and Railroad Crossing	Not Accurate
<u>Slurry Methods:</u> Water Jetting Slurry Boring	Less than 4 Varies	30 Varies	Any	Minimal	Pressure Pipe/Cable	Not Accurate
<u>Directional Methods:</u> Mini-HDD HDD	2 to 12 12 to 60	600 Greater than 2,000	PE, Steel, PVC PE, Steel	Boring pits not generally required. For HDD, need space to set up rig: up to 400 feet long	Pressure Pipe/Cable Pressure Pipe	Varies
Microtunneling	8 and Greater	750	RCP, GPMP, VCP, DIP, Steel, PVC, PCP	Jacking Pit: 20 feet long Requires smaller retrieval pit	Gravity Pipe	± 1 inch
Pipe Jacking	42 and Greater	1,600	RCP, GPMP, Steel	Jacking Pit: 10 to 30 feet long	Pressure and Gravity Pipe	± 1 inch
Utility Tunneling	42 and Greater	Unlimited	RCP, GPMP, Steel	Launch Pit: 10 to 30 feet long	Pressure and Gravity Pipe	± 1 inch

Abbreviations:

DIP - Ductile Iron Pipe

PE - Polyethylene

VCP - Vitrified Clay Pipe

GRP - Glass-Fiber Reinforced Polyester

PVC - Poly-Vinyl Chloride

GPMP - Glass-Fiber Polymer Mortar Pipe

RCP - Reinforced Concrete Pipe

Source: Trenchless Construction Methods and Soil Compatibility Manual, 1999