



Table of Contents

Chapter 9 - Utilities

9A General Information

9A-1-----General Information

- A. General..... 1
- B. Definitions..... 1
- C. Design..... 2

9B Trench Design

9B-1-----General Information for Trench Design

- A. Trench Theory..... 1
- B. Bedding and Foundation Materials..... 1
- C. Backfill Materials..... 2
- D. Dewatering..... 3

9B-2-----Rigid Pipes

- A. Introduction..... 1
- B. Trench Width..... 1
- C. Pipe Strength..... 2
- D. Bedding Factors..... 3
- E. Live Load..... 3

9B-3-----Flexible Pipes

- A. Introduction..... 1
- B. Soil-pipe Interaction..... 1
- C. Pipe Design..... 2
- D. Flexible Pipe Bedding..... 4
- E. Trench Width..... 5
- F. Pressure Pipe..... 5

9B-4-----Ductile Iron Pipe

- A. Introduction..... 1
- B. Pipe Design..... 1
- C. Bedding..... 1

9B-5-----Depth of Bury Tables

- A. General..... 1
- B. Rigid Pipe Assumptions..... 1
- C. Flexible Pipe Assumptions..... 4
- D. Ductile Iron Pipe Assumptions..... 7

9C Casing Pipe

9C-1-----Casing Pipe

- A. General..... 1
- B. Casing Thickness..... 1
- C. Casing Diameter..... 2

9D Utility Cut Restoration

9D-1-----Utility Cut Restoration

- A. General..... 1
- B. Background..... 1
- C. Factors Affecting Patch Performance..... 2
- D. Recommended Utility Trench..... 8

9E References

9E-1-----References

General Information

A. General

Proper regulation of the location design and methods for installation, maintenance, and adjustment of private and public utilities in the roadway right-of-way is necessary for safety, public service, and orderly development. Utility lines should be located to minimize need for later adjustment, to accommodate future roadway improvements, and to allow servicing such lines with minimum interference to traffic and interruption of other utility services.

Longitudinal installations should be located on uniform alignment to provide a safe environment for traffic operation and preserve space for future roadway improvements or other utility installations. Whenever feasible and practical, utility line crossings of the roadway should intersect on a line perpendicular to the roadway alignment. Consideration should be given to encasing or installing utility line crossings in tunnels or conduits to allow servicing without disrupting the traffic flow.

When street grades, alignments, or widths are changed, utilities are usually required to relocate. Often, standard locations are inapplicable and unobtainable in street areas where existing utilities are seriously crowded and where it would not be feasible to expect significant reorientation. The location criteria must be practical and applicable in new developments, in urban relocation work, and in cases where overhead facilities are being converted into underground structures and plans. Utilities are not expected to change existing facilities as to location or depth simply for the purpose of creating uniformity. However, when new or relocation work is undertaken, uniformity should be sought wherever possible.

The horizontal and vertical location of utility lines within the roadway right-of-way limits should conform to the clear zone policies applicable for the system, type of roadway, and specific conditions for the particular section involved.

B. Definitions

Right-of-way: The land area of which the right to possession is secured or reserved by the Jurisdiction for the project, including permanent roadway easements.

Roadway: The portion of the right-of-way designated or ordinarily used for vehicular travel.

Sidewalk: That portion of the street primarily constructed for the use of pedestrians.

Street (Road): A general term denoting public way for vehicular travel, including the entire area within the right-of-way.

Utility: Includes all privately, publicly, municipally, or co-operatively owned structures and systems for supplying water, sewer, electric lights, street lights and traffic lights, gas, power, telegraph, telephone, communications, transit, pipelines, and the like.

C. Design

1. Limited right-of-way widths:
 - a. Because of lack of space for utilities in most metropolitan areas, special consideration should be given in the initial roadway design to the potential for joint usage of the right-of-way that would be consistent with the primary function of the roadway.
 - b. When the sanitary sewer is located outside of the paved surface, the gas, electric, telephone, and/or cable TV may need to be located in special utility easements in the front and/or rear yard.
 - c. Existing development and limited right-of-way widths may preclude location of the sanitary sewer outside the paved surface of the roadway. Some cities may allow sanitary sewer within the roadway. Location under the paved surface requires special consideration and treatment. Accommodation of these facilities under the paved surface should be accomplished in a manner that will ensure a minimum adverse effect on traffic as a result of future utility service and maintenance activities.
2. Utility poles, vent standpipes, and other above-ground utility appurtenances that would constitute hazards to errant vehicles should not be allowed within the roadway clear zone. The only exceptions allowed would be where the appurtenance is breakaway or could be installed behind a traffic barrier erected to protect errant vehicles from some other hazard. The clear zone dimension to be maintained for a specific roadway use will be found in [Chapter 5, Roadway Design](#).
3. Attachments of utility lines to bridge structures should be avoided where possible. Where there are no feasible alternate locations, such installations on bridge structures should be concealed from view. When attachments to bridges or structures are approved, the Engineer should refer to specific Jurisdiction standards for price of attachment, method of attachment, and other requirements.
4. On new installations or adjustment to existing utility lines, provision should be made for known or planned expansion of the utility facilities, particularly those located underground or attached to bridges. It is important that the placement of the utility considers the future widening of the roadway.
5. All utilities located within the public right-of-way for new roadway construction should comply with the drawing based on the width of right-of-way and pavement width.
6. The order of elevation priority for underground installation should be as follows:
 - a. Sanitary sewer
 - b. Storm sewer
 - c. Water main
 - d. Other utilities

Figure 9A-1.01: Typical Urban Utility Locations

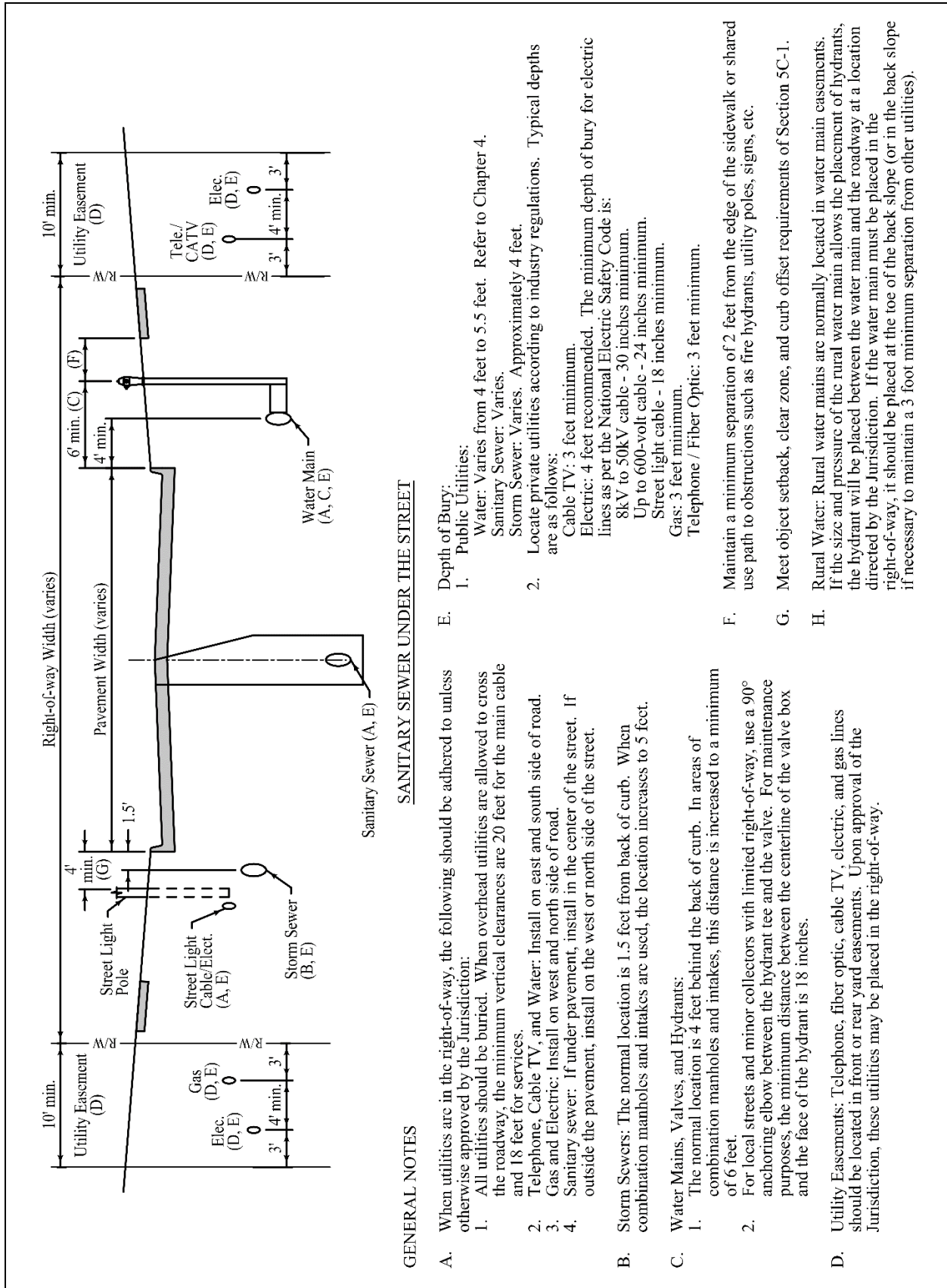
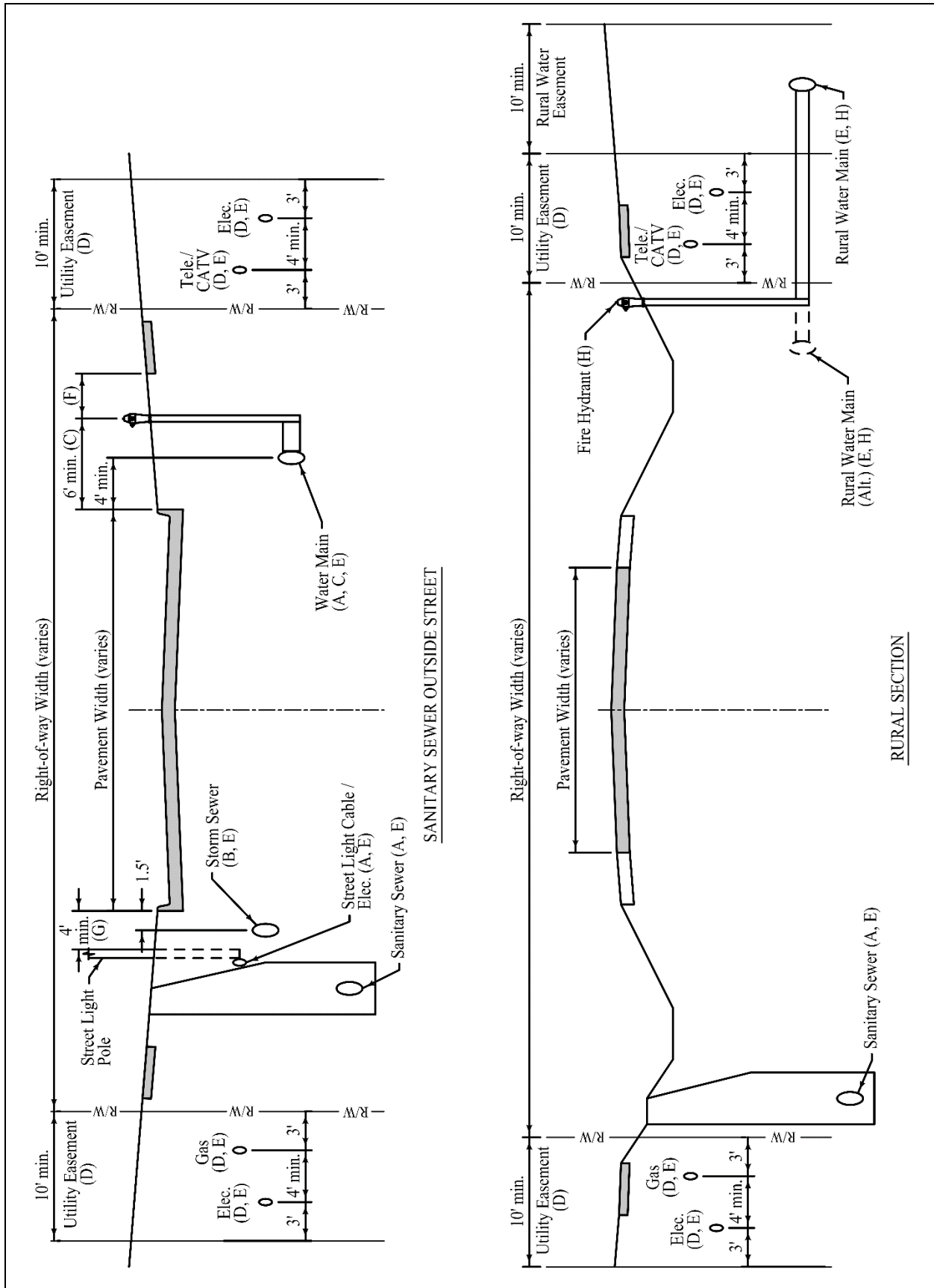

Figure 9A-1.01 (Continued): Typical Urban Utility Locations



General Information for Trench Design

A. Trench Theory

When designing a pipe, the first step is to determine the flow capacity required, which will then determine the pipe type, diameter, and grade. The capacity of the pipe must be sufficient to carry external loads once it is buried.

A buried pipe must resist the dead load of the soil above it and any live loads applied at the surface, or the pipe will fail. Because buried pipes interact with the surrounding soil based, in part, on the stiffness of the pipe, different design methodologies have been developed for determining loads on rigid and flexible pipes.

A rigid pipe has significant strength but will crack if it is deformed. Because of this, a rigid pipe relies on its strength to carry external loads when buried. However, because of its stiffness, a rigid pipe must carry the entire load of the soil above it, and even some of the load from the soil adjacent to it. Rigid pipe design methodology is described in more detail in [Section 9B-2 - Rigid Pipes](#).

A flexible pipe does not have the strength of a rigid pipe, but it will not crack when deformed. Because of this, a flexible pipe relies on its ability to deform to reduce the load on the pipe by transferring most of the load to the surrounding soil. Flexible pipe design methodology is described in more detail in [Section 9B-3 - Flexible Plastic Pipes](#).

When analyzing a proposed pipe installation, both the magnitude of the load imposed on the pipe and the capacity of the pipe to carry the load must be determined. Both of these values are influenced by a number of factors, including the pipe's flexibility or rigidity, the pipe bedding, soil properties, and installation practices. Because these factors all interact with each other, it is important to understand how each one affects the ultimate performance of the pipe. These properties are described in more detail below and in the following sections.

B. Bedding and Foundation Materials

- 1. Granular Bedding Material:** Bedding is the material installed in the bottom of the trench on which the pipe is laid. Proper pipe bedding is critical to the load carrying capacity of both rigid and flexible pipes. Clean, crushed Class I granular bedding material should be used for all gravity sewer installations. Granular bedding material is commonly used as backfill in the haunch zone (below the springline) as well as for primary and secondary backfill zones, depending on the pipe material.

Although the interaction between the soil and pipe is different for rigid and flexible pipes, both types require proper placement and compaction of the bedding material under the pipe and in the haunch zone for proper support. By supporting rigid pipes along the bottom of the pipe, the pipe load is distributed over a larger area, thereby reducing the concentrated stresses at the invert of the pipe. Flexible pipes require proper bedding and haunch backfill to provide sidewall support for the pipe. As a flexible pipe deflects vertically, the sides of the pipe move outward. Without proper sidewall support and resistance to these lateral deflections, the vertical pipe deflections can exceed allowable levels.

Because bedding and haunch support is critical to the performance of both rigid and flexible pipes, proper installation of materials in these areas is critical. Most pipe installation guides recommend hand placement and slicing of granular bedding material with a shovel to ensure there are no voids in the haunch zone. Soil backfill should be compacted with hand compaction equipment in the haunch zone after placement of the pipe. Due to a variety of factors, including time constraints, lack of inspection, and concerns over trench safety, hand working and compacting backfill around a pipe are almost non-existent in today's construction industry.

In order to address these issues, the use of clean, self-compacting granular bedding and backfill material is recommended. Properly graded, clean, crushed stone that is dumped into a trench and shaped requires little or no additional compaction effort to provide a moderate degree of compaction. In addition, this material will bridge over some soft or yielding soils, reducing the need for over-excavation and foundation material. SUDAS Class I Material is a 1 inch, clean, crushed stone that should be used for most pipe bedding applications.

Where Class I or similar material is not available, gravel or crushed concrete may be used. However, these materials do not possess the self-compacting quality that Class I material has. Additional time and effort will be required to place and compact these materials. Increased construction observation may be required to ensure that the materials are properly placed and compacted.

- 2. Stabilization (Foundation) Material:** The bottom of the trench should be firm, stable, and uniform to support the pipe and prevent movement during backfill and compaction. When Class I bedding material is inadequate for bridging trench bottoms with soft or yielding soils, overexcavation of the trench bottom and installation of stabilization material should be considered.

Stabilization material consists of 2 1/2 inch clean crushed stone. It is installed in the bottom of the trench after overexcavation to remove any soft or yielding soils. The required depth of overexcavation and stabilization material varies as required to provide a firm base. Class I granular bedding and normal backfill are placed on top of the stabilization material as in a normal installation.

Stabilization material can also be substituted for Class I bedding material when installing heavy pipe, such as concrete pipe 48 inches and greater. For heavy pipe, Class I bedding may be susceptible to movement under the weight of the pipe. Since stabilization material is significantly larger, it is better able to resist movement under heavy loads.

C. Backfill Materials

- 1. Haunch Support:** The haunch support zone extends from the top of the bedding material to the springline, or mid-point, of the pipe. Like pipe bedding, this zone is critical to the support and performance of the pipe. For flexible pipes, this zone should be backfilled with Class I granular bedding material in order to provide adequate sidewall support to the pipe. Rigid pipes may be backfilled with Class I bedding material or suitable native soil, depending on the depth of the installation. Because a portion of the haunch zone is located underneath the pipe, this area is difficult to compact. If Class I granular bedding material is not used to backfill the haunch support zone, careful attention must be paid to ensure that proper compaction is achieved in this area and that the pipe is not damaged by compaction equipment.

2. **Primary and Secondary Backfill:** The primary backfill zone extends from the springline of the pipe to the top of the pipe. The secondary backfill zone extends from the top of the pipe to 1 foot over the top of the pipe. For most plastic pipes, the Class I granular bedding material should be extended from the haunch through the primary and secondary backfill zones. While these areas can be more easily compacted than the haunch area, plastic pipes are susceptible to damage by compaction equipment. Therefore, this zone is typically backfilled with Class I bedding material in order to protect the pipe from damage during compaction.

Though care must still be taken during compaction, rigid and ductile iron pipes may be backfilled with suitable native materials.

3. **Final Backfill:** The final backfill zone extends from the top of the secondary backfill (1-foot above the top of the pipe) to the top of the trench. The materials placed in the final backfill zone have little impact on the load carrying capacity of the pipe. However, it is important that this area be backfilled with suitable soils and properly compacted to avoid future settlement. This is particularly important when the trench is located under future paving.

D. Dewatering

All pipes should be installed in a trench with a dry bottom. Ideally, the water table should be at least 2 feet below the bottom of the excavation. For installations below the water table in soils with a high coefficient of permeability, dewatering may be required. Due to the slow flow of water, installations in clay soils do not generally require dewatering, and water in the trench can be controlled with sump pumps. A number of methods are available when dewatering is required.

Well points (often called sand points) are one of the most common methods of dewatering. The well point system consists of a number of small diameter wells installed at regular intervals (typically 3 to 8 feet) adjacent to the proposed trench. Each well contains a pipe that extends down to the bottom of the well. At the surface, the end of each pipe is connected to a header pipe, which is connected to a vacuum pump. The use of well points results in a localized drawdown of the water table. Because groundwater is extracted by vacuum, the maximum depth of dewatering by well points is limited to 15 to 20 feet.

For installations where the trench bottom exceeds the limits of the well point system, or where the well points interfere with the construction, a deep well system may be required. A deep well system consists of a single well or a much smaller number of wells than a well point system. Wells may be spaced at 50 foot intervals or larger. In a deep well system, each well has a pump located at the bottom of the casing. This eliminates the depth limitations of the well point system. Deep wells can be installed to depths of up to 100 feet with a single-stage pump. Deep wells can draw down the water table over a significantly larger area than a well point. For this reason, they should be used with caution in areas where existing structures are present, as the reduction in water table level can cause settlement.

Rigid Pipes

A. Introduction

Rigid pipes are generally considered pipes that cannot deflect 2% of their diameter before failing. Common rigid pipes include concrete and clay as well as other specialized pipe materials. Because rigid pipes do not deflect significantly when loaded, the pipe itself must be capable of supporting the backfill placed over it and any additional loads that are applied to it.

A number of factors, including trench width, pipe strength, and bedding type, affect the magnitude of the load transmitted to the pipe and the ability of the pipe to carry the load. In an urban setting, most public utilities, including storm sewer, sanitary sewer, culverts, or water mains, are installed in an open trench; therefore, it is important to understand each of these characteristics and how they affect the structural capacity of a rigid pipe.

B. Trench Width

After trench excavation and pipe installation, bedding and backfill materials are placed in the trench. Even with proper compaction, the bedding and backfill materials in the trench will continue to undergo settlement. Because the height of the soil columns between the pipe and the trench walls are greater than the height of the soil column immediately above the pipe, and because a rigid pipe does not deflect, the areas adjacent to the pipe will undergo greater settlement than the soil column directly over the pipe.

As differential settlement occurs between the soil columns adjacent to the pipe and the columns directly above it, frictional forces are generated along the trench walls and along the central soil column over the pipe. As the adjacent soil columns settle, they drag the central soil column down, transferring a portion of their load to the pipe. Consequently, a rigid pipe tends to carry the entire load of the soil column directly above it and a portion of the load from the soil columns adjacent to it. The magnitude of the load from the adjacent soil columns that is transferred to the pipe varies, depending on trench width (see Figure 9B-2.01).

As the trench width increases, the load on the pipe will continue to increase until reaching a limiting value called the transition width. At this point, any additional increase in trench width does not affect the load on the pipe, and the pipe behaves as if it were buried in an embankment.

It should be noted that it is the width of the trench at the top of the pipe that affects the load on the pipe. The width or shape of the trench walls above this level can be sloped or stepped without increasing the load on the pipe.

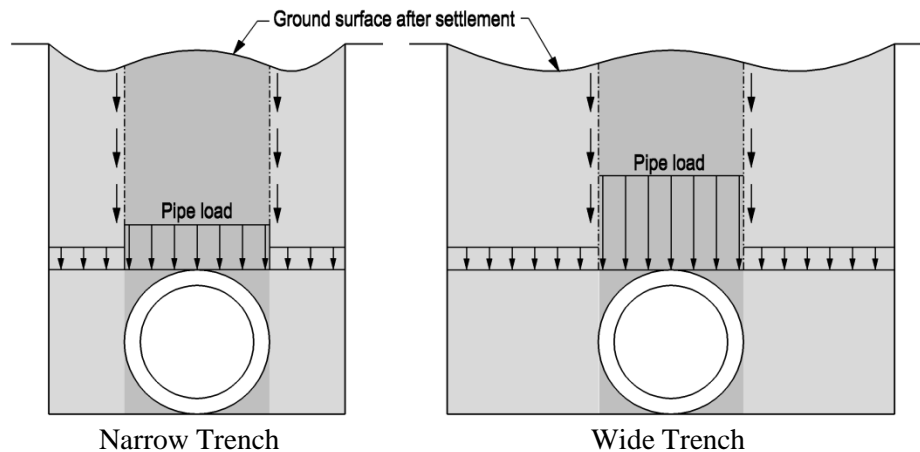
Figure 9B-2.01: Effect of Trench Width on Rigid Pipe Load

In 1913, Anson Marston published a report on the interaction between the pipe and the surrounding soil after studying the problem at Iowa State College. The resulting “Marston Equation” has been used extensively to determine the earth load on pipes. For additional information on the Marston Equation, transition width, and the method of determining actual backfill loads, refer to the “Marston/Spangler Design Procedure” in the American Concrete Pipe Association’s (ACPA) *Concrete Pipe Design Manual*.

C. Pipe Strength

A three-edged bearing test is used to determine the strength of a rigid pipe. The pipe is supported at two locations along the bottom, and a vertical load is applied at the top until the pipe fails. For concrete pipe, two failure methods are defined. The first, $D_{0.01}$, is the load at which a 0.01 inch crack develops in the pipe. The second, D_{ult} , is the ultimate load that the pipe can carry. D-load strengths are measured in pounds per liner foot per foot of pipe diameter. For design purposes, the $D_{0.01}$ value is used to provide a factor of safety. The following table correlates the pipe class with the two D-load values.

Table 9B-2.01: RCP Load Equivalents

Pipe Class ¹ (ASTM C76)	$D_{0.01}$ (lb/ft/ft diameter)	D_{ult} ² (lb/ft/ft diameter)
Class II	1,000	1,500
Class III	1,350	2,000
Class IV	2,000	3,000
Class V	3,000	3,750

¹ SUDAS specifies concrete pipe according to pipe class (minimum Class III)

² Iowa DOT specifies pipe by the ultimate load (e.g. Class III RCP is specified as 2000D)

Clay pipes are also tested, using a three-edged bearing test. The specified strength of clay pipe does not follow the D-load concept and varies depending on pipe diameter. Clay pipe strengths are the ultimate strength of the pipe and vary from 2,000 to 8,000 pounds per foot.

D. Bedding Factors

The forces imparted on a pipe in an installed condition are considerably different than the concentrated forces generated in the lab during a three-edged bearing test. In the installed condition, the pipe is supported and the load is distributed over the entire width of the pipe. Depending on the type of bedding provided, this can significantly increase the load carrying capacity of the pipe.

In order to relate the strength of the pipe from the three-edged bearing test to the actual capacity of the pipe in an installed condition, bedding factors have been developed to address a number of standard bedding types. The SUDAS Specifications closely follow the standard bedding types and the bedding factor values described in the *ACPA Concrete Pipe Design Manual*. For a given pipe strength, the $D_{0.01}$ strength is multiplied by the bedding factor to represent the strength of the pipe in the installed condition (see Figure 9B-2.02).

E. Live Load

In addition to the backfill load, a buried pipe must also support any live loads applied at the surface. For pipes installed under asphalt or concrete pavements, the live load from vehicular traffic is distributed sufficiently by the pavement that the live load transmitted to the pipe is negligible. Likewise, for pipes that are buried deeper than 6 feet, live load can usually be neglected. However, for shallow pipes in unpaved areas, or for pipes that cross under railroads, live loads on the pipe should be considered.

Figure 9B-2.02: Rigid Pipe Bedding Types and Bedding Factors

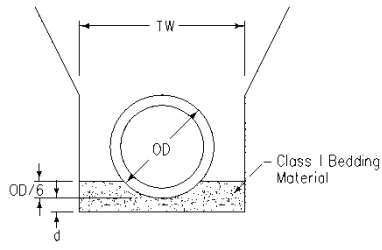

Class R-1
Bedding Factor = 1.5

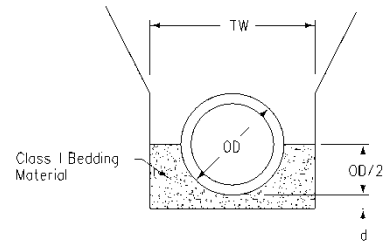

Class R-2
Bedding Factor = 1.9

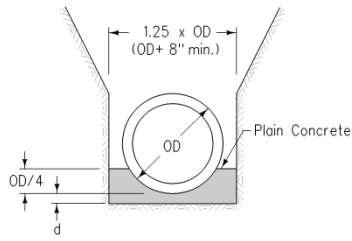

Class R-3 (Unreinforced)
Bedding Factor = 2.8

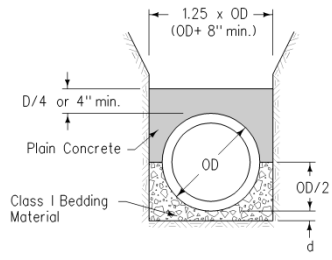

Class R-4 (Unreinforced)
Bedding Factor = 2.8

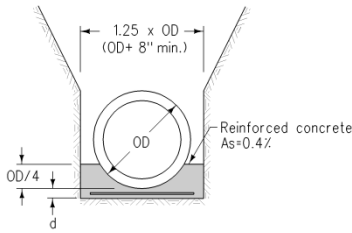

Class R-3 (0.4% Reinforcing)
Bedding Factor = 3.4

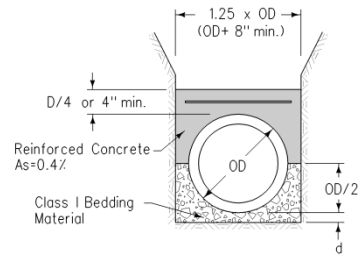

Class R-4 (0.4% Reinforcing)
Bedding Factor = 3.4

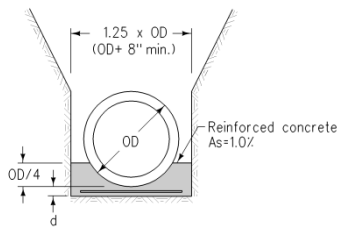

Class R-3 (1.0% Reinforcing)
Bedding Factor = 4.5

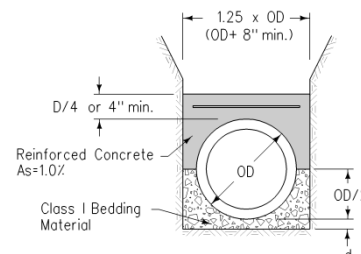

Class R-4 (1.0% Reinforcing)
Bedding Factor = 4.5

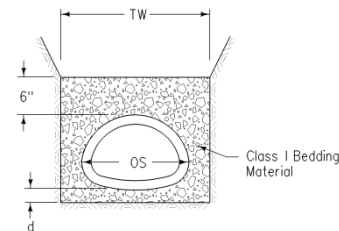

SUDAS Class R-5
Bedding Factor = 1.9

Figure Legend

- d = Bedding depth below pipe; OD/8 or 4" min.
- D = Pipe diameter
- OD = Outside pipe diameter
- TW = Trench width

Flexible Pipes

A. Introduction

Flexible pipes are generally considered pipes that will deflect at least 2% of their diameter without any damage. However, most flexible pipes used for utility applications are required to undergo deflections of 20 to 30% during testing and certification without failing. The key to the performance of a flexible pipe is its ability to deflect without buckling or cracking.

The most common flexible pipes currently in use are polyvinyl chloride (PVC), high density polyethylene (HDPE), and polypropylene. Numerous varieties of each are produced. PVC pipe is used extensively for sanitary sewers and water mains. HDPE pipe is commonly used for subdrains and is also available for storm sewer applications. Polypropylene pipe is used for both sanitary and storm sewer applications.

In order to take advantage of the benefits and avoid the limitations of flexible pipes, it is necessary to understand how they perform and how their properties are defined.

B. Soil-pipe Interaction

A flexible pipe obtains its load-carrying ability from its flexibility. Just like a rigid pipe, after the installation of a flexible pipe, the trench bedding and backfill materials will settle. However, because the flexible pipe deflects when loaded, the central soil column, directly over the pipe, will settle more than the adjacent soil columns.

As differential settlement occurs between the soil column over the pipe and the soil columns adjacent to the pipe, frictional forces between the soil columns transfer some of the load from the central soil column to the adjacent soil columns (see Figure 9B-3.01). This reduces the load on the flexible pipe. As the pipe is loaded, the pipe deflects vertically, pushing the sides of the pipe outward toward the sides of the trench. This results in the development of sidewall support from the pipe bedding.

Figure 9B-3.01: Soil-pipe Interaction for Flexible Pipes

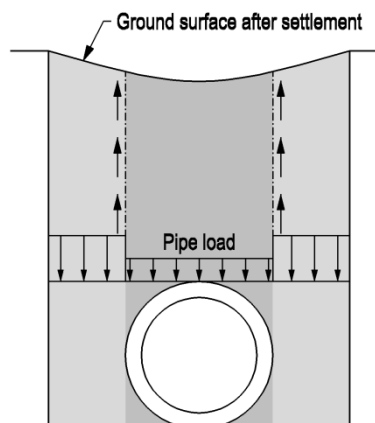

Flexible pipe performance is highly dependent on proper bedding to provide the required sidewall support. A pipe with lateral sidewall support is capable of carrying a significantly larger load than an unsupported pipe. Without sidewall support, some flexible pipes would be crushed by the weight of the backfill above. For this reason, it is imperative that flexible pipes be properly backfilled with high-quality materials.

Given the significance of sidewall support, consideration must be given to the locations where flexible pipes are installed. Flexible pipes should not be used in areas where future adjacent excavations are likely. These excavations could expose or weaken the bedding envelope supporting the pipe.

For additional information on the soil-pipe interaction of flexible pipes, and the method to determine pipe load and predicted deflection, refer to the Uni-Bell PVC Pipe Association's: *Handbook of PVC Pipe: Design and Construction* or the Plastic Pipe Institute's publication: *The Complete Corrugated Polyethylene Pipe Design Manual and Installation Guide*.

C. Pipe Design

The design of most flexible pipes is based upon pipe stiffness. Pipe stiffness is a term used to describe the resistance of a flexible pipe to deflection when subjected to a load. Pipe stiffness is measured by placing a section of flexible pipe between two flat plates. A load is applied until the pipe is deflected 5% of its diameter. The load at which this occurs is the pipe stiffness. Pipe stiffness is specified in lb/in².

In general, pipe stiffness is related to the material properties and wall thickness of the pipe (see Figure 9B-3.02). For solid walled pipe with a given modulus of elasticity, the ratio of the pipe diameter to its wall thickness (diameter ratio or DR) determines the stiffness of the pipe. Solid walled pipes of different diameters, but with the same DR, all have the same pipe stiffness. To provide a stiffer pipe, the wall thickness is increased (i.e., DR is reduced).

Another way to increase pipe stiffness is to change the shape of the pipe wall. Pipe manufacturers have developed a number of different wall cross-sections that increase or maintain pipe stiffness while using less material per foot of pipe. Closed profile pipe uses an "I"-beam-type cross-section. Composite pipe is a dual-walled pipe with a truss-type structure in the middle and the area filled with lightweight concrete. Flexible pipe is also commonly produced with a corrugated exterior and smooth interior.

Regardless of the wall shape, the generally accepted standard for minimum pipe stiffness is 46 lb/in². This corresponds to a PVC pipe with a DR of 35. Pipes with a lower stiffness are also available; however, they should be used with caution in the right-of-way or other areas subject to disturbance for the reasons described in the [Section 9B-2 - Rigid Pipes](#). In addition, installing pipes with stiffness lower than 46 lb/in² should be done under careful supervision to ensure that the pipe has proper bedding. After installation, these pipes should be tested with a mandrel to ensure deflections do not exceed 5%.

Figure 9B-3.02: Types of Commonly Used Flexible Pipe

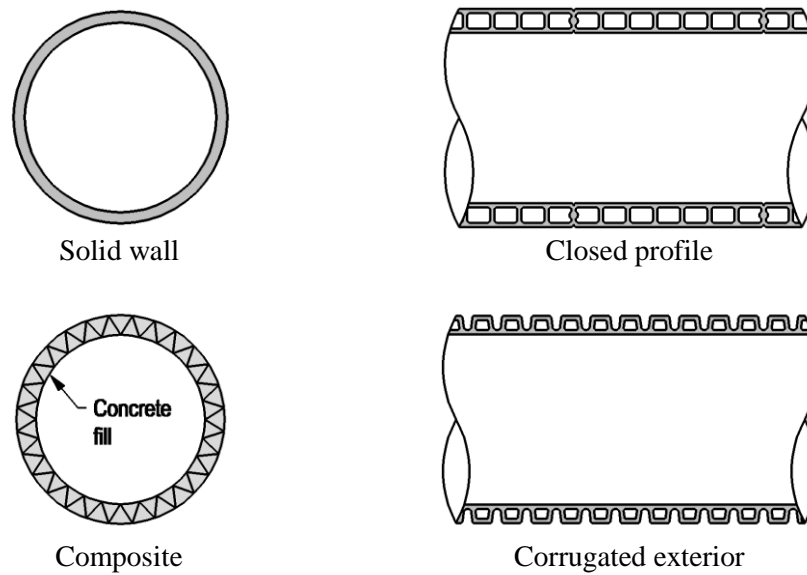

1. **PVC:** PVC pipe is used primarily for sanitary sewer mains and service lines. Sanitary sewer installations are generally deep enough that it is unlikely an adjacent excavation will encroach on the pipe bedding envelope. Therefore, the use of PVC for sanitary sewers in the right-of-way is acceptable. However, for shallow installations, consideration should be given to the possibility of adjacent excavations causing damage. If this is likely, an alternate pipe material or a PVC pipe with higher pipe stiffness should be considered. Use of PVC pipe for storm sewer applications requires specific approval by the Engineer due to the increased potential for impact to the pipe envelope and subsequent damage to the pipe from adjacent or crossing excavation activity.

For a given class of PVC pipe, pipe stiffness is generally consistent regardless of the diameter. The minimum PVC pipe stiffness allowed in the SUDAS Specifications is 46 lb/in².

2. **HDPE:** HDPE pipe has been used extensively as subdrain and as agricultural drain tile. HDPE storm sewer pipe is also available. Unlike PVC pipe, the pipe stiffness for HDPE pipe varies depending on diameter. Use of HDPE pipe for storm sewer applications requires specific approval by the Engineer due to the increased potential for impact to the pipe envelope and subsequent damage to the pipe from adjacent or crossing excavation activity.

In addition to pipe deflection, HDPE pipe must also be analyzed for several additional failure modes. These include wall thrust, buckling pressure, bending stress, and bending strain. In general, the limits on the depth of bury for HDPE pipe is not due to deflection, but wall thrust.

One of HDPE pipe's material properties is its tendency to creep, or permanently deform when stressed beyond a certain level for an extended time. If the wall thrust stresses at the springline of the pipe are high enough, the sidewall of the pipe can undergo permanent deformation. Wall thrust failures occur as rippling, buckling, or cracking at the springline of the pipe.

3. **Polypropylene:** Polypropylene pipe can be used for both sanitary sewer and storm sewer applications. It is made from polypropylene resin to form a pipe that has improved impact resistance and less susceptibility to brittleness than HDPE pipe.

The minimum pipe stiffness allowed in the SUDAS Specifications is 46 psi. The smaller pipe diameters (12 inch to 30 inch) are double walled with a smooth interior and corrugated exterior.

In order to maintain the minimum pipe stiffness in the larger diameters (30 inch to 60 inch), the pipe is triple walled. Both the double wall and triple wall pipe have an integral bell and spigot joint.

Use of polypropylene pipe for storm sewer applications requires specific approval by the Engineer due to the increased potential for impact to the pipe envelope and subsequent damage to the pipe from adjacent or crossing excavation activity.

D. Flexible Pipe Bedding

For most gravity installations with flexible pipe, granular bedding material is recommended. Suitable granular bedding material is self-compacting when placed in the trench. This ensures proper pipe support is provided in the area below the springline, where it is difficult to provide mechanical compaction. The bedding below the springline is critical for providing proper sidewall support for flexible pipes.

Granular bedding should be extended to the top of the pipe for storm sewers (Bedding Class F-2), and to 1 foot over the top of the pipe for sanitary sewer installations (Bedding Class F-3). The additional granular bedding material in this area protects the pipe from impact and movement during final trench backfill. In excavations where trench boxes are used, care must be taken to prevent disturbance of the pipe and bedding material when moving the trench box.

For gravity pipe installations using ductile iron pipe or other flexible water main materials, granular bedding material may not be required along the sides of the pipe, due to the additional pipe strength provided by these products. For these applications, granular bedding is only required under the pipe (Bedding Class F-1) to assist in achieving the proper grade and alignment.

Figure 3 illustrates the standard bedding classes for flexible pipe installations. Refer to [Section 9B-4 - Ductile Iron Pipe](#), for bedding types for flexible pressure pipe (AWWA C900 / C905).

Figure 9B-3.03: Flexible Pipe Bedding Types

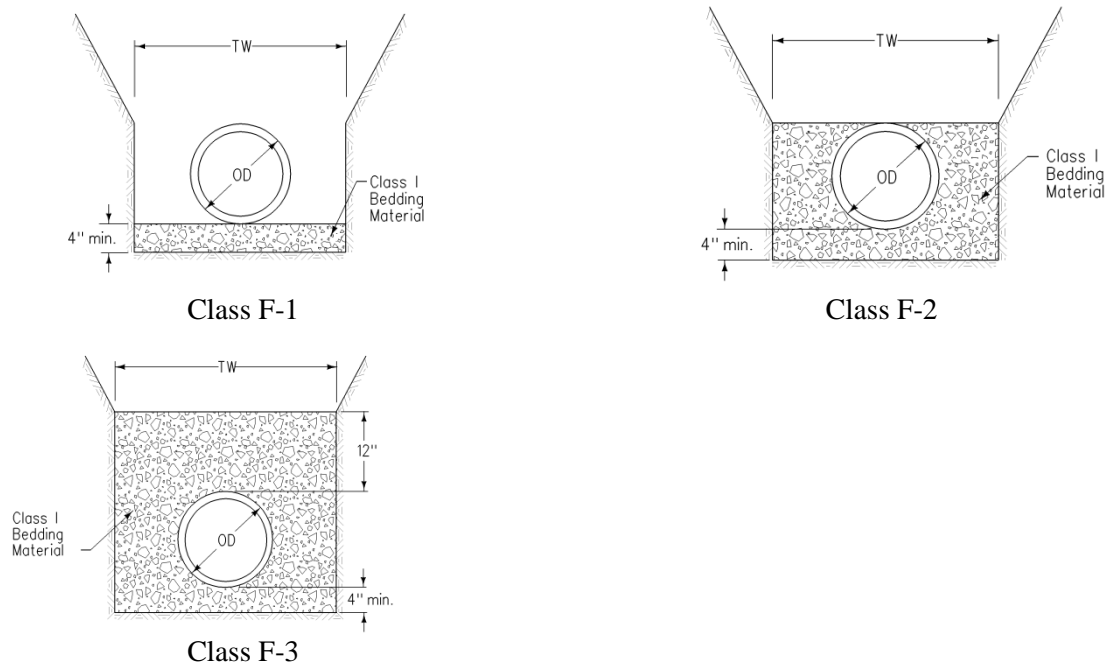

E. Trench Width

1. **Minimum:** Unlike rigid pipe, the load on a flexible pipe does not increase as trench width increases. While trench width does not affect the pipe load, it must be wide enough to properly place and compact the bedding material in the haunch and primary backfill areas of the pipe. Generally, this is considered to be 1.25 times the outside diameter of the pipe plus 12 inches, or the outside diameter of the pipe plus 18 inches, whichever is greater.
2. **Poor Soils:** As mentioned earlier in this section, a critical requirement for flexible pipe performance is sidewall support. In a typical installation, the thrust forces from the sidewall of the deflecting pipe are transferred through the granular bedding material to the trench walls. As these forces pass through the rock envelope, they are distributed over a larger area, reducing the pressure against the trench walls. The crushed stone bedding has a higher bearing capacity, or modulus of soil reaction, than the adjacent soil, allowing it to carry greater loads than the surrounding soil without deformation.

In a typical installation, the granular bedding material reduces the pressure against the trench walls to an acceptable level. However, for installations with poor soil conditions, the in-situ soils may not provide adequate lateral support with a standard trench and pipe bedding. Examples of poor soil conditions include poorly compacted fill with a SPT blow count of five or less, peat, muck, or highly expansive soils. In these situations, additional trench width may be required. A wider trench, and thus a wider rock envelope, allows the thrust forces from the pipe sidewall to be distributed over an even larger area on the trench wall. By increasing the bearing area, the pressure on the trench wall can be reduced to a level that the in-situ soil can support. For conditions with poor soils, increasing the minimum trench width to two times the outside diameter of the pipe is recommended.

F. Pressure Pipe

Using flexible pipes for pressure applications such as water main or sanitary sewer force mains is also common. Unlike flexible pipes for gravity flow applications, pressure pipes are classified based upon the pressure rating of the pipe, rather than the pipe stiffness.

Flexible pressure pipes typically have a significantly thicker wall than gravity flow pipes. As such, the inherent stiffness of the pipe is also significantly greater. For example, C900, DR 18 pipe has an equivalent pipe stiffness of 360 lb/in².

Because of the increased pipe stiffness and relatively shallow depth of bury, bedding requirements for PVC water mains and force mains are less critical than flexible gravity pipe. Native soil can be used for bedding many PVC water main or force main installations. Likewise, the concern of adjacent excavations disturbing the pipes sidewall support is not an issue with PVC pressure pipes. Refer to [Section 9B-4 - Ductile Iron Pipe](#), for typical pressure pipe installations.

Ductile Iron Pipe

A. Introduction

Ductile iron pipe is used primarily as water main, but is also used as force main and for some specialized gravity flow situations. Since the pipe is constructed of ductile iron, it can deflect without failing and behaves similar to a flexible plastic pipe. However, ductile iron pipe has some additional properties that warrant a slightly different design methodology than previously described for flexible plastic pipes.

B. Pipe Design

The first step in analyzing a ductile iron pipe for structural capacity is to determine what pipe thickness to use. Currently, there are two different pipe classifications for ductile iron pipe: Pressure Class and Thickness Class. SUDAS requires Thickness Class 52 pipe for all water main 24 inches or smaller. Unlike PVC pipe, ductile iron pipe does not follow a standardized diameter ratio (DR), so there is no easy method of determining the wall thickness based upon diameter. Pipe standard AWWA C151 indicates the nominal wall thicknesses for Class 52 pipe. However, the values listed in the AWWA standard are not the values used for design purposes. The AWWA values include a casting allowance to ensure that negative thickness deviations do not occur during the casting process. The casting allowance varies from 0.05 to 0.09 inches, depending on diameter. A service allowance of 0.08 inches is also included in the wall thickness to account for material loss from the pipe over its service life. These values are subtracted from the stated wall thickness to determine the design thickness.

Once the design thickness of the pipe is known, the pipe can be analyzed for deflection. Just like flexible pipes, ductile iron can undergo significant deflections without damage. However, the allowable deflection for ductile iron pipe is normally limited to 3%. This limitation is imposed to protect the cement-mortar lining on the inside of ductile iron water pipe.

In addition to deflection limitations, the ring bending stress in the pipe must also be determined. Maximum ring bending stress occurs at the invert of the pipe. If the stress exceeds the yield stress of the ductile iron material, the pipe will undergo permanent deformation.

The equations and procedures for determining pipe deflection and ring bending stress are provided in the Ductile Iron Pipe Research Association's (DIPRA) publication "Design of Ductile Iron Pipe."

C. Bedding

For shallow installations, ductile iron pipe can be installed without granular bedding material. However, the sidewall support from granular bedding material allows ductile iron pipe to carry greater loads than the pipe could by itself. This is an important consideration for deep installations. For example, the maximum depth of bury for a 24 inch Thickness Class 52 ductile iron pipe in a Class P-1 bedding (native soil) is 16 feet. The allowable depth of bury for the same pipe in a Class P-3 bedding (crushed stone encasement) is 38 feet.

Figure 9B-4.01 shows the standard bedding classes for pressure pipe installations. Refer to [Section 9B-3 - Flexible Plastic Pipes](#), regarding bedding requirements for ductile iron pipe when used in a gravity flow installation.

Figure 9B-4.01: Pressure Pipe Bedding Types

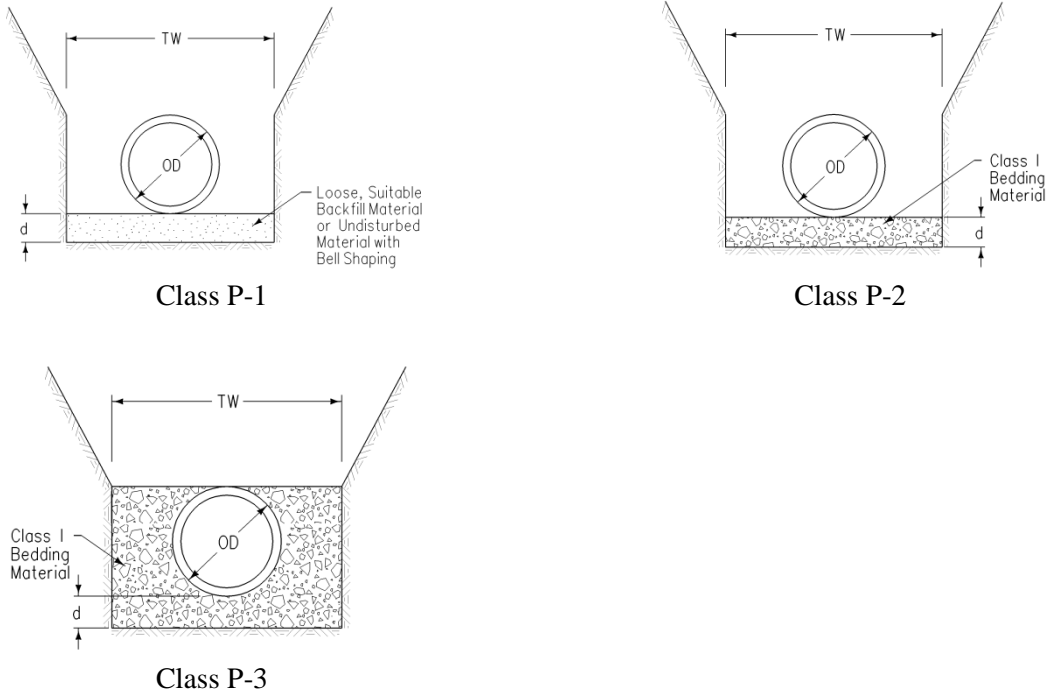

Depth of Bury Tables

A. General

The depth of bury tables on the following pages are based upon the design methodology from the various pipe material associations' design manuals. In order to develop the allowable depth of bury tables, numerous assumptions, including site characteristics and construction methods, were required for each pipe material. In general, when assumptions were required, the values that would provide more conservative results were selected.

For site conditions that differ from the assumptions used for the following tables, a separate calculation should be made with values appropriate to the specific conditions at the proposed project. In order to assist with the lengthy equations involved in some of the pipe design methods, SUDAS has developed a number of spreadsheets that will calculate the allowable depth of bury based upon site conditions entered by the user. These spreadsheets are available on the SUDAS website at iowasudas.org. The spreadsheets follow the design methodology of each pipe material association's design manual. Before using the spreadsheets, the designer should have a thorough understanding of the limitations of each design method.

B. Rigid Pipe Assumptions

The depth of bury calculations for clay pipe were done in accordance with the National Clay Pipe Institute's *Clay Pipe Engineering Manual*. The depth of bury calculations for concrete pipe were done in accordance with the ACPA *Concrete Pipe Design Manual*, utilizing the Marston-Spangler design method. The results of the depth of bury calculations for concrete and clay pipe indicated in Tables 9B-5.01 through 9B-5.05 were developed with the following assumptions:

- Saturated clay backfill – $k\mu' = 0.110$
- Unit weight of backfill = 120 lb/ft³
- D_{0.01} pipe strength with a factor of safety of 1.0 (concrete pipe only)
- A minimum trench width of 54 inches (this is the smallest excavator bucket commonly used by some contractors).
- An HS-20 live load applied in an unpaved condition. If the pipe will not be subjected to live load, the minimum depth of bury does not apply.
- Maximum allowable depth of bury was cut off at 40 feet. Calculated values may exceed this depth, but were not shown. For depths greater than 40 feet, an independent analysis should be done using values for actual site conditions.

Table 9B-5.01: Allowable Depth of Bury for Class III (2000D) RCP

Pipe Diameter (inches)	Bedding Class (feet)				
	R-1	R-2	R-3 and R-4		
			A _s =0.0%	A _s =0.4%	A _s =1.0%
12	2 to 7	1 to 10	1 to 15	1 to 19	1 to 27
15	2 to 8	1 to 10	1 to 16	1 to 19	1 to 27
18	1 to 8	1 to 11	1 to 16	1 to 20	1 to 40
21	1 to 8	1 to 11	1 to 18	1 to 26	1 to 40
24	1 to 8	1 to 12	1 to 23	1 to 36	1 to 40
27	1 to 10	1 to 15	1 to 30	1 to 40	1 to 40
30	1 to 11	1 to 15	1 to 29	1 to 40	1 to 40
33	1 to 11	1 to 15	1 to 28	1 to 40	1 to 40
36	1 to 11	1 to 15	1 to 27	1 to 40	1 to 40
42	1 to 11	1 to 15	1 to 26	1 to 38	1 to 40
48	1 to 11	1 to 15	1 to 26	1 to 36	1 to 40
54	1 to 11	1 to 15	1 to 25	1 to 34	1 to 40
60	1 to 11	1 to 15	1 to 25	1 to 33	1 to 40
66	1 to 11	1 to 15	1 to 24	1 to 32	1 to 40
72	1 to 11	1 to 15	1 to 24	1 to 32	1 to 40

Table 9B-5.02: Allowable Depth of Bury for Class IV (3000D) RCP

Pipe Diameter (inches)	Bedding Class (feet)				
	R-1	R-2	R-3 and R-4		
			A _s =0.0%	A _s =0.4%	A _s =1.0%
12	1 to 12	1 to 15	1 to 23	1 to 28	1 to 40
15	1 to 12	1 to 16	1 to 23	1 to 30	1 to 40
18	1 to 13	1 to 16	1 to 29	1 to 40	1 to 40
21	1 to 13	1 to 18	1 to 40	1 to 40	1 to 40
24	1 to 16	1 to 23	1 to 40	1 to 40	1 to 40
27	1 to 19	1 to 30	1 to 40	1 to 40	1 to 40
30	1 to 19	1 to 29	1 to 40	1 to 40	1 to 40
33	1 to 19	1 to 28	1 to 40	1 to 40	1 to 40
36	1 to 19	1 to 28	1 to 40	1 to 40	1 to 40
42	1 to 18	1 to 27	1 to 40	1 to 40	1 to 40
48	1 to 18	1 to 26	1 to 40	1 to 40	1 to 40
54	1 to 18	1 to 25	1 to 40	1 to 40	1 to 40
60	1 to 18	1 to 25	1 to 40	1 to 40	1 to 40
66	1 to 18	1 to 25	1 to 40	1 to 40	1 to 40
72	1 to 18	1 to 24	1 to 40	1 to 40	1 to 40

Table 9B-5.03: Allowable Depth of Bury for Class V (3750D) RCP

Pipe Diameter (inches)	Bedding Class (feet)				
	R-1	R-2	R-3 & R-4		
			$A_s=0.0\%$	$A_s=0.4\%$	$A_s=1.0\%$
12	1 to 18	1 to 23	1 to 35	1 to 40	1 to 40
15	1 to 19	1 to 24	1 to 40	1 to 40	1 to 40
18	1 to 19	1 to 30	1 to 40	1 to 40	1 to 40
21	1 to 25	1 to 40	1 to 40	1 to 40	1 to 40
24	1 to 34	1 to 40	1 to 40	1 to 40	1 to 40
27	1 to 40	1 to 40	1 to 40	1 to 40	1 to 40
30	1 to 40	1 to 40	1 to 40	1 to 40	1 to 40
33	1 to 40	1 to 40	1 to 40	1 to 40	1 to 40
36	1 to 40	1 to 40	1 to 40	1 to 40	1 to 40
42	1 to 37	1 to 40	1 to 40	1 to 40	1 to 40
48	1 to 35	1 to 40	1 to 40	1 to 40	1 to 40
54	1 to 33	1 to 40	1 to 40	1 to 40	1 to 40
60	1 to 32	1 to 40	1 to 40	1 to 40	1 to 40
66	1 to 31	1 to 40	1 to 40	1 to 40	1 to 40
72	1 to 31	1 to 40	1 to 40	1 to 40	1 to 40

Table 9B-5.04: Allowable Depth of Bury for Reinforced Concrete Arch Pipe

Pipe Size (inches)	Equivalent Diameter (inches)	Pipe Class A-III (feet)	Pipe Class A-IV (feet)
18 by 11	15	2 to 11	2 to 16
22 by 13	18	2 to 11	1 to 20
26 by 15	21	2 to 14	1 to 27
29 by 18	24	2 to 15	1 to 31
36 by 22	30	1 to 15	1 to 29
44 by 27	36	1 to 15	1 to 28
51 by 31	42	1 to 15	1 to 27
58 by 36	48	1 to 15	1 to 26
65 by 40	54	1 to 15	1 to 26
73 by 45	60	1 to 15	1 to 25
88 by 54	72	1 to 15	1 to 25

Table 9B-5.05: Allowable Depth of Bury for Extra Strength VCP

Pipe Diameter (inches)	Bedding Class (feet)				
	R-1	R-2	R-3 & R-4		
			A _s =0.0%	A _s =0.4%	A _s =1.0%
6	1 to 25	1 to 30	1 to 30	1 to 30	1 to 30
8	1 to 20	1 to 26	1 to 30	1 to 30	1 to 30
10	1 to 18	1 to 23	1 to 30	1 to 30	1 to 30
12	1 to 16	1 to 20	1 to 30	1 to 30	1 to 30
15	1 to 15	1 to 19	1 to 28	1 to 30	1 to 30
18	1 to 14	1 to 18	1 to 30	1 to 30	1 to 30
21	1 to 15	1 to 22	1 to 30	1 to 30	1 to 30
24	1 to 18	1 to 28	1 to 30	1 to 30	1 to 30
27	1 to 20	1 to 30	1 to 30	1 to 30	1 to 30
30	1 to 19	1 to 29	1 to 30	1 to 30	1 to 30
33	1 to 20	1 to 30	1 to 30	1 to 30	1 to 30
36	1 to 20	1 to 30	1 to 30	1 to 30	1 to 30
39	1 to 19	1 to 29	1 to 30	1 to 30	1 to 30
42	1 to 18	1 to 26	1 to 30	1 to 30	1 to 30

C. Flexible Pipe Assumptions

The depth of bury calculations for PVC pipe were done in accordance with the Uni-Bell PVC Pipe Association's *Handbook of PVC Pipe: Design and Construction*. The depth of bury calculations for HDPE pipe were done according to the Plastic Pipe Institute's: *The Complete Corrugated Polyethylene Pipe Design Manual and Installation Guide*. The AASHTO design method was used for the determination of live load for both materials. The results of the depth of bury calculations for PVC and HDPE pipe indicated in Tables 9B-5.06, 9B-5.07, and 9B-5.08 were developed with the following assumptions:

1. PVC Assumptions:

- Unit weight of backfill is 120 lb/ft³
- Prism load for backfill
- Deflection lag factor (D_L) of 0.1
- Modulus of soil reaction (E') of 0 psi, 1000, lb/in², and 1000 lb/in² for pipe classes F-1, F-2, and F-3 respectively.
- An HS-20 live load applied in an unpaved condition. If the pipe will not be subjected to live load, the minimum depth of bury does not apply.
- Maximum allowable pipe deflection of 5%. A value of 3% is used for design based upon the published deflection accuracy of ± 2% for dumped crushed rock bedding.
- Maximum allowable depth of bury was cut off at 40 feet. Calculated values may exceed this depth, but were not shown. For depths greater than 40 feet, an independent analysis should be done using values for actual site conditions.

2. HDPE Assumptions:

- Unit weight of backfill is 120 lb/ft³
- Prism load for backfill
- Water table 2 feet below ground surface
- Deflection lag factor (D_L) of 0.1
- Crushed rock bedding with a 1,000 lb/in² modulus of soil reaction (E')

- An HS-20 live load applied in an unpaved condition. If the pipe will not be subjected to live load, the minimum depth of bury does not apply; however sufficient cover should be provided to protect the pipe from damage by ultraviolet radiation or maintenance equipment.
- Maximum allowable pipe deflection of 5%
- Pipe also checked for wall thrust, critical buckling pressure, bending stress, and bending strain.

Table 9B-5.06: Allowable Depth of Bury for Gravity Flow PVC Pipe - Bedding Class F-2 or F-3

Pipe Diameter (inches)	ASTM (feet)					<i>D 2680 Composite</i>
	<i>D 3034 Solid Wall</i>		<i>F 679 Solid Wall</i>	<i>F 949 Corrugated Exterior</i>	<i>F 1803 Closed Profile</i>	
	<i>SDR 26</i>	<i>SDR 35</i>	<i>SDR 35</i>			
8	2 to 28	2 to 24	---	2 to 24	---	2 to 32
10	2 to 28	2 to 24	---	2 to 24	---	2 to 32
12	2 to 28	2 to 24	---	2 to 24	---	2 to 32
15	2 to 28	2 to 24	---	2 to 24	---	2 to 32
18	---	---	2 to 24	2 to 24	---	---
21	---	---	2 to 24	2 to 24	2 to 24	---
24	---	---	2 to 24	2 to 24	2 to 24	---
27	---	---	2 to 24	---	2 to 24	---
30	---	---	2 to 24	2 to 24	2 to 24	---
33	---	---	2 to 24	---	---	---
36	---	---	2 to 24	2 to 24	2 to 24	---
42	---	---	2 to 24	---	2 to 24	---
48	---	---	2 to 24	---	2 to 24	---
54	---	---	---	---	2 to 24	---
60	---	---	---	---	2 to 24	---

Table 9B-5.07: Allowable Depth of Bury for AWWA C900/C905 PVC Pressure Pipe

Pipe Diameter (inches)	Bedding Class (feet)		
	<i>P-1</i>	<i>P-2</i>	<i>P-3</i>
4	2 to 19	2 to 40	2 to 40
6	2 to 19	2 to 40	2 to 40
8	2 to 19	2 to 40	2 to 40
10	2 to 19	2 to 40	2 to 40
12	2 to 19	2 to 40	2 to 40
14	2 to 19	2 to 40	2 to 40
16	2 to 19	2 to 40	2 to 40
18	2 to 19	2 to 40	2 to 40
20	2 to 19	2 to 40	2 to 40
24	2 to 19	2 to 40	2 to 40

Table 9B-5.08: Allowable Depth of Bury for HDPE Pipe - Bedding Class F-2 or F-3

Pipe Diameter (inches)	AASHTO M 294 (feet)
6	2 to 8
8	2 to 8
10	1 to 9
12	2 to 8
15	1 to 9
18	1 to 9
24	1 to 9
30	1 to 9
36	1 to 9
42	1 to 8
48	1 to 8
54	1 to 8
60	1 to 8

- 3. Polypropylene Assumptions:** The depth of bury calculations for polypropylene pipe were completed in accordance with the AASHTO LRFD Bridge Design Specifications, Sixth Edition. Most of the design criteria are as noted below and the remaining load factors and modifiers are as specified in AASHTO.
- General Design Criteria
 - Design Interval: 50 years
 - Live load applied per NCHRP 647 (checked against AASHTO LRFD)
 - Deflection limit: $\Delta_A = 5\%$
 - Site Assumptions:
 - Clay soils
 - Groundwater assumed 2 feet below ground surface
 - Unit weight of wet soil: $g_s = 120$ pcf
 - Void ratio of soil: $e = 1.9$ (soft, slightly organic clay)
 - Installation Properties
 - Soil compaction: 90% (note: 95% is required by the specs, but a lower value was used for design to recognize the fact that trench compaction is difficult to achieve and sometimes lacking).
 - Pipe Embedment Material: Crushed stone envelope
 - Pipe Embedment Material Compaction: Dumped condition
 - Bedding coefficient = $K_B = 0.100$
 - Deflection lag factor: $D_L = 1.5$
 - AASHTO Load Factors & Modifiers
 - Factor for uncertainty in groundwater: $K_{wa} = 1.0$
 - Installation Factor: $K_{gE} = 1.5$
 - Coefficient for Variation of Thrust: $K_2 = 1.0$ (at springline)
 - Load Factor for vertical earth pressure: $g_{EV} = 1.3$

Table 9B-5.09: Allowable Depth of Bury for Polypropylene Pipe

Pipe Diameter (inches)	ASTM F 2736 (feet)	ASTM F 2764 (feet)
12	24	---
15	25	---
18	22	---
24	20	---
30	22	22
36	---	21
42 ¹	---	22
48 ¹	---	23
54 ¹	---	21
60 ¹	---	21

¹ Storm Sewer only.

Minimum depth of cover for all diameters 12 to 54 inches is 1 foot. Minimum cover for 60 inch pipe is 2 feet.

D. Ductile Iron Pipe Assumptions

The depth of bury calculations for ductile iron were done according to the DIPRA publication “Design of Ductile Iron Pipe.” The results of the depth of bury calculations for ductile iron pipe indicated in Table 9B-5.09 were developed with the following assumptions:

- Unit weight of backfill is 120 lb/ft³
- Prism load for backfill
- An HS-20 live load applied for all conditions
- Live load impact factor of 1.5
- Bedding classes P-1, P-2, and P-3 follow DIPRA laying conditions Type 2, Type 4, and Type 5, respectively.
- Maximum allowable pipe deflection of 3%
- 48,000 psi ring bending stress limit.
- Maximum allowable depth of bury was cut off at 40 feet. Calculated values may exceed this depth, but were not shown. For depths greater than 40 feet, an independent analysis should be done using values for actual site conditions.

Table 9B-5.10: Allowable Depth of Bury for Ductile Iron Pipe (Thickness Class 52)

Pipe Diameter (inches)	Bedding Class (feet)		
	<i>P-1</i>	<i>P-2</i>	<i>P-3</i>
4	2.5 to 40	2.5 to 40	2.5 to 40
6	2.5 to 40	2.5 to 40	2.5 to 40
8	2.5 to 40	2.5 to 40	2.5 to 40
10	2.5 to 36	2.5 to 40	2.5 to 40
12	2.5 to 31	2.5 to 40	2.5 to 40
14	2.5 to 26	2.5 to 40	2.5 to 40
16	2.5 to 23	2.5 to 37	2.5 to 40
18	2.5 to 20	2.5 to 34	2.5 to 40
20	2.5 to 18	2.5 to 32	2.5 to 40
24	2.5 to 16	2.5 to 29	2.5 to 38
30	2.5 to 13	2.5 to 23	2.5 to 31
36	2.5 to 13	2.5 to 22	2.5 to 30
42	2.5 to 13	2.5 to 21	2.5 to 29
48	2.5 to 13	2.5 to 19	2.5 to 27
54	2.5 to 13	2.5 to 19	2.5 to 27

Casing Pipe

A. General

Utilities must often be encased in a steel pipe when crossing under roadways or railroads. Steel casing pipe complying with the requirements of ASTM A252 (Standard Specification for Welded and Seamless Steel Pipe Piles) is generally used.

Depending on the timing of the installation, the casing pipe can be either installed in an open cut trench or by one of the trenchless techniques described in [Chapter 14](#).

Regardless of the installation method, the casing pipe thickness and casing pipe diameter should be specified on the plans.

B. Casing Thickness

The casing pipe must have sufficient thickness to withstand both earth loads and any live loads imposed from traffic above. Table 9C-1.01 provides minimum recommended casing pipe thicknesses for both roadway and railroad installations. The roadway values are based upon common industry standards. The railroad values are based upon American Railway Engineering and Maintenance-of-Way Association (AREMA) design standards. Individual railroad standards may vary.

Table 9C-1.01: Minimum Casing Pipe Thickness

Nominal Diameter (inches)*	Roadway (inches)	Railroad (inches)
6 through 14	0.250	0.25
16	0.250	0.281
18	0.250	0.312
20	0.250	0.344
24	0.281	0.375
30	0.312	0.469
36	0.344	0.531
42	0.344	0.625
48	0.344	0.687
54		0.719
60		0.843
66		0.937
72		1.000

*Additional casing diameters are available.

Notes: Minimum thicknesses assume a minimum of 4.5 feet of cover over top of pipe.

C. Casing Diameter

The casing pipe should be sized to provide a minimum of 4 inches of clearance between the inside of the casing pipe and the largest outside diameter of the carrier pipe (including pipe bells) to allow for deflection of the casing pipe and installation of casing spacers.

Utility Cut Restoration

A. General

Utility cuts are made in existing pavement sections to install a myriad of utilities and to repair those that experience maintenance needs. Once a utility cut is made in the pavement, the restoration materials and process will have a significant impact on the life of the pavement patch. When a utility cut is made, the native material surrounding the perimeter of the trench is subjected to loss of lateral support. This leads to loss of material under the pavement and bulging of the soil on the trench sidewalls into the excavation. Subsequent refilling of the excavation does not necessarily restore the original strength of the soils in this weakened zone. The weakened zone around a utility cut excavation is called the “zone of influence.” Poor performance of pavements over and around utility trenches on local and state systems often causes unnecessary maintenance problems due to improper backfill placement (i.e., under compacted, too wet, too dry). It has been reported that the life of a utility cut replacement patch is only 2 to 3 years. The costs of repairing poorly performing utility cut restorations can potentially be avoided with a better understanding of proper material selection and construction practices. In addition to the resources spent by the public agency to maintain the pavement patch area, there is a significant impact to the traveling public due to rough streets and the traffic interruptions that occur frequently when maintenance activities are occurring.

The improper use and placement of backfill materials and failure to provide for the loss of lateral support of the trench walls are the primary causes of pavement patch failure.

While planning of utility modifications can be accommodated as part of a larger project, frequently these excavations occur at odd-hours and with no advance notice to repair a facility (i.e., water main break). It is therefore important to plan ahead to help ensure that desirable methods are used to restore utility trenches, even when weather, timing, or other factors may be less than ideal.

B. Background

The Iowa Highway Research Board (IHRB) commissioned two projects focusing on how best to reconstruct utility trenches. The goal of the projects has been to mitigate the negative effects utility trenches have on the surrounding roadway pavement. The two studies are described below.

- IHRB Project TR-503 (2005) Utility Cut Repair Techniques - Investigation of Improved Cut Repair Techniques to Reduce Settlement in Repaired Areas
- IHRB Project TR-566 (2010) Utility Cut Repair Techniques - Investigation of Improved Utility Cut Repair Techniques to Reduce Settlement in Repaired Areas, Phase II

The above reports can be accessed at the following websites:

- www.intrans.iastate.edu
- <https://iowadot.gov/research/research/reports-library>

The research identified the following problems with current trench restoration methods:

- Large equipment bearing on the trench edges (causing damage to the trench sidewalls and the remaining pavement)

- 2 to 4 foot lifts of backfill material
- Sporadic compaction of the backfill lifts
- Utilizing native, saturated material in the excavation in an attempt to clean the excavation site
- General lack of density and moisture quality control

The research identified three modes of failure for the utility trenches.

- Settlement of utility cut restoration, caused by poor compaction and wet/frozen conditions
- A “bump” forming over the restoration, resulting from uplift or settlement of surrounding soil
- Weakening of the surrounding soils

Many of the studied patches showed signs of failure within 2 years.

C. Factors Affecting Patch Performance

- 1. Compaction:** Proper compaction of the non-manufactured backfill material is a critical element of good trench construction. Use of granular backfill has previously been thought of as a means to achieve an acceptable level of trench compaction with a minimal level of effort; however, that is not the case. Even with granular materials, the material should be placed in lifts not exceeding 12 inches in thickness. Each lift of granular material should receive an appropriate level of compactive effort to achieve a minimum relative density of 65%. If cohesive soils are used in the top 2 feet to match existing subgrade materials, the soil should be placed in 8 inch lifts and compacted to 95% of Standard Proctor Density for that soil.

Backfill materials are often compacted using large compaction equipment, which is placed close to the edges of the cut, resulting in damage to pavement surfaces around the perimeter of the excavation. Note Figure 9D-1.01. It is important to keep equipment away from the edges of the trench.

Figure 9D-1.01: Cracking Pavement Surrounding the Utility Cut Area Because of Construction Equipment Getting Too Close to the Edge of the Open Cut



Source: IHRB Project TR-566

Figure 9D-1.02: Large Lift Thicknesses Used in Utility Cut Trench Backfill Material Placement

Source: IHRB Project TR-566

- 2. Use of Appropriate Backfill Material:** Class I and Class II backfill material, according to [SUDAS Specifications Section 3010](#), should be used to place backfill material in the trench. The Engineer can change the gradation to meet locally acceptable materials, including crushed concrete pavement. Backfill materials classified as SM (silty sands) or GC (clayey gravel) with less than 35% sand will achieve relative densities of dense to very dense without a significant amount of compaction. In addition to non-manufactured soils, manufactured products such as flowable mortar and controlled low strength material (CLSM) can be used. These manufactured products do not require compaction, but they do cost more.
- 3. Frost Heave:** One of the major impacts to trench performance is seasonal effects such as frost heave. Frost is known to cause two main problems. First, frost changes the stiffness of the soil structure during freeze and thaw cycles. As frost forms, the pavement structure stiffens. When frost thaws, the increase in water content in the soil causes the pavement structure to weaken. Second, displacements are caused by the formation of ice lens and the pressure on related structures, which are normal to the growth of the lens.

As frost forms in a soil, a frozen fringe develops (see Figure 9D-1.03). This fringe develops at freezing temperatures and extends downward. The frozen fringe forms below where an active ice lens is forming. As freezing temperatures penetrate deeper in a soil, the frozen fringe and zone of active lens formation also migrate downward. The active ice lens layer in the soil is also a boundary where the permeability of the soil decreases because the pores begin filling with ice. This boundary prevents water from traveling upward beyond the active lens zone. Because of this, no additional ice lens will form above the active ice lens zone. The downward movement of the frozen fringe affects the size of the ice lens. When the front advances rapidly through a soil, the lens will be thin; however, when the frozen fringe remains at a stationary point because of the heat flow balance, a larger lens will form.

As ice lenses form, they exert an outward pressure on the pore. When the pressures are greater than the overburden pressures, the soil will heave. The heave (expansion of soil) occurs at the

frost line, which is assumed to be at freezing. Frozen soils above the frost line do not expand because there is no influx of moisture.

Figure 9D-1.03: Frost Heave in Idealized One-Dimensional Soil Column

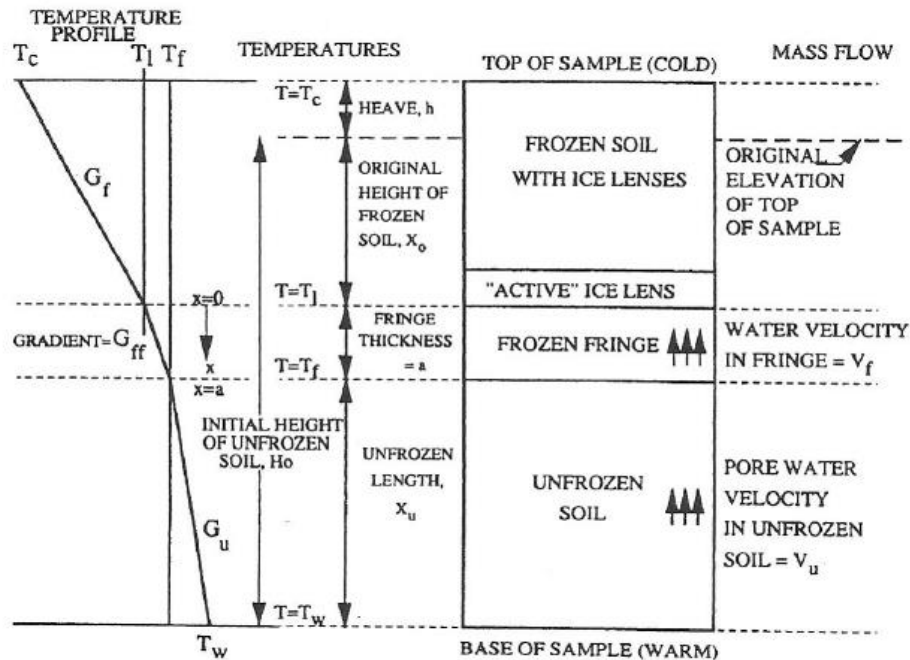

Source: IHRB Project TR-566

Soils do not need to be saturated to experience frost formation. Conversely, when a soil is at freezing temperatures, not all of the water is frozen.

The frost susceptibility of a soil is a function of particle and void size. Gravels have large voids and large particles. This allows water to flow freely through the soil. When water does freeze in gravel, the void size is large enough so that as the frozen fringe passes through, the lens cannot grow large enough to displace the particles. Clays, at the other end of the gradation chart, have very small particles and small voids. Less force is required to displace smaller soil particles than larger particles, such as gravels. This makes soils with high percentages of fines more susceptible to frost.

- 4. Zone of Influence:** The zone of influence is an area immediately adjacent to and outside the trench where the soils are adversely affected by the nearby excavation. The effects in this zone are caused by changes to the soil that remains in place during a trench excavation. The trench walls, usually close to vertical, are not capable of withstanding their normal loads and tend to experience sloughing due to loss of lateral support. In all cases, there is subsidence that creates a weakened plane in the soil. This weakened plane, if it is not addressed, is one of the primary reasons for trench/pavement patch failure. This can lead to undercutting of the existing pavement that was originally planned to remain in place. These effects are detailed in Figure 9D-1.04. The damage to the supporting nature of the soils is very difficult to repair and results in an isolated weak column of soil surrounding the entire excavation.

The research has pointed out that the zone of influence can extend between 2 and 3 feet from the top of the trench wall. Thus, prior to replacement of the pavement, the area should be cut back a

minimum of 3 feet and to a depth of 2 feet. This top area should then be filled with backfill materials matching the existing subgrade/subbase to provide uniform pavement support.

As can be seen in Figure 9D-1.05, the zone of influence, in this case approximately five to six feet in width, performed significantly poorer than both the existing, undisturbed pavement section, and the properly constructed trench backfill. This increased deflection implies that the pavement is moving relative to the surrounding pavement, increasing the likelihood of crack formation and premature pavement deterioration.

Figure 9D-1.04: Overstressing of the Pavement and Natural Materials Adjacent to the Trench

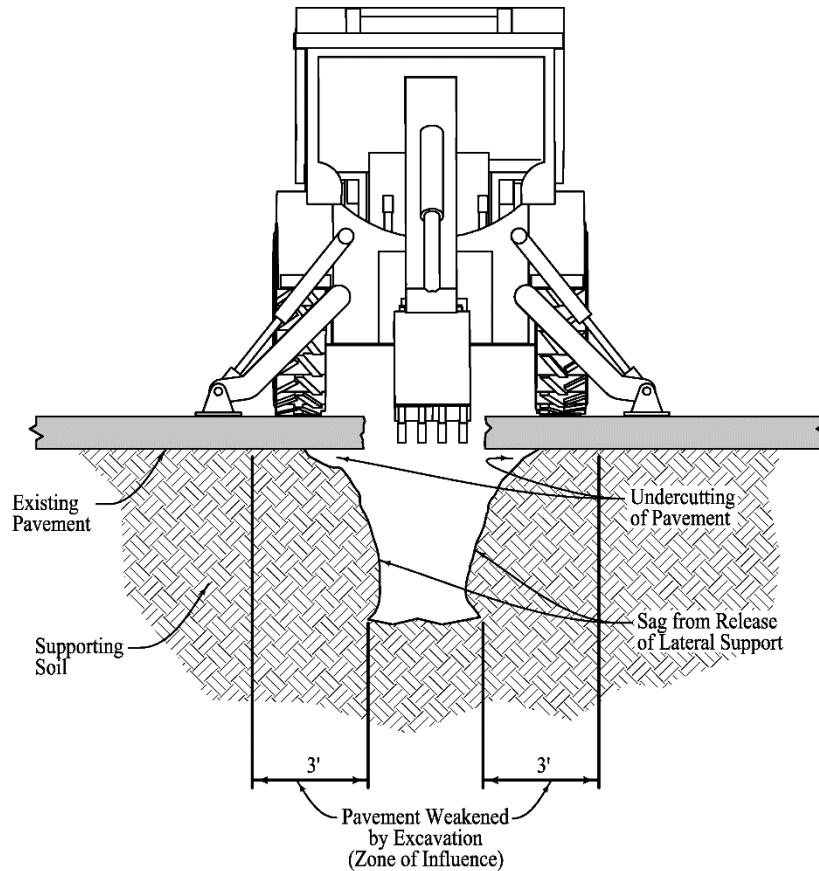

Source: IHRB Project TR-503

Figure 9D-1.05: Locations and Results of FWD Tests Performed at a Utility Cut Location Showing Deflection Within the Zone of Influence

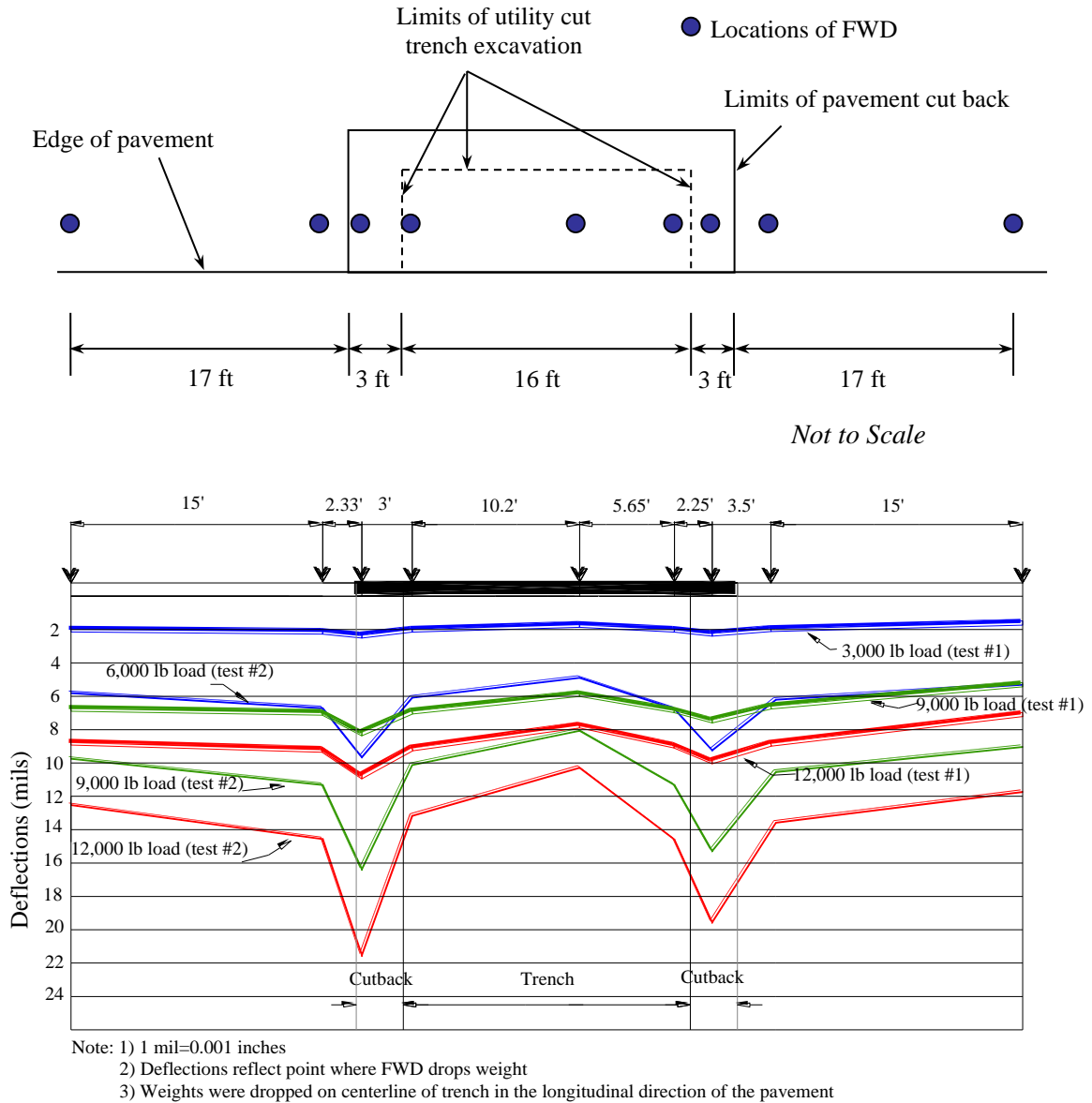

Source: IHRB Project TR-566

The charts above were recorded using a Falling Weight Deflectometer (FWD). This tool, providing a non-destructive measurement, drops a weight from a controlled height and measures the resulting pavement deflection using an array of sensors placed along a line. This line is usually orientated along the direction of travel for the roadway. Figure 9D-1.07 shows the Iowa DOT's FWD.

Figure 9D-1.06: Iowa DOT FWD Equipment Showing Sensor Configuration

Source: IHRB Project TR-566

- 5. Moisture Content of Backfill Material and Collapse Potential:** It is critical that the bulking moisture content of the granular material be exceeded in order to achieve a dense backfill condition. Bulking is a phenomena that occurs in most granular materials in which the capillary action between soil particles that are surrounded by water hold the particles together in a honeycombed structure as noted below. The material starts out dry. With the addition of some water, the soil particles are surrounded. As more water is introduced, generally to a moisture content of approximately 6% to 10%, suction forms between the soil particles that creates tension and air voids. With the addition of more water, generally above 10%, the tension is released. This rearrangement of particles is referred to as collapse of granular materials. This phenomena is shown in Figure 9D-1.07.

When the tension releases, the collapse occurs, leading to a denser material, and reduced trench settling. Thus, it is very important that the granular backfill materials be placed in the trench above the bulking moisture content. The bulking moisture content range (i.e., the range of moisture contents to avoid can be determined in the laboratory and the range is defined as the moisture content for the maximum collapse potential plus or minus 2%.

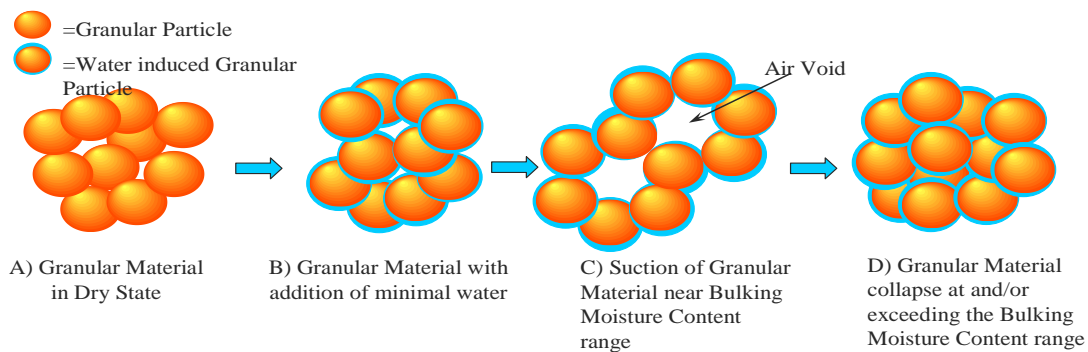
Figure 9D-1.07: Bulking Moisture Content

Source: IHRB Project TR-503

6. **Quality Control:** If granular materials are used for the primary backfill material as recommended, the level of density must be checked and compared to the relative density of the material. Use of Standard Proctor Density does not provide an appropriate level of results for the density of granular materials. See [Chapter 6 - Geotechnical](#) for more information on relative density and Proctor density. Use of the Dynamic Cone Penetrometer (DCP), which involves measurements of penetration of the rod into the backfill material, is another method of determining density. The greater the number of blows to penetrate a given depth, the stiffer the material. The Clegg Hammer operates on the same general principle.

D. Recommended Utility Trench

The recommended trench configuration and recommended best practices to increase performance of pavement patches over utility trench repairs are shown below. It is important to note that all of these recommendations must be implemented in order to have improved pavement life.

1. Equipment:

- Throughout construction of the trench, including excavation and placement of backfill material, keep equipment and materials as far away from the trench area as possible to minimize trench wall sloughing.
- The smallest equipment which can satisfactorily perform the job should be used to minimize the adverse effects caused by equipment loading near the edges of the excavation.

2. Trench Excavation:

- Soils excavated from the trenches or other soils should not be mixed with the granular backfills unless previous laboratory testing yielding a range of recommended moisture content and densities to be achieved in the field are conducted.
- The T-section should be modified to use walls that are beveled outward to facilitate compaction of backfill. Beveled edges will reduce the amount of disturbance to the surrounding soil and also eliminate the vertical excavation, which makes compacting the backfill more difficult.
- Refrain from using saturated material from the excavation.

3. Backfill:

- Reduce lift thickness to 8 inches to 12 inches for backfill materials
- The standard vertical-walled cross-section with 1 inch clean limestone is recommended as a construction practice.
- Quality control measures should be implemented in the field. These should include methods to ensure compaction and moisture requirements are met. This includes achieving at least medium relative density with moisture contents above the bulking moisture content for cohesionless soils and above 95% of Standard Proctor and $\pm 2\%$ of optimum moisture content for cohesive soils.
- Place geotextiles in the bottom of the cutback area prior to placement of subgrade/subbase material.

4. Pavement Surfacing:

- Saw the pavement full depth to create the cutback area three feet from edge of the original trench.
- Recompact the top 12 inches of trench backfill material after removal of cutback materials.
- PCC patches seem to perform better regardless of the existing pavement type. This is due in part to the difficulties in completing uniform compaction of HMA in relatively small areas.

Figure 9D-1.08: Recommended Trench Reconstruction

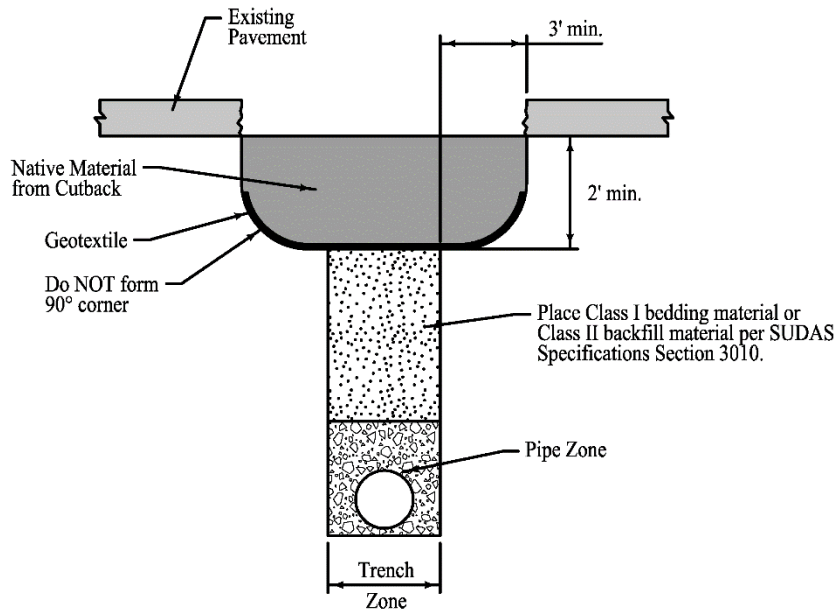



References

American Association of State Highway and Transportation Officials (AASHTO). *Policy on Geometric Design of Highways and Streets*.

American Association of State Highway and Transportation Officials (AASHTO). *Road Side Design Guide*.

American Concrete Pipe Association. *Concrete Pipe Design Manual*. Irving, Texas. 2000.

American Petroleum Institute

American Water Works Association. *Underground Installation of PVC Pressure Pipe and Fittings for Water*. AWWA C605. Denver, Colorado. 2005.

ANSI Standard Code for Pressure Piping

Ductile Iron Pipe Research Association. *Design of Ductile Iron Pipe*. Birmingham, Alabama. 2006.

Federal Highway Administration (FHWA). *Highway/Utility Guide*. 1993.

Federal Highway Administration and Iowa Department of Transportation. *Utility Accommodation Policy*.

Lester H. Gabriel, Ph.d, P.E. *The Complete Corrugated Polyethylene Pipe Design Manual and Installation Guide*, Plastic Pipe Institute. Irving, Texas.

National Clay Pipe Institute. *Clay Pipe Engineering Manual*. Lake Geneva, Wisconsin. 1995.

National Electrical Safety Code and Iowa Electrical Safety Code Guidelines

Schaefer, V.R., M.T. Suleiman, D.J. White, and C. Swan. *Utility Cut Repair Techniques - Investigation of Improved Utility Cut Repair Techniques to Reduce Settlement in Repaired Areas*. Iowa: Report No. TR-503, Iowa Department of Transportation. 2005.

Suleiman, M, K. Videkovich, L. Stevens, V. Schaefer, and H. Ceylan. *Investigation of Improved Utility Cut Repair Techniques to Reduce Settlement in Repaired Areas, Phase II*. 2010.

Uni-Bell PVC Pipe Association. *Handbook of PVC Pipe, Design and Construction*. Dallas Texas. 2001.