



---

# Table of Contents

---

## Chapter 11 - Street Lighting

### 11A General Information

11A-1-----	General Information	
A.	General.....	1
B.	Iowa Code.....	1
C.	Industry Outlook.....	3
D.	Definitions.....	3
E.	References.....	6

### 11B Luminaires

11B-1-----	Luminaires	
A.	Lighting Sources.....	1
B.	Light System Depreciation.....	2
C.	Luminaire Light Distribution Classifications.....	4
D.	References.....	10
11B-2-----	LED Lighting	
A.	LED vs. HPS Lighting.....	1
B.	LED Lighting Advantages.....	2
C.	LED Lighting Disadvantages.....	3

### 11C Facility Design

11C-1-----	Facility Design	
A.	General.....	1
B.	Design Process.....	2
C.	References.....	9



---

# General Information

---

## A. General

Darkness brings increased hazards to users of urban streets because it reduces the distance they can see. The nighttime fatal accident rate on unlighted roadways is about three times the daytime rate, based on proportional vehicular miles of travel. This ratio can be reduced when proper fixed street lighting systems are installed.

Good visibility under night conditions is one of the fundamental requirements enabling motorists to move on roadways in a safe and coordinated manner during the nighttime hours. Properly designed and maintained street lighting will produce quick, accurate, and comfortable visibility at night, which will safeguard, facilitate, and encourage both vehicular and pedestrian traffic. Other objectives of street lighting include:

- Improvement of traffic flow at night by providing light, beyond that provided by vehicle lights, which aids drivers in orienting themselves, delineating roadway geometries and obstructions, and determining relationship to other motorists.
- Aid in police protection and enhanced sense of personal security.
- Promotion of business commerce and the use of public facilities during the nighttime hours.

Street lighting design is concerned with the selection and location of lighting equipment to provide improved visibility and increased safety while making the most efficient use of energy with minimum expenditure. This chapter focuses on the street lighting design approach of urban local, collector, and arterial streets. This chapter does not include guidelines for rural or freeway roadway types.

This chapter makes use of state-of-the-art lighting science and internationally and nationally recommended street lighting design practices to facilitate the quality and energy efficient design of street lighting on Iowa's urban roadways. This design guidance relies on roadway lighting guidelines issued by the Illuminating Engineering Society (IES). IES is considered the nation's technical authority on illumination. The independent, member-based professional organization synthesizes research, investigations, and discussions to develop lighting design recommendations intended to promote good lighting practice. Many of the items in this chapter are references from ANSI IES RP-8-14, *Roadway Lighting*, (RP-8) publication.

## B. Iowa Code

Although there are many options for the type of luminaire to be used for street lighting projects, Iowa Code states all new or replaced luminaires shall be replaced with high pressure sodium (HPS) lighting or lighting with equivalent or better energy efficiency. Following are excerpts from the current Iowa Code that pertain to publicly owned exterior lighting. Many of the lighting terms used in the following cited Iowa Code sections will be defined in the definition list and detailed further in this chapter.

1. **Facilities Owned By Cities:** Iowa Code Section 364.23 below pertains to facilities owned by cities. It is understood the reference to "era or period lighting" is in relation to architectural or ornamental lighting of historical significance, often found in downtown locations.

**“364.23 Energy-efficient Lighting Required:** All city-owned exterior flood lighting, including but not limited to street and security lighting but not including era or period lighting which has a minimum efficiency rating of fifty-eight lumens per watt and not including stadium or ball park lighting, shall be replaced, when worn-out, exclusively with high pressure sodium lighting or lighting with equivalent or better energy efficiency as approved in rules adopted by the utilities board within the utilities division of the department of commerce. In lieu of the requirements established for replacement lighting under this section, stadium or ball park lighting shall be replaced, when worn-out, with the most energy-efficient lighting available at the time of replacement which may include metal halide, high-pressure sodium, or other light sources which may be developed.”

2. **Facilities Owned By Public Utilities:** Iowa Code Section 476.62 below pertains to facilities owned by public utilities.

**“476.62 Energy-efficient Lighting Required:** All public utility-owned exterior flood lighting, including but not limited to street and security lighting, shall be replaced when worn-out exclusively with high pressure sodium lighting or lighting with equivalent or better energy efficiency as approved in rules adopted by the board.”

3. **Utilities Board Rules:** Iowa Administrative Code (IAC) 199-35.15 (476) contains the rules adopted by the Utilities Board within the Utilities Division of the Department of Commerce that are referenced in the two Iowa Code sections stated above and pertain to exterior lighting energy efficiency. It is understood one of the five conditions of IAC 199-35.14(476) must be met in order to use a light source other than high-pressure sodium for exterior lighting applications.

#### **“199-35.15(476) - Exterior Flood Lighting**

**35.15(1) - Newly Installed Lighting:** All newly installed public utility-owned exterior flood lighting shall be high-pressure sodium lighting or lighting with equivalent or better energy efficiency.

**35.15(2) - In-service Lighting Replacement Schedule:** In-service lighting shall be replaced with high-pressure sodium lighting or lighting with equivalent or better energy efficiency when worn out due to ballast or fixture failure for any other reason, such as vandalism or storm damage. A utility shall file with the board as part of its annual report required in 199-Chapter 23 a report stating progress to date in converting to high-pressure sodium lighting or lighting with equivalent or higher energy efficiency.

**35.15(3) - Efficiency Standards:** Lighting other than high-pressure sodium has equivalent or better energy efficiency if one or more of the following can be established:

- a. For lamps less than 120 watts, the lumens-per-watt lamp rating is greater than 77.1, or
- b. For lamps between 120 and 500 watts, the lumens-per-watt lamp rating is greater than 96, or
- c. For lamps greater than 500 watts, the lumens-per-watt lamp rating is greater than 126, or
- d. The new lighting uses no more energy per installation than comparable, suitably sized high-pressure sodium lighting, or
- e. The new lighting consists of solid-state lighting (SSL) luminaries that have an efficacy rating equal to or greater than 66 lumens per watt according to a Department of Energy (DOE) Lighting Facts label, testing under the DOE Commercially Available LED Product Evaluation and Reporting Program (CALiPER), or any other test that follows Illuminating Engineering Society of North America LM-79-08 test procedures.”

Prior to the fall of 2010, the language in IAC 199-35.15(3) was different and used strictly the bare lamp efficacy rating of HPS lamps as the basis of comparison to qualify other lighting source types as

energy efficient. Because of the way light emitting diode (LED) lighting is constructed and produces light, the IAC excluded the use of LED lighting even though it could be demonstrated that in many street lighting applications, current LED lighting was more energy efficient. Therefore, the IAC was revised in the fall of 2010 to the language shown above. The IAC still sets HPS lighting as the energy efficient standard; however, other lighting source types can be used if they pass one of the five stated conditions. The first three conditions (a, b, and c) are a modification from the IAC prior to 2010 and generally apply to high intensity discharge (HID) or other single-lamp type luminaires.

Condition 'd' is intended to apply to lighting replacement or retrofit applications. Again, the IAC uses HPS as the comparison standard. Bear in mind the condition says "suitably sized" HPS lighting. For a defined project area, this requires the designer to compare the energy consumption of the proposed lighting system type (other than HPS) to the energy consumption of HPS lighting if it is properly applied meeting the same illumination criteria. The designer should be forewarned to not necessarily use the existing lighting system, particularly if it is HPS, as the basis of energy consumption for the replacement project because the project area may be over lit by the existing lighting. It is generally understood that the illumination criteria published in RP-8 for roadway lighting is to be used in the comparison process.

Condition 'e' is intended to apply strictly to LED lighting when installed in new lighting project applications. This requires the luminaires to have a luminaire efficacy rating of at least 66 lumens per watt as established by a proper industry testing procedure.

## C. Industry Outlook

At this time, LED lighting technology has replaced HPS as the predominant type of light source used for street lighting. LEDs have surpassed HPS in energy efficiency and total fixture efficacy, exceeding those outlined in the Iowa Code, for most typical uses. At this time of this revision, LED technology may not exceed the requirements for the 500 watt fixtures except from limited manufacturers.

LED technology continually evolves. From the previous edition of the SUDAS Street Lighting guide (2013), LEDs have evolved in light output from around 60 lumens per watt to 150 lumens per watt (2019). LED technology is the exterior lighting of today, being used from decorative housing/building landscaping to parking lot/street lighting to major sports stadiums. This is due to the previously stated energy efficiency and color recognition.

As will be discussed in [Section 11C-1](#), there are two basic concepts of lighting design, the illumination concept and the luminance concept. The current edition of RP-8 discusses and supports both design concepts, depending on site criteria. For straight road segments, RP-8-14 recommends utilizing the luminance method. However, for curved roadways, intersections, and walkways, illumination method is recommended. Since the majority of local ordinances are based on the illumination method, both methods will be discussed in this chapter.

## D. Definitions

**Average Maintained Illuminance:** The average level of horizontal illuminance on the roadway pavement when the output of the lamp and luminaire is diminished by the maintenance factors; expressed in average footcandles for the pavement area.

**Ballast:** A device used with an electric-discharge lamp to obtain the necessary circuit conditions (voltage, current, and wave form) for starting and operating the lamp.

**Bracket or Mast Arm:** An attachment to a lighting standard or other structure used for the support of a luminaire.

**Candela (cd):** The unit of luminous intensity. Formerly the term "candle" was used. Refer to Figure 11A-1.01.

**Coefficient of Utilization Curve (CU):** This curve shows the percentage of the total light output that will fall on the roadway. Mounting height and horizontal dimensions transverse to the roadway relative to the luminaire position must be known to apply the curve. Refer to [Figure 11C-1.02](#).

**Efficacy (Luminous Efficacy):** The quotient of the total luminous flux delivered from a light source divided by the total power input to the light source. It is expressed in lumens per watt (l/w).

**Footcandle (fc):** One footcandle is the illumination incident on a surface one square foot in area on which there is uniformly distributed a luminous flux of one lumen. Footcandle is the English unit for illumination. The metric or SI unit is lux. One footcandle equals 10.76 lux. Refer to Figure 11A-1.01.

**Foot-lambert (fl):** The unit of photometric brightness (luminance). It is equal to  $1/\pi$  candela per square foot. One foot-lambert equals 3.426 candelas per square meter.

**High Intensity Discharge (HID):** A term applied to a category of electric lamps that produce light by means of an electric arc sustained between tungsten electrodes housed inside a translucent or transparent fused quartz or fused alumina arc tube filled with gas and metal salts. The gas facilitates the arc's initial strike. Once the arc is started, it heats and evaporates the metal salts forming a plasma, which greatly increases the intensity of light produced by the arc and reduces its power consumption. High intensity discharge lamps are a type of arc lamp.

**Horizontal Footcandle:** One lumen distributed uniformly over a horizontal surface one square foot in area. Thus, horizontal footcandle is a measure of illumination from light that strikes a horizontal surface such as the pavement.

**Illuminance:** The density of the luminous flux incident on a surface. It is the quotient of luminous flux by area of the surface when the latter is uniformly illuminated (measured in footcandles). Refer to Figure 11A-1.01

**Initial Lamp Lumens:** Manufacturer's published initial bare lamp lumen output of a new lamp.

**Isocandela Diagram:** A series of lines plotted in appropriate coordinates to show directions in space at which the candlepower is the same.

**Isofootcandle Diagram:** This diagram is available from the manufacturer of the light source and shows the horizontal footcandles on the pavement surface at various points away from the source. Mounting height must be known to properly use the diagram. Refer to [Figure 11C-1.02](#).

**Lamp Lumen Depreciation Curve (LLD):** This curve gives information on the relationship between length of service and light output. All lamps deteriorate with time, and total light output becomes less. Refer to [Figure 11B-1.01](#).

**Lamp:** A generic term for a man-made source of light that is produced either by incandescence or luminescence.

**Lighting Standard:** The pole with or without bracket or mast arm used to support one or more luminaires.

**Lighting Unit:** The assembly of pole or standard with bracket and luminaire.

**Longitudinal Roadway Lines (LRL):** A set of horizontal lines running parallel to the curb line or edge of pavement that establish a coordinate system for roadway lighting analysis. Refer to [Figure 11B-1.03](#).

**Lumen (lm):** A unit of measure of luminous flux or flow of light from a light source. One lumen is the luminous flux emitted within a unit solid angle (one steradian) by a point source having a uniform luminous intensity of one candela. Refer to Figure 11A-1.01.

**Luminaire:** A complete lighting assembly consisting of a lamp or lamps together with the parts designed to distribute the light, to position and protect the lamps, and to connect the lamps to the power supply.

**Luminaire Dirt Depreciation Curves (LDD):** These curves give information on the relationship of light output depreciation due to accumulated dirt on the luminaire and lamp optical surfaces. An estimate of the dirt level present in the environment is needed to apply the curves. Refer to [Figure 11B-1.02](#).

**Luminance (L):** The luminous intensity of a surface in a given direction per unit of projected area of the surface as viewed from that direction (measured in foot-lamberts).

**Lux (lx):** The International System (SI) unit of illumination. One lux is the illumination incident on a surface one square meter in area on which there is uniformly distributed a luminous flux of one lumen. One lux equals .0929 footcandle.

**Maintenance Factor (MF):** A depreciation factor that is the product of the Lamp Lumen Depreciation Factor (LLD) and the Luminaire Dirt Depreciation Factor (LDD). This factor is applied to the initial average footcandles to account for dirt accumulation and lamp depreciation at some predetermined point after installation.

**Mean Lamp Lumens:** Average quantity of light output (lumens) over the life of the lamp. High pressure sodium, LED, and incandescent lamps are measured for mean lumens at 50% of lamp life. Fluorescent and metal halide lamps are measured for mean lumens at 40% of rated lamp life.

**Mounting Height (MH):** The vertical distance between the roadway surface and the center of the apparent light source of the luminaire (fixture elevation relative to the roadway surface).

**Nadir:** A point directly below an observer or object. In lighting, the point vertically below a luminaire's lamp source center with the luminaire mounted in standard position with zero tilt or roll. Refer to [Figure 11B-1.05](#).

**Overhang:** The transverse horizontal dimension of the position of the luminaire relative to the edge of the roadway or back of curb of the street. Positive overhang is in the direction toward the street center. Negative overhang is in the direction away from the street center.

**Roadway Width:** The curb to curb width for urban roadway sections and edge to edge pavement width for rural roadway sections.

**Steradian:** The unit measure of solid angle defined as the conical or pyramid shape that subtends an area on a sphere surface equal to the radius squared. Refer to Figure 11A-1.01.

**Spacing:** The distance between successive lighting units measured longitudinally along the centerline of the roadway.

**Transverse Roadway Lines (TRL):** A set of horizontal lines running perpendicular to the curb line or edge of pavement that establish a coordinate system for roadway lighting analysis. Refer to [Figure 11B-1.03](#).

**Vertical Footcandle:** One lumen distributed uniformly over a vertical surface one square foot in area. Thus, vertical footcandle is a measure of illumination from light that strikes a vertical surface such as curbs, piers, retaining walls, or other objects with a vertical surface.

**Watt:** The measure of power or the rate of flow of energy per time. One watt equals the flow of one joule of energy per second. Watts are also equivalent to volts multiplied by amps.

**Figure 11A-1.01: Lighting Units Definition Diagram**

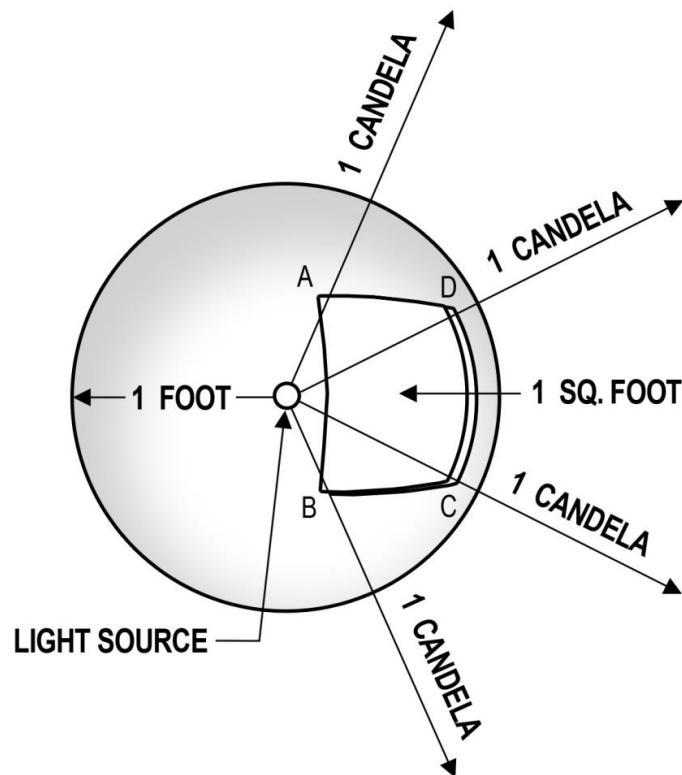

Relationship between candelas, lumens, and footcandles: A uniform point source (luminous intensity or candlepower equal to one candela) is shown at the center of a sphere of unit radius whose interior surface has a reflectance of zero. The illuminance at any point on the sphere is one footcandle (one lumen per square foot) when the radius is one foot. The solid angle subtended by the area A,B,C,D is one steradian. The flux density is therefore one lumen per steradian, which corresponds to a luminous intensity of one candela as originally assumed. The sphere has a total area of  $4\pi$  (or 12.57) square feet and there is a luminous flux of one lumen falling on each unit area. Thus, the source provides a total of 12.57 lumens.

Source: Adapted from *ANSI / IES RP-8-00 (R2005)*

## E. References

Illuminating Engineering Society *Roadway Lighting*. ANSI / IES RP-8-14.

Iowa Administrative Codes, 2018.



# Luminaires

## A. Lighting Sources

Since the development of street lighting, there have been many electrical lighting source types used to illuminate public streets, the first being the incandescent lamp. Other lamp types developed over time were fluorescent, and high intensity discharge (HID) types such as mercury vapor, metal halide (MH), low pressure sodium, and high pressure sodium (HPS). Most recently, the solid state light emitting diode (LED) has become the choice because of its efficiency to create and apply light in street applications. Because of the enactment of the Iowa Code in 1989 mandating outdoor lighting efficiency, the Code revisions in 2010, and other application considerations, the most practical choices today are LED, HPS, and MH. For a comparison of these source types, refer to Table 11B-1.01.

**Table 11B-1.01: Typical Street Lighting Performance Values**

Lamp Type and Wattage	Initial Lamp Lumens	Lamp Efficacy (l/w)	Lamp and Ballast Watts	Lamp and Ballast Efficacy (l/w)	Luminaire Optical Efficiency (%)	Overall System Efficacy (l/w)	Average Life (hrs)
133W Light Emitting Diode (LED)	16,400	123	133	123	--	123	>100,000
250W High Pressure Sodium (HPS)	28,000	112	295	95	85	80.7	24,000
250W Metal Halide (MH)	21,500	86	285	75.5	85	64.2	20,000

For HPS and MH, the performance of the light source will vary with wattage size. Typically, the larger the size, the better the efficacy or lumens per watt of the lamp. This is not the case for LED luminaires. Since an LED light assembly is comprised of multiple small LED lamps each having the same efficacy and larger LED luminaires just contain more of the same individual lamps, the efficacy ratio tends to remain the same over the luminaire size range.

For comparison purposes, the table contains a 133 watt LED, a 250 watt HPS lamp, and a 250 watt MH lamp luminaire. The 133 watt LED size was chosen based on application experience. This LED luminaire puts out less total lumens than either of the other two, but because of superior optical efficiency and control, this size luminaire will produce similar street illumination results as a 250W HPS luminaire.

The efficacy ratio suffers as all of the luminaire losses are considered. For the HPS and MH cases, the initial efficacy is based on the lamp input wattage. The efficacy ratio drops when the ballast wattage is included in the calculation. The efficacy ratio drops again when the inherent lumen losses of the luminaire optics are considered. LEDs are rated differently. The initial lumen output is that measured from the entire luminaire assembly at the outset. Therefore, this value has already considered the lamp intensity and any luminaire optical losses. Only the driver wattage needs to be included to arrive at the overall system efficacy.

Another comparison is that LEDs are projected to last significantly longer than HPS or MH. The >100,000 hour life equates to over 22 years for a street light averaging 12 hours of burn time per night. At this time, LED lighting has not been in practical application for this long. Manufacturers base the rated life on projections from laboratory testing. Due to longer life, LED lighting has the potential for significant maintenance savings.

LED luminaires offer the ability to select the color emanating. Typical LED street lighting is using a white light of around 4,000 degrees Kelvin (3,500 to 4,500 degrees). LED luminaires have the option of providing a light similar to those of HPS luminaires (orange tone, around 3,000 degrees Kelvin) or more of a bluish tone (around 5,000 to 6,000 degrees Kelvin).

When replacing existing HPS luminaires with LED, Table 11B-1.02 shows approximate comparable LED luminaire lumen output to HPS wattages.

**Table 11B-1.02:** LED Lumen Equivalency to HPS Wattage

HPS Wattage	LED Lumen Equivalent	
	Low	High
70	2,500	3,500
100	3,500	6,000
150	6,000	9,000
250	13,000	18,000
400	23,000	28,000

## B. Light System Depreciation

Lighting system depreciation is the loss or degradation of the light output of a luminaire over time with the same power input. The primary factors of lighting system depreciation are lamp lumen depreciation (LLD) and luminaire dirt depreciation (LDD). The light source types considered in this chapter suffer degradation of their light output over their lifetime. A typical range for LLD is from 0.9 to 0.78.

All luminaire assemblies are susceptible to dirt ingress, which absorbs/blocks/disperses light produced by the lamp and prevents it from reaching the intended destination. Some judgment is required to evaluate the luminaire enclosure for contamination protection and the environment to which the luminaire will be exposed. A typical range for LDD is 0.95 to 0.78.

The product of these two factors is referred to as the Maintenance Factor (MF). This factor multiplied by the initial light source lumen output gives the maintained lumen output value, which is the expected performance of the lighting system near the end of its rated life. The maintained lumens value is what is used in lighting design photometric calculations. Typical maintenance factors used are:

High Pressure Sodium:	0.70 to 0.80
Metal Halide:	0.70 to 0.78
LED:	0.80 to 0.85

Figures 11B-1.01 and 11B-1.02 depict lamp lumen and dirt depreciation curves.

Figure 11B-1.01: Typical Lamp Lumen Depreciation

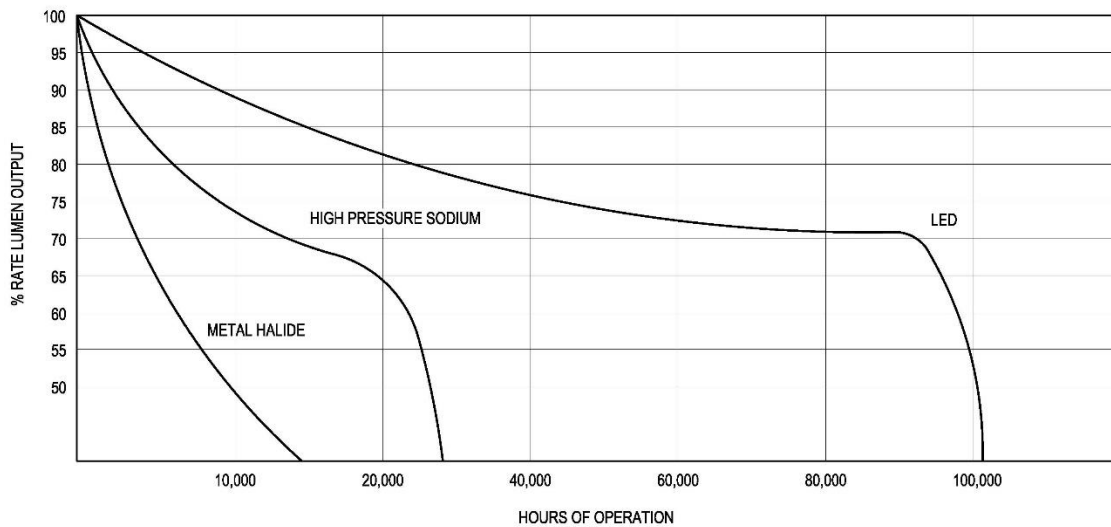
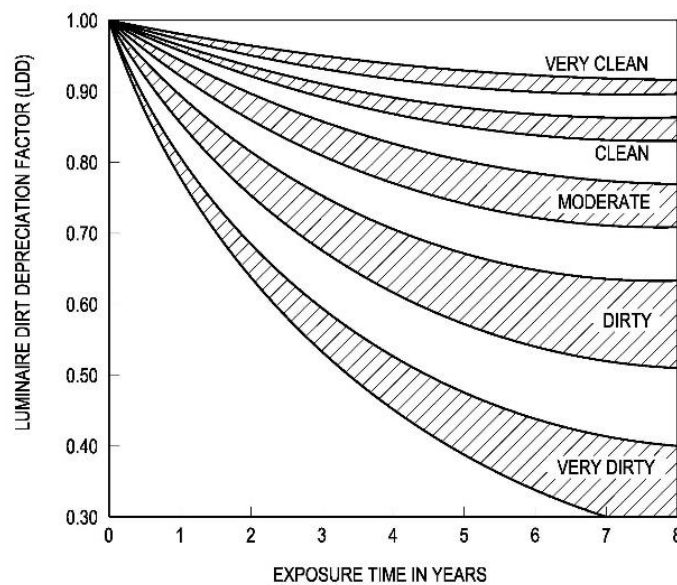

Figure 11B-1.02: Typical Luminaire Dirt Depreciation



Select the appropriate curve according to the type of ambient conditions as described by the following examples:

- Very Clean - No nearby smoke or dust generating activities and a low ambient contaminant level. Light traffic. Generally limited to residential or rural areas. The ambient particulate level is no more than 150 micrograms per cubic meter.
- Clean - No nearby smoke or dust generating activities. Moderate to heavy traffic. The ambient particulate level is no more than 300 micrograms per cubic meter.
- Moderate - Moderate smoke or dust generating activities nearby. The ambient particulate level is no more than 600 micrograms per cubic meter.
- Dirty - Smoke or dust plumes generated by nearby activities may occasionally envelope the luminaires.
- Very Dirty - As above but the luminaires are commonly enveloped by smoke or dust plumes.

Source: Adapted from *Roadway Lighting Handbook*

## C. Luminaire Light Distribution Classifications

The Illuminating Engineering Society (IES) has developed classification categories and parameters to describe the photometric properties of luminaires. The classifications assist lighting designers in choosing the proper luminaires to accomplish the street lighting task. The categories are lateral light distribution, vertical light distribution, and cutoff rating.

- 1. Lateral Light Distribution:** The lateral light distribution classification describes where the light from a luminaire falls into the street surface in relation to the street width, or in other words, how far the light reaches or lands across the street. The classification rating depends on the lateral distance, measured in multiples of luminaire mounting height (mh), where the half-maximum candela trace lands in relation to the location of the luminaire. Refer to Figure 11B-1.03.

Following are the IES lateral distribution types and their definitions:

Type I: Half-maximum candela trace falls between 1 mh on the house side and 1mh on the street side of the luminaire position.

Type II: Trace falls between 1 mh and 1.75 mh on the street side of the luminaire position.

Type III: Trace falls between 1.75 mh and 2.75 mh on the street side of the luminaire position.

Type IV: Trace falls beyond 2.75 mh on the street side of the luminaire position.

Type V: Has distribution that is circularly symmetrical around the luminaire position.

The most popular types used for public streets and roads are Types II, III, and IV. Type V distribution is more popularly used in parking or area lighting applications. Type I distribution is used when the luminaire is positioned in the center median of a narrow roadway such as a boulevard driveway.

- 2. Vertical Light Distribution:** The vertical light distribution describes where the maximum light intensity (maximum candela) falls longitudinally up and down the street measured in multiples of mounting height in relation to the location of the luminaire (refer to Figure 11B-1.03). Following are the IES vertical distribution types and their definitions:

Very Short: The maximum intensity point lands 0 to 1.0 mh each way longitudinally from the luminaire position.

Short: The maximum intensity point lands between 1.0 mh and 2.25 mh each way longitudinally from the luminaire position.

Medium: The maximum intensity point lands between 2.25 mh and 3.75 mh each way longitudinally from the luminaire position.

Long: The maximum intensity point lands between 3.75 mh and 6.0 mh each way longitudinally from the luminaire position.

Very Long: The maximum intensity point lands beyond 6.0 mh each way longitudinally from the luminaire position.

On the basis of vertical light distribution, the theoretical maximum spacing for a vertical distribution type is such that the maximum candlepower beams from adjacent luminaires are joined on the roadway surface. With this assumption, the maximum luminaire spacing for each distribution type is:

Very Short: 2.0 mounting heights

Short: 4.5 mounting heights

Medium: 7.5 mounting heights

Long: 12.0 mounting heights

Very Long: Beyond 12.0 mounting heights

From a practical standpoint, the medium distribution is predominantly used in practice, and the spacing of luminaires normally does not exceed five to six mounting heights. Short distributions are not used extensively for reasons of economy, because extremely short spacing and more lighting assemblies are required. At the other extreme, the long distributions are not used to any great extent because the high beam angle of maximum candlepower often produces excessive glare, as further described by the cutoff or backlight, uplight, and glare (BUG) rating of a luminaire.

Figure 11B-1.03: IES Light Distribution - Illumination Zone Grid

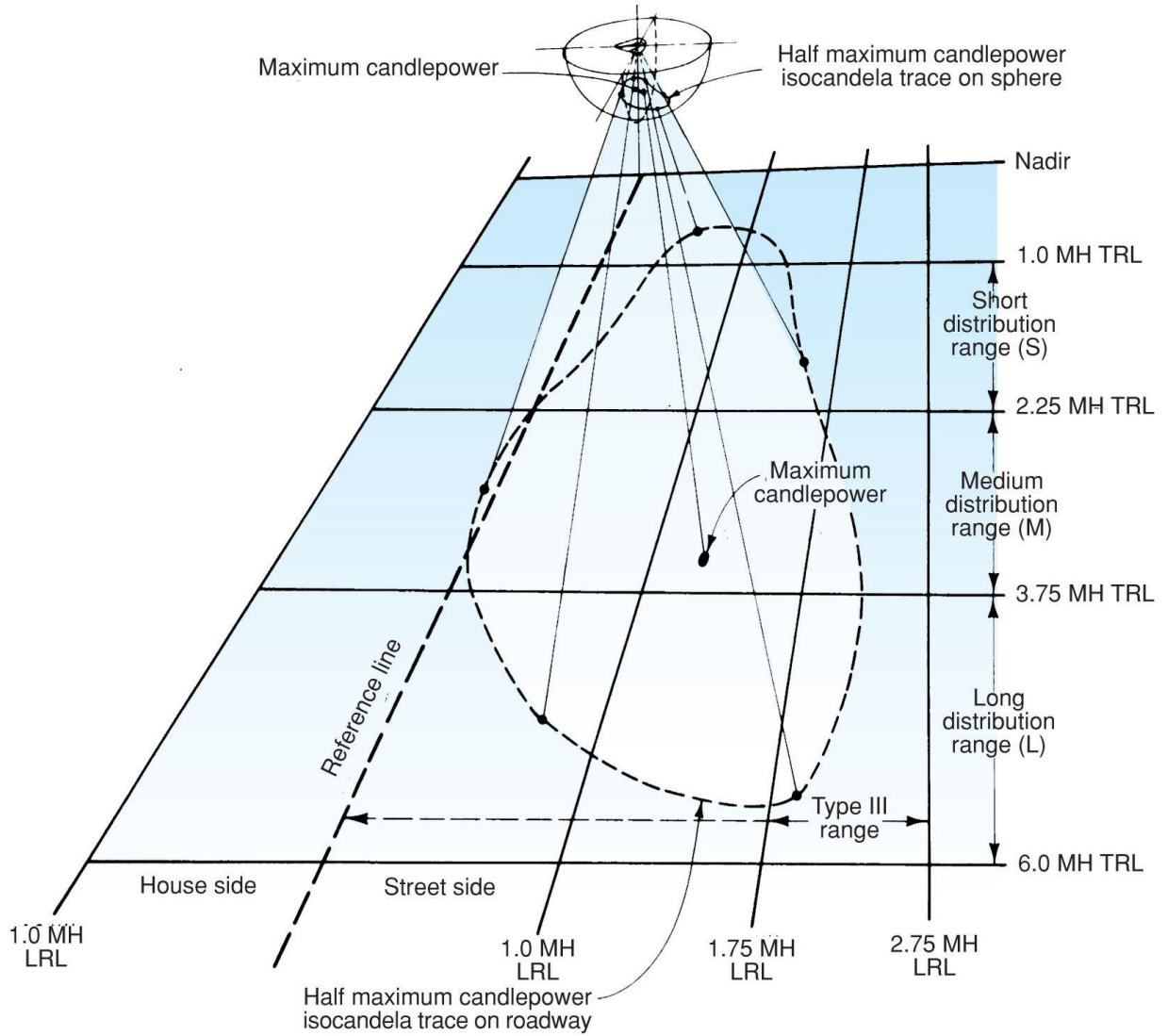

Source: IES Lighting Handbook

Table 11B-1.02: IES Distribution Summary Diagrams

IES Distribution Type	Longitudinal Classification		
	Short "S"	Medium "M"	Long "L"
	Maximum Spacing Is 4.5 Times Mounting Height	Maximum Spacing Is 7.5 Times Mounting Height	Maximum Spacing Is 12.0 Times Mounting Height
Type I For Streets Up to 2.0 Times Mounting Height in Width			
Type II For Streets Up To 1.75 Times Mounting Height in Width			
Type III For Streets Up To 2.75 Times Mounting Height In Width			
Type IV For Streets Up to 2.75 Times Mounting Height In Width			
Type V For General Area Lighting			

**3. Cutoff Rating:** Disability and discomfort glare are largely a result of light emission into the driver's eye. This is largely caused by high-angle light (zone between 80 degrees to 90 degrees above nadir) emanating from a luminaire. Refer to Figure 11B-1.04. Also a concern is the amount of light emanating from the luminaire above 90 degrees from nadir (horizontal plane at the luminaire). This light contributes to sky glow. If BUG ratings are not available, it is necessary that luminaires be classified according to their relative glare effects. Thus, luminaires are classified by IES as follows:

**Full Cutoff:** A luminaire light distribution is classified as full cutoff when the luminous intensity (candela) at or above 90 degrees from nadir is zero, and the candela per 1,000 bare lamp lumens does not exceed 100 (10%) at or above a vertical angle of 80 degrees above nadir. This applies to all lateral angles around the luminaire.

**Cutoff:** A luminaire light distribution is classified as cutoff when the luminous intensity (candela) per 1,000 bare lamp lumens does not exceed 25 (2.5%) at or above 90 degrees from nadir, and does not exceed 100 (10%) at or above a vertical angle of 80 degrees above nadir. This applies to all lateral angles around the luminaire.

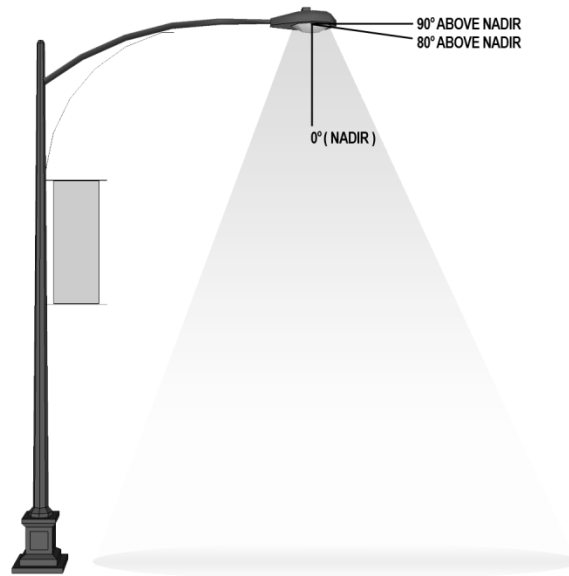
**Figure 11B-1.04:** Luminaire Cutoff Diagram

**Semicutoff:** A luminaire light distribution is classified as semicutoff when the luminous intensity (candela) per 1,000 bare lamp lumens does not exceed 50 (5%) at or above 90 degrees from nadir, and does not exceed 200 (10%) at or above a vertical angle of 80 degrees above nadir. This applies to all lateral angles around the luminaire.

**Noncutoff:** A luminaire light distribution where there is no candela limitation in the zone above maximum candela.

As noted above, the metrics related to cutoff classifications for High Intensity Discharge (HID) products are based on candela (intensity) values at specific vertical angles of 80 and 90 degrees when expressed as a percentage of “rated lamp lumens”. If LED fixtures are to be evaluated, a problem is developed because LED fixtures are rated in absolute format where there is no lumen rating. This difference can lead to problems if LED luminaires are compared to HID luminaires.

In order to address this difference, the IESNA has published TM-15-11, which uses the parameters of BUG to determine the lumen distributions in specific areas. Design software programs are available that use the BUG rating system. Designers should consult the updated Appendix A of the TM-15-11 document if their design evaluation includes both HID and LED fixtures so the proper comparisons can be made.



- 4. Backlight, Uplight, and Glare (BUG) Rating:** Previous editions of the IES RP-8 included cutoff classifications that have become well known. However, those classifications did not fully describe the light emanating from a fixture. In 2011, IES published TM-15-11, Luminaire Classification for Outdoor Luminaires, which describes the Luminaire Classification System (LCS). This system evaluates fixtures for the amount of light emanating in all directions to include potential nuisance lighting, including backlight, uplight, and forward light (see Figure 11B-1.04). LCS describes the amount of light in each of these three primary angles to classify each fixture by the BUG rating. The lumen output from each fixture is measured at various angles from the fixture to describe overall light distribution. The number of lumens at the various angles are compared to the maximum number of lumens allowable on tables established within the TM-15-11. The following describes the BUG rating in more detail:

- Backlight:** Backlight describes the lumen distribution away from the street (house side). A B0 rating requires less than 110 or 220 lumens directed behind the luminaire/pole depending on the angle. A B0 or B1 rating may require a shield or optic limiter to block light emanating towards private property for typical street light fixtures. Typical rating for a LED luminaire equivalent to a 250 watt HPS fixture would be B3.
- Uplight:** Uplight describes the lumen distribution emanating above the horizontal plane at a luminaire. U0 rating requires zero lumens directed above the luminaire. Most typical LED street luminaires achieve this U0 rating independent of the number of total lumens from the luminaire. Decorative fixtures could emit lumens above horizontal and have a U rating higher than zero.
- Glare:** Glare describes the lumen distribution emanating at a high angle below the horizontal plane of the luminaire. This is the visual light that will cause discomfort to drivers. Typical rating for a LED luminaire equivalent to a 250 watt HPS fixture would be G3.

Use caution when specifying the use of dark-sky or night-sky compliant LED luminaires. The International Dark-Sky Association (IDA) has recommendations and has approved luminaires as dark-sky friendly. Those luminaires do include no uplight (U0), but also include an orange tone (similar to HPS, 3,000 degree Kelvin) to minimize reflected blue light from pavement surface.

**Figure 11B-1.05:** Three primary angles of LCS

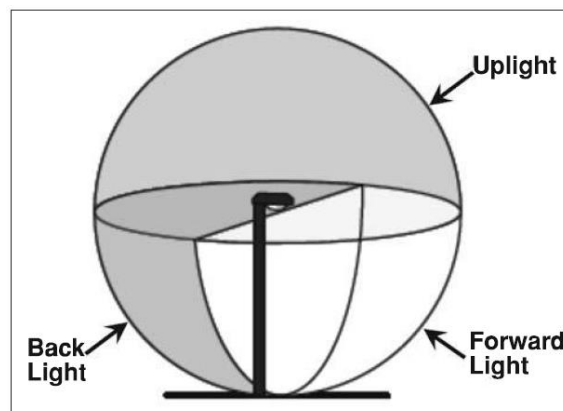

Source: IES TM-15-11

## D. References

Federal Highway Administration. *Roadway Lighting Handbook*. 1978.

Illuminating Engineering Society (IES). *IES Lighting Handbook*. 9<sup>th</sup> Edition.

Illuminating Engineering Society (IES). *Luminaire Classification System for Outdoor Luminaires*. TM-15-11.

---

# LED Lighting

---

## A. LED vs. HPS Lighting

The predominant light source type for city street lighting has been high pressure sodium (HPS) for many years. In fact, HPS type street lighting has been mandated by Iowa Code (with some exceptions) since 1989 as the first choice standard for energy efficient street lighting. Other light source types were allowed to be used if they were shown to have equal or better energy efficiency than HPS.

Prior to the fall of 2010, the efficiency comparison test was based on bare lamp efficacy defined by the Code as lamp output lumens divided by lamp input watts. This efficiency definition did not take into account ballast energy losses or the luminaire's optical efficiency. The only possible practical choices for street lighting luminaires during this time were high intensity discharge (HID) type light sources (high pressure sodium, metal halide, mercury vapor). Since these luminaire types are constructed and essentially produce and control light the same way, the bare lamp efficacy test produced an apples-to-apples comparison. Of these, HPS always had the highest lamp efficacy and by Code is the only source allowed.

Not all of the light produced by the lamp exits the luminaire. HID luminaires generally are about 70% to 85% efficient at allowing the light produced by the lamp out of the luminaire. Also, not all of the light emanating from the luminaire illuminates the desired subject. A significant quantity of the light produced lands directly below the luminaire creating a "hot spot" resulting in excess illumination and wasted light. Also depending on the optics of the luminaire, some of the light is directed above 90 degrees from nadir, which results in fugitive light and undesirably brightens the sky at night.

With the advent of LED lighting, this lighting source type has challenged HPS as the most efficient. However, LED lighting was not immediately recognized as more efficient because LED luminaire efficacy is measured differently, and because of the method of comparison defined in the Iowa Code, LED luminaires were not legal to use for city street lighting. As a result, the Iowa Code was modified to allow their use if it can be shown that they are more energy efficient than HPS fixtures; see [Section 11A-1.C](#). This process involves the regulated street lighting utility obtaining approval from the Iowa Utilities Board. This approval process does not apply for city owned street lights.

LED luminaires are constructed and deliver light differently than HID luminaires. A typical HID street lighting luminaire consists of a single lamp light source surrounded by an optical reflector and optical lens refractor to bounce and/or bend the light from the lamp and direct it onto the street as evenly as possible. The lamp is not necessarily manufactured by the luminaire manufacturer, but the lamp sizes and wattages are standardized throughout the industry. The lamp efficacy of a 250W HPS from one manufacturer is very nearly the same as that from another manufacturer. The same is true for the efficiency of the ballasts.

LED luminaires are constructed using many individual LED lamps assembled into an array and are energized by an on-board power supply commonly called a driver. Luminaires may contain as few as ten or as many as 100 or more LEDs depending on the intended function of the luminaire. The LEDs are typically individually aimed to produce the desired overall illumination pattern. Therefore, the optical control of the light from an LED luminaire is much more precise. For a street lighting application, more lamps are aimed longitudinally up and down the street and less directly below the luminaire. This results in much greater illumination uniformity on the street with less light production as compared to HPS luminaires. It significantly reduces the wasteful “hot spot” directly below the luminaire. The optical efficiency of LED luminaires is about 90% to 95% compared to the 70% to 85% stated above for HID luminaires.

Since the LEDs and the luminaire are an integral assembly, the concept of bare lamp lumens and lamp lumen efficacy is much less meaningful for LED lights. Instead, the lighting industry has chosen absolute lumens as the accepted measure of light output. The parameter of absolute lumens is defined as the measure of the total luminous flux emanating from a luminaire assembly (using any light source, not just LED). This measurement therefore takes into account both the light source and the luminaire assembly efficiency and gives you the total useable light output. It does not describe which way the light is going or whether the light intensity is concentrated in a particular direction or evenly distributed. Dividing the absolute lumens value by the luminaire assembly total input watts gives the luminaire efficacy rating. This is a much more accurate description of the overall efficiency of a luminaire and its ability to convert electrical power into useable light, and takes into account all of the parasitic losses inherent in a luminaire assembly (lamp power-to-light conversion, ballast or driver efficiency, and luminaire optical efficiency).

The ultimate comparison between luminaires is found in their application to a given task and the ability to produce the target illumination (footcandles) and uniformity using the least amount of energy for the application. Currently HPS luminaires still have higher efficacy ratings than do LED luminaires. However, since LED luminaires possess superior optical light control and produce less waste light, street lighting applications using LED lighting typically consume less energy compared to using HPS lighting.

The parameter more popularly being used to compare overall application is watts per average delivered footcandles of illumination. For a given project area, divide the total power draw in watts for the project area by the calculated average footcandles of illumination. This is a better method of comparing the energy efficiency of different lighting systems based on the delivered illumination on a surface rather than just the production of light.

## **B. LED Lighting Advantages**

Besides reduction in energy consumption, there are other advantages to using LED lighting over HPS.

1. Compared to HPS luminaires with the same photometric classification, the application of LED luminaires to achieve a given set of illumination criteria may result in one or more of the following:
  - Better uniformity ratio at the target average illumination level
  - Lower mounting heights resulting in less costly lighting structures
  - Greater spacing between luminaires resulting fewer lighting structures and luminaires
2. The light produced by LEDs is whiter and provides significantly better color rendering of objects. There are studies demonstrating that whiter light improves the visual ability of the human eye. There are discussions among the lighting professionals that lower illumination levels may be acceptable and provide equal visibility using the whiter light of LEDs (or metal halide) as compared to the more yellow light of HPS.

3. The rated service life of LED lighting is projected to be from 50,000 to as much as 100,000 burn-time hours, which is considerably longer than HPS or other lighting types. HPS lighting sources typically have a rated service life of 24,000 burn-time hours. This would significantly reduce street light maintenance costs.
4. The components of LED solid state lighting are recyclable and contain less toxic heavy metal elements.
5. LED luminaires are dimmable. For example, this would allow a street lighting installation serving a business district to illuminate the street at a higher illumination level during evening business hours and dim to a lower allowed minimum illumination level after business hours, which would conserve energy.
6. LED luminaires are instant-on. This feature lends them to the use of occupancy or motion sensor controls to save energy. While this may not be practical for street lighting applications, it could have potential use in parking lot applications.

### **C. LED Lighting Disadvantages**

1. Currently LED luminaires cost more than HPS luminaires.
2. LEDs themselves do not tolerate heat and need to be kept cool during operation. However, luminaire assemblies with good thermal management design can sufficiently control diode junction temperature making LED lighting a practical choice. This issue is partially mitigated by the lower ambient temperature conditions of nighttime operation.
3. Since LED luminaire wattages are not standardized, they do not readily fit into electric utility tariff rate programs and have not been incorporated into utility-owned street lighting stock.



---

## Facility Design

---

### A. General

The basic goal of street lighting is to provide patterns and levels of pavement luminance to provide a safer night driving environment and reduce conflict between motorists and pedestrians. A driver's eye discerns an object on or near the street due to contrast between the brightness of the object and the brightness of the background or pavement, or by means of surface detail, glint, shadows, or detection of motion.

LED lighting provides “smart” capabilities such as the ability to monitor power consumption, remote ability to turn fixtures on/off, pre-programming and remote control of dimming, among others. Another term for those capabilities is “adaptive lighting.” That is the term used in IES-RP-8-14. Although the new technology is available, designers should be aware that problems can result as is the case with all new applications. The technology could be pre-programmed by the manufacturer or set locally through “smart” controls.

Consideration for dimming of LED street lights is the primary adaptive lighting application. If there are significant reductions in vehicle or pedestrian volumes consistently overnight, the agency may consider dimming of the street lights for that period to save additional dollars. In order to minimize potential liability related to dimming the street lights, it is important for an agency to ensure they establish a formal policy allowing the dimming process. An example might be that the base design for a section of street is to meet the criteria for Arterial (major) street with high pedestrian volumes until midnight and then meet the Collector level with low pedestrian volumes until sunrise or at a designated time. One of the challenges for pre-programmed dimming is the ever moving sunrise time and other elements, such as daylight savings time, since there is not a way to set fixed start/stop times. Fixtures with “smart” controls, depending on the supplier, may have the ability to set fixed times for dimming or at least have more control related to dimming. If an agency contracts with a utility to supply and maintain the street lighting network, performance standards related to a dimming program must be very specifically stated in the contract.

Lighting design is concerned with the selection and location of lighting equipment so as to provide improved visibility and increased safety while making the most efficient use of energy with minimum expenditure for the lighting equipment. There are two basic concepts of lighting design - the luminance concept and the illumination concept.

The luminance concept is based on the premise that visibility is related to the luminance of the pavement compared to the luminance of the objects on the pavement. Calculations to determine the luminance of pavement or objects require the estimation of the reflectivity of varying pavement surfaces and objects within the driver's field of vision. These reflectivity values can be difficult to estimate and can vary widely. The illumination concept, which is almost universally used in the United States, is based on the premise that by providing a given level of illumination and uniformity of distribution, satisfactory visibility can be achieved.

The luminance concept is fairly popular in parts of Europe and is being promoted by lighting professionals in the United States. The ANSI/IES RP-8-14 (RP-8) recommends luminance method for relatively straight roads and streets and illumination method for curved streets and intersections.

The IES DG-21-15, *Design Guide for Residential Street Lighting*, references RP-8-14 and the use of the luminance method. However, most agencies that have lighting codes/requirements utilize illuminance criteria and therefore both methods will be discussed.

## B. Design Process

By definition, lighting design according to the luminance method determines how “bright” or amount of light reflected from the pavement towards the driver (quantity) and the uniformity of that luminance the driver sees (quality). The steps in the design process are as follows:

- Determination of the design illumination and uniformity criteria by assessing the facility to be lighted.
- Selecting the type of light source.
- Selecting light source size and mounting height.
- Selecting luminaire light distribution type.
- Determining luminaire spacing and location.
- Checking for design adequacy.

These steps are arranged in the order in which they are usually encountered in the design process.

- 1. Design Criteria:** The first task of the lighting designer is to research and determine if any requirements (such as ordinances, resolutions, or policies) pertaining to street lighting are in effect in the jurisdiction. Many municipalities have no requirements at all. Some may have adopted a published standard in its entirety or have adopted it with some variations. Others may have developed prescriptive guidelines that, for a given street type, specifically describe the luminaire size and type, specific mounting height, and pole spacing. Still others may have developed a combination of these depending on the street type. Finally, a municipality may have requirements that do not deal directly with the amount of light on the street. Rather, they may simply be lighting limitations such as maximum footcandle levels at property or right-of-way lines to control light trespass, or restrict luminaires that emit light above horizontal to control sky glow or excessive glare.

Some communities may provide specific standards such as street lights at intersections only with the potential of mid-block lighting if the block length exceeds a specific distance, such as 500 feet. In rural areas intersection lighting serves more of a way-finding function so more dispersion of the light is important. Most installations of this type remain high pressure sodium light installations.

The designer’s first obligation is to conform to state codes and jurisdictional requirements, but in the absence of such requirements, it is recommended that the designer follow a nationally recognized written street lighting design standard such as RP-8.

To perform street lighting design, two parameters need to be considered - luminance/illuminance level and uniformity. The amount of luminance at a given point on a street is expressed in candela per square meter ( $\text{cd/m}^2$ ). The amount of illuminance at any given point on a street surface is expressed in footcandles (fc). Since the street lighting is typically not distributed evenly over the pavement surface, both methods are expressed in averages when describing the lighting level over a defined area. This parameter describes the “quantity” of light provided.

While the average amount of luminance/illuminance on the street surface may be satisfactory, the lighting distribution may consist of very high (bright) and very low (dim) localized areas. A driver traveling down a street illuminated in this manner will experience difficulty seeing the street and other objects due to the inability of the eye to rapidly adjust to the varying light



conditions. Therefore, another parameter is needed to describe the evenness or uniformity of the applied lighting. This parameter is known as the uniformity ratio of the lighting distribution and is defined as either the ratio of maximum-to-minimum values or the ratio of the average-to-minimum values over the project area. The most popular choice is the average-to-minimum ratio. This parameter describes the “quality” of the lighting distribution. A ratio of 1:1 represents perfectly uniform distribution. A real-life example of this is moonlight at night from a full moon overhead. The illuminance level of moonlight is approximately 0.5 fc but it is almost perfectly uniform.

The Illuminating Engineering Society (IES) has established acceptable luminance levels and uniformity ratios for various public street types (source ANSI/IES RP-8-14). See Table 11C-1.01. To obtain the recommended average luminance and uniformity ratio for a given street, there are two classifications that need to be determined - the street use and the level of pedestrian conflict associated with the street.

**Table 11C-1.01: Luminance Method - Recommended Values**

Street Classification <sup>1</sup>	Pedestrian Area Classification <sup>2</sup>	Average Luminance $L_{avg}$ (cd/m <sup>2</sup> )	Average Uniformity Ratio $L_{avg}/L_{min}$	Max. Veiling Luminance Ratio $L_{vmax}/L_{avg}$
Arterial	High	1.2	3	0.3
	Medium	0.9	3	0.3
	Low	0.6	3.5	0.3
Collector	High	0.8	3	0.4
	Medium	0.6	3.5	0.4
	Low	0.4	4	0.4
Local	High	0.6	6	0.4
	Medium	0.5	6	0.4
	Low	0.3	6	0.4

<sup>1</sup> See Table 11C-1.02

<sup>2</sup> See Table 11C-1.03

**Table 11C-1.02: Street Surface Classifications**

Class	$Q_o$ *	Description	Mode of Reflectance
R1	0.10	PCC street surface. Asphalt street surface with a minimum of 12% of the aggregates composed of artificial brightener (e.g., Synopal) aggregates (e.g., labradorite, quartzite).	Mostly diffuse
R2	0.07	Asphalt street surface with an aggregate composed of minimum 60 percent gravel [size greater than 1 cm (0.4 in.)]. Asphalt street surface with 10% to 15% artificial brightener in aggregate mix. (Not normally used in North America).	Mixed (diffuse and specular)
R3	0.07	Asphalt street surface (regular and carpet seal) with dark aggregates (e.g., trap rock, blast furnace slag); rough texture after some months of use (typical highways).	Slightly specular

\*  $Q_o$  = representative mean luminance coefficient

Source: ANSI / IES RP-8-00 (R2014)

**Table 11C-1.03:** Pedestrian Conflict Area Classifications

High	Areas with significant numbers of pedestrians expected to be on the sidewalks or crossing the streets during darkness. Examples are downtown retail areas, near theaters, concert halls, stadiums, and transit terminals.
Medium	Areas where lesser numbers of pedestrians utilize the streets at night. Typical are downtown office areas, blocks with libraries, apartments, neighborhood shopping, industrial, older city areas, and streets with transit lines.
Low	Areas with very low volumes of night pedestrian usage. These can occur in any of the cited street classifications but may be typified by suburban single family streets, very low density residential developments, and rural or semi-rural areas.

**Table 11C-1.04:** Illuminance Method - Recommended Values

Street and Pedestrian Conflict Area		Pavement Classification (Minimum Maintained Average Values)		Uniformity Ratio $E_{ave}/E_{min}$	Veiling Luminance Ratio $L_{max}/L_{avg}$
Street	Pedestrian Conflict Area	R1 fc	R2 and R3 fc		
Major (Arterial)	High	1.2	1.8	3.0	0.3
	Medium	0.9	1.3	3.0	0.3
	Low	0.6	0.9	3.5	0.3
Collector	High	0.8	1.2	3.0	0.4
	Medium	0.6	0.9	3.5	0.4
	Low	0.4	0.6	4.0	0.4
Local	High	0.6	0.9	6.0	0.4
	Medium	0.5	0.7	6.0	0.4
	Low	0.3	0.4	6.0	0.4

<sup>1</sup> See Table 11C-1.02

<sup>2</sup> See Table 11C-1.03

Source: Adapted from ANSI / IES RP-8-14

IES removed the recommended average illuminance and uniformity ratio for various public street types in the latest RP-8. However RP-8 states that for curved roadways and streets, the illuminance method should be used. An equivalent amount of luminance should be generated by incorporating a ratio of  $1 \text{ cd/m}^2 \approx 15 \text{ lux}$  (1.5 fc) for an R3 pavement and  $1 \text{ cd/m}^2 \approx 10 \text{ lux}$  (1.0 fc) for an R1 pavement. These equivalent illuminance values are in Table 11C-1.04. To obtain the recommended average illuminance and uniformity ratio for a given street, there are three classifications that need to be determined - the street use, the pavement type, and the level of pedestrian conflict associated with the street.

- a. **Street Use:** Some jurisdictions have already classified their streets and it is recommended to follow these classifications first. If the jurisdiction has not established classifications, refer to the descriptions in [Chapter 5 - Roadway Design](#) to determine the classification of the subject street.
- b. **Pavement Type:** Illuminance method only - pavement types are classified into three categories, R1 through R3. For the purposes of determining lighting criteria, two of the pavement classifications, R2 and R3, are combined, forming two illumination classifications. Refer to Table 11C-1.02 to determine the pavement type classification of the subject street.

- c. Pedestrian Conflict:** Pedestrian conflict is categorized into three classifications - high, medium, and low. The level of pedestrian conflict is almost entirely driven by the land use adjoining the street and the potential of the land use to cause pedestrian traffic during nighttime hours. For example, pedestrian conflict would be low for a local residential street as compared to a high pedestrian conflict level for a local street next to a movie theater. Refer to Table 11C-1.03 to determine the potential pedestrian conflict for the subject street.

Using the defined classifications, determine the recommended luminance/illuminance and uniformity ratio for the subject street. Both luminance ( $\text{cd/m}^2$ ) and illuminance ( $\text{fc}$ ) values listed represent average maintained values over the street surface. The uniformity ratio is average value divided by the minimum value. The designer may consider more illumination and/or better uniformity for the street if it would better serve expected activity along the route.

- 2. Selecting the Type of Light Source:** The vast majority of street lighting in municipalities is owned, operated, and maintained by the local electric utility. The cost for the installation, energy, and maintenance is paid for by the municipality in monthly installments based on established utility tariff rates for the type of lighting units installed. These rates are regulated and set by the utility with approval from the Iowa Utilities Board. If the street lighting to be installed on a particular project will be utility owned, the lighting equipment will need to be selected from that available from the utility.

If the street lighting will be owned and operated by the municipality, the installation needs to meet Iowa Code. LED technology has become the standard technology for street lighting over HPS lighting, including in the decorative/historical luminaires.

If initial cost is an important parameter, HPS will have lower installation cost. If life-cycle cost is the deciding factor, then LED will win out, but the designer will have to develop layouts for each type to make the comparison. If the color of the light and color rendering of objects are important, LED will be the choice.

- 3. Selecting Light Source Size and Mounting Height:** The distance the lamp/luminaire is mounted above the street will affect the lighting intensity, uniformity, area covered, and relative glare of the unit. Higher mounted units will provide greater coverage, more uniformity, and reduction of glare, but a lower lighting level. The illumination of an object from a light source varies inversely to the square of the distance from the light source, so doubling the distance will reduce the illumination on the object to one fourth of the original value. Therefore, greater mounting heights will require larger lumen/wattage luminaires. It is necessary to weigh the effects of larger lumen/wattage luminaires against a greater number of smaller units at lower mounting heights with an increase in glare potential.

Mounting heights of street luminaires vary from 15 feet to more than 100 feet above the street surface. Conventional municipal street lighting utilizes mounting heights of 25 to 50 feet. Generally, the greater the target uniformity ratio, the shorter the mounting height and vice versa. Local street lighting uses 25 to 30 feet mounting heights while collector and major streets will use 30 to 40 feet mounting heights. Figure 11C-1.01 shows minimum mounting heights for various maximum candela levels and vertical light distributions.

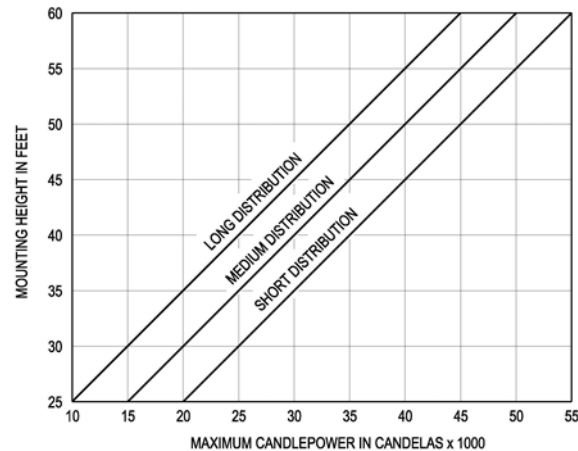
**Figure 11C-1.01:** Minimum Mounting Height vs. Maximum Candela

Source: Adapted from *Roadway Lighting Handbook*

- Selecting Luminaire Light Distribution Type:** Selection of the luminaire light distribution type (lateral, vertical, and BUG rating) for a given street lighting application depends on several elements, the mounting height, the pole placement pattern, the cross sectional geometry of the street, and any jurisdictional ordinances that control or limit light trespass, glare, or sky glow. Again, the options may be limited by the local electrical utility.

[Table 11B-1.02](#) is a guide to selecting which lateral light distribution(s) are best suited for the street width and pole placement pattern. This is only a guide. While lighting distribution types are defined, luminaires that fit into a type still vary between manufacturers. A Type II from one manufacturer may provide better illumination than a Type III from another for a wider street. For the given street width, pole pattern, and mounting height, the distribution pattern from the Type II may “fit” together better and provide more uniform light.

The designer may select the first luminaire that meets the lighting criteria. However this may not be optimum selection based on defined goals of the project. Street lighting design is an iterative process if optimization is to be achieved.

- Determining Luminaire Spacing and Location:** The most common lateral location of street lighting luminaires is positioned over the curb line or edge of pavement (zero overhang). This is also the base line for luminaire design. Since it would be impractical to place light poles directly at the edge of the street, lighting support structures typically consist of a poles fitted with mast arms to set the poles back away from and provide clearance for traffic and pedestrians. Streets typically have defined clear zones behind the curb or pavement edge, the width of which depends on the street characteristics. The designer needs to consider setback to determine if a mastarm of sufficient length is available to place the luminaire at the street edge. Luminaires positioned with excessive negative overhang will likely require shorter longitudinal luminaire spacing to compensate.

[Section 11B-1](#) discusses theoretical maximum longitudinal luminaire/pole spacing for a given vertical light distribution. However, this spacing may not be practical to fit the site. The designer needs to consider how the street interfaces with the adjoining property features. These factors include location of sidewalks, bike trails, driveways, alleys, and cross streets. Many times, particularly in residential areas, it is desirable to place the light poles in line with the side property lines.

6. **Checking for Design Adequacy:** All of the above selected elements are formed into a design concept or model. The next step is to perform calculations to verify the chosen equipment and layout to meet the design criteria. For many years, manual calculations were the only methods used to determine the resulting design illumination and uniformity. Numerous software programs have been developed and are available to automate the calculation process.

a. **Manual Calculation Method:** The most popular manual calculation method is the coefficient of utilization and isofootcandle plot method. As the name implies, two pieces of graphical information are required, a coefficient of utilization curve and an isofootcandle plot. These are developed by luminaire manufacturers and are required for the calculation process. Examples of such are shown in Figure 11C-1.02. The coefficient curve is a quantitative description of the percentage of total lumens emitted from the fixture that will land on or be utilized to illuminate the street below based on the street width and relative position of the luminaire to the street.

**Figure 11C-1.02:** Typical Luminaire Utilization and Isofootcandle Plots

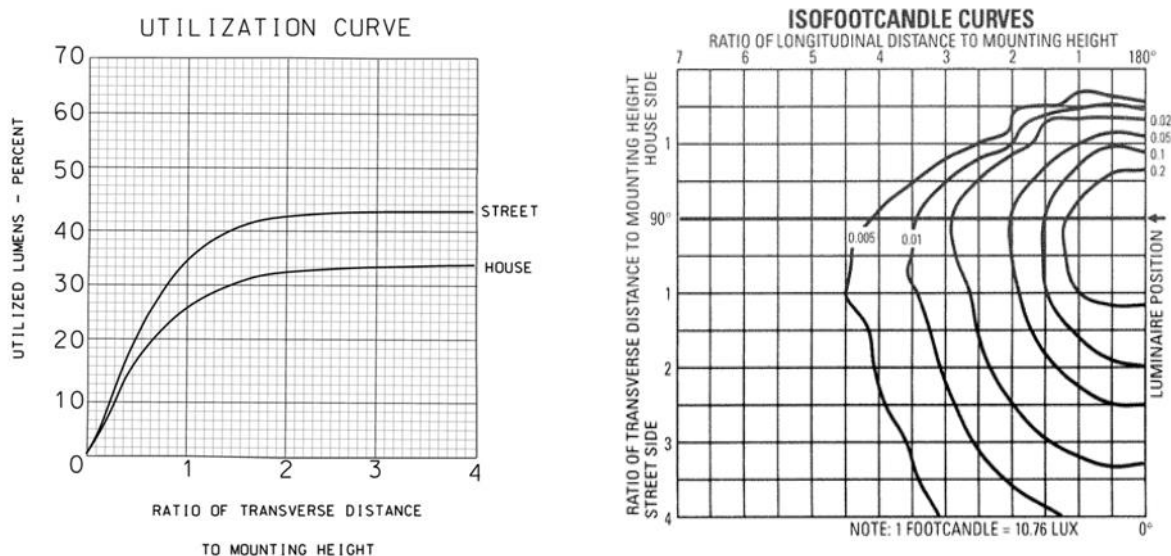

Rather than repeat the process here, the designer is recommended to visit and access [Minnesota DOT Roadway Lighting Design Manual, Chapter 4](#). The discussion in this document provides a good step-by-step description of the manual calculation process.

b. **Computer Modeling Method:** There are numerous programs available, both purchased and free to model lighting installations and perform photometric calculations. Some software packages can be very sophisticated with the ability to create such things as shade plots and shade and shadow renderings to closely represent what the human eye would see. For the design purposes described herein, all that is required of the software is to take luminaire photometric data and perform point-by-point calculations on a defined plane and be able to export the numerical results.

The first requirement is to create a computer model of the street to be lit. For most situations, this involves defining the width and length of the street. Most of the lighting programs have drawing tools to create the model directly in the program. If an electronic representation of the street is available from a computer-aided design file such as that created by AutoCAD or Microstation, this can be imported into the lighting program to form the model. Once this is done, the designer will “place” luminaires spatially above the model surface locating them with the desired mounting height and overhang from the street edge.

For each luminaire type to be considered, the designer needs to acquire a photometric file that describes the photometry or lighting distribution characteristics of the luminaire. These files are generated by the manufacturer through laboratory testing. They are text files containing a defined array of light intensity values (candela) in standardly defined spatial directions emanating from the luminaire. The files are commonly referred to as IES photometric files (or IES files) since the standard was developed by the Illuminating Engineering Society (IES). The files are readily available from the manufacturer's website at no cost.

The files are imported into the program to model the performance of the selected luminaires. The candela values in the file are typically based on a default lamp lumen value of 1,000 lumens. The designer will be required to input the proper initial lamp lumen value, which will scale the intensity values accordingly. For LED luminaires however, the file usually contains the actual initial lumen value of the luminaire assembly since the LEDs are not necessarily a removable modular element of the luminaire. In any case, the designer is cautioned to verify the proper lumen value is used. Also, the designer will need to enter the lumen maintenance factor for each luminaire model.

The final task is to define a calculation area by drawing a region on the street model surface. Confirm with the municipality to determine any potential requirements for defining the calculation area. The width of the area could be back of curb to back of curb for example, or it could be right-of-way to right-of-way to calculate the illumination from building face to building face in a downtown business district. Within this area, the designer will create a calculation grid that is a defined set of points on the surface, at which the lighting level will be calculated. Typical calculation point grids are a 10 feet by 10 feet or a 5 feet by 5 feet rectangular array. More points in the calculating area will usually yield more accurate results but require more computer processing time. For a small area, this is not a problem, but if the designer has created a large area, the time may be significant. The RP-8-14 recommends locating two grid lines per lane, one-quarter of the distance from each lane line. It continues to indicate that points along the gridlines should not be placed further than 5 meters (16 feet) apart and have at least 10 calculation points located between each luminaire. This applies for both luminance and illuminance methods.

The program utilizes the superposition principal to perform the calculation. The program will step through each point and calculate the luminance/illuminance contribution at that point on the model surface from each luminaire defined in the model. Each of these contribution values are simply added together to get the overall illumination at that point. Once all of the points are calculated, the program determines the average value of all of the points in the grid, giving the average luminance or illuminance of the entire surface. The program then uses the point with the lowest value to calculate the average-to-minimum uniformity ratio.

A clear advantage of using computer modeling is the ease in which the designer can make changes to the luminaire layout model and obtain the luminance or illuminance results for different scenarios. For example, the designer could change luminaire, type, wattage, mounting height, or position; or any combination of these to optimize the lighting design and minimize the energy consumption.

Most available lighting design software packages contain pre-defined street models or "wizards" for quick luminaire spacing optimization. This allows a designer to simply input a luminaire at a mounting height, a street width, a mounting pattern (one-side, each side staggered, etc.), and target design criteria, and have the program calculate the optimum longitudinal luminaire spacing.

## **C. References**

Federal Highway Administration. *Roadway Lighting Handbook*. 1978.

Illuminating Engineering Society. *Roadway Lighting*. ANSI / IES RP-8-14.

Illuminating Engineering Society. *Design Guide for Residential Street Lighting*. IES DG-21-15.

Minnesota Department of Transportation. *Roadway Lighting Design Manual*. 2010.

