



Table of Contents

Chapter 14 - Trenchless Construction

14A General Information

14A-1-----General Information
A. Purpose..... 1
B. When to Consider Trenchless Construction..... 1
C. Cost Analysis of Trenchless vs. Open Cut Construction..... 1
D. Definitions..... 1
14A-2-----Commonly Used Trenchless Technologies
A. Techniques Common in the United States..... 1
B. Techniques Common in Iowa..... 1

14B New Construction

14B-1-----Planning a Bore
A. Bore Pit Locations..... 1
B. Manhole Locations..... 1
C. Bore Lengths..... 1
D. Acceptable Tolerances..... 1
E. Information to Provide to Contractor..... 2
F. Risk Allocation..... 2
G. Drawing on Contractor’s Expertise..... 3
14B-2-----Methods of New Construction
A. Trenchless Methods for New Construction..... 1
B. Expected Service Life for New Construction..... 1
C. Auger Boring..... 1
D. Compaction Boring..... 3
E. Pipe Ramming..... 5
F. Slurry Methods..... 7
G. Horizontal Directional Drilling..... 8
H. Pipe Jacking and Utility Tunneling..... 11
I. Microtunneling..... 14

14C Rehabilitation

14C-1-----Evaluation of Existing Conditions for Rehabilitation
A. Introduction..... 1
B. Evaluating the Condition of the Existing System..... 1
C. Selection of a Rehabilitation Technique..... 2

14C Rehabilitation (Continued)

14C-2-----Pipeline Rehabilitation

- A. Cured-in-place Pipe (CIPP)..... 1
- B. Fold-and-formed Pipe (FFP) and Deformed Reformed Pipe (DRP) Lining..... 13
- C. Sliplining..... 14
- D. Pipe Bursting..... 16

14C-3-----Manhole Rehabilitation

- A. Introduction.....1
- B. Corrosion Resistant Chimney Sealant..... 1
- C. Centrifugally Cast Mortar..... 1
- D. In-situ Manhole Replacement.....3

14D References

14D-1-----References

General Information

A. Purpose

The purpose of this chapter is to discuss the various trenchless methods of construction and rehabilitation. This chapter does not describe each trenchless method in great detail; rather, it provides the designer with a general description of the various construction methods available and the applications and limitations of each method. The goal of this chapter is to educate the designer to recognize situations where a trenchless construction method may be preferred over open cut construction.

B. When to Consider Trenchless Construction

There are many situations where trenchless construction is preferable to open cut construction. The most common are for road, railroad, and river crossings. However, other situations may be suitable for trenchless construction, such as avoiding possible damage to adjacent structures, homes, and businesses caused by dewatering operations; installations in tight corridors; and minimizing disturbances in environmentally sensitive areas.

C. Cost Analysis of Trenchless vs. Open Cut Construction

Most trenchless construction methods have a higher dollar cost than that of their open cut counterparts. However, one needs to consider the benefits that trenchless construction provides and weigh all of the costs before deciding against using a trenchless technique. It is easy to determine the cost of the tangible work items that trenchless construction avoids, such as pavement removal and replacement, dewatering, surface restoration, right-of-way, or utility easement acquisition. However, the benefits of trenchless construction go well beyond these items and include avoiding public inconvenience and lost business revenue caused by a closed roadway; minimizing utility conflicts; reducing dust, erosion, vibration, tree removal, and other environmental impacts; eliminating danger to workers and the public posed by an open trench; and reducing the potential damage to adjacent structures caused by large scale dewatering operations. Unfortunately, it is difficult to assign a dollar value to these potential situations.

D. Definitions

Annular Space: Free space between the existing pipe and any lining.

Auger Boring: (*See also guided auger boring*) A technique for forming a bore from a drive pit to a reception pit, by means of a rotating cutting head. Spoil is removed back to the drive shaft by helically wound auger flights rotating in a steel casing. The equipment may have limited steering capability.

Back Reamer: A cutting head attached to the leading end of a drill string to enlarge the pilot bore during a pull-back operation to enable the carrier or sleeve or casing to be installed in.

Bent Sub: An offset section of drill stem close behind the drill head that allows steering corrections to be made by rotation of the drill string to orientate the cutting head. Frequently used in directional drilling.

Bentonite: (*See also drilling fluid*) A colloidal clay sold under various trade names that forms a slick slurry or gel when water is added. Also known as drillers mud.

Boring: (1) The dislodging or displacement of spoil by a rotating auger or drill string to produce a hole called a bore. (2) An earth-drilling process used for installing conduits or pipelines. (3) Obtaining soil samples for evaluation and testing.

Boring Pit: An excavation in the earth of specified length and width for placing the machine on line and grade.

Butt Fusion Weld: A method of joining polyethylene pipe where two pipe ends are rapidly brought together under pressure to form a homogeneous bond.

Carrier Pipe: The tube which carries the product being transported and which may go through casings at highway and railroad crossings. It may be made of steel, concrete, clay, plastic, ductile iron, or other materials. On occasion it may be bored direct under the highways and railroads.

Cased Bore: A bore in which a pipe, usually a steel sleeve, is inserted simultaneously with the boring operation. Usually associated with auger boring or pipe jacking.

Casing: A pipe used to line bore holes through which a pipe(s) called carrier pipes or ducts are installed. Usually not a Product Pipe.

Closed Face: The ability of a tunnel boring machine to close or seal the facial opening of the machine to prevent or slow the entrance of soils into the machine. Also may be the bulkheading of a hand dug tunnel to slow or stop the inflow of material.

Closed-circuit Television Inspection (CCTV): Inspection method utilizing a closed circuit television camera system with appropriate transport and lighting mechanisms to view the interior surface of sewer pipes and structures.

Creep: The dimensional change, with time, of a material under continuously applied stress after the initial elastic deformation.

Cured-in-place Pipe (CIPP): A lining system in which a thin flexible tube of polymer or glass fiber fabric is impregnated with thermoset resin and expanded by means of fluid pressure into position on the inner wall of a defective pipeline before curing the resin to harden the material. The uncured material may be installed by winch or inverted by water or air pressure, with or without the aid of a turning belt.

Deformed Reformed Pipe (DRP): A term used to describe some systems in which the liner is deformed to reduce its size during insertion, and then reverted to its original shape by the application of pressure and/or heat.

Directional Drilling: A steerable system for the installation of pipes, conduits, and cables in a shallow arc using a surface launched drilling rig. Traditionally, the term applies to large scale crossings in which a fluid-filled pilot bore is drilled using a fluid-driven motor at the end of a bend-sub, and is then enlarged with a back reamer to the size required for the product pipe. The required deviation during pilot boring is provided by the positioning of a bent sub. Tracking of the drill string is achieved by the use of a downhole survey tool.

Drill String: 1) The total length of drill rods/pipe, bit, swivel joint, etc. in a drill borehole. 2) System of rods used with cutting bit or compaction bit attached to the drive chuck.

Drilling Fluid/Mud: A mixture of water and usually bentonite and/or polymer continuously pumped to the Cutting Head to facilitate cutting, reduce required torque, facilitate the removal of cuttings, stabilize the borehole, cool the head, and lubricate the installation of the Product Pipe. In suitable soil conditions, water alone may be used.

Duckbill: Alternative name for the steering device attached to the front of a directional drilling string.

Elastic Modulus: A measure of the stress buildup associated with a given strain.

Face: Wall of the entrance pit into which the bore is made.

Flexural Modulus of Elasticity: Mathematically defined as the stress divided by the strain of the material; measure of the rigidity or stiffness of a material. A high flexural modulus indicates a stiffer material.

Flexural Strength: The strength of a material in bending expressed as the tensile stress of the outermost fibers at the instant of failure.

Fold and Form Pipe: A pipe rehabilitation method where a plastic pipe manufactured in a folded shape of reduced cross-sectional area is pulled into an existing conduit and subsequently expanded with pressure and heat. The reformed plastic pipe fits snugly to and takes the shape of the ID of the host pipe.

Guided Auger Boring: A term applied to auger boring systems, which are similar to microtunneling, but with the guidance mechanism actuator sited in the drive shaft (e.g. a hydraulic wrench that turns a steel casing with an asymmetric face at the cutting head). The term may also be applied to those auger boring systems with rudimentary articulation of the casing near the head activated by rods from the drive pit.

Impact Molding: Method of creating a bore using a pneumatic or hydraulic hammer within a casing, generally of torpedo shape. The term is usually associated with non-steered or limited steering devices without rigid attachment to the launch pit, relying upon the resistance of the ground for forward movement. During the operation the soil is displaced, not removed. An unsupported bore may be formed in suitable ground, or a pipe drawn in, or pushed in, behind the impact molding tool. Cables may also be drawn in.

Inversion: The process of turning a resin-saturated tube inside out by application of air or water pressure.

Jacking Frame: A structural component that houses the hydraulic cylinders used to propel the microtunneling machine and pipeline. The jacking frame serves to distribute the thrust load to the pipeline and the reaction load to the shaft wall or thrust wall.

Jacking Shield: A fabricated steel cylinder from within which the excavation is carried out either by hand or machine. Incorporated within the shield are facilities to allow it to be adjusted to control line and grade.

Launch Pit: Also known as Drive Pit, but more usually associated with "launching" an Impact Molding tool.

Liner Plate: A product used to line tunnels instead of casing, and comes in formed steel segments. When these segments are bolted together, they form a structural tube to protect the tunnel from collapsing. The segments are made so that they may be bolted together from inside the tunnel.

Microtunneling: A trenchless construction method for installing pipelines with the following features: (1) Remote controlled - The microtunneling boring machine (MTBM) is operated from a control panel, normally located on the surface. Personnel entry is not required for routine operation. (2) Guided - The guidance system usually references a laser beam projected onto a target in the MTBM. (3) Pipe jacked - The process of constructing a pipeline by consecutively pushing pipes and MTBM through the ground using a jacking system for thrust. (4) Continuously supported – Continuous pressure is provided to the face of the excavation to balance groundwater and earth pressures.

Mixed Face: A soil condition that presents two or more different types of material in the path of the bore.

Modulus of Elasticity (E): The stress required to produce strain, which may be a change of length (Young's modulus); a twist or shear (modulus or rigidity); or a change of volume (bulk modulus), expressed in dynes per square centimeter.

Open Cut: (*See also conventional trenching*) The method by which access is gained to the required level underground for the installation, maintenance or inspection of a pipe, conduit or cable. The excavation is then backfilled and the surface restored.

Open Face Shield: Shield in which manual excavation is carried out from within a steel tube at the front of a pipe jack.

Ovality: The degree of deviation from perfect circularity, or roundness, of the cross section of a pipe.

Pilot Bore: The action of creating the first (usually steerable) pass of any boring process which later requires back-reaming or similar enlarging. Most commonly applied to Guided Boring, Directional Drilling, and 2-pass microtunneling systems.

Pipe Bursting: A replacement method, also known as Pipe Cracking and Pipe Splitting. A technique for breaking the existing pipe by brittle fracture, using force from within, applied mechanically, with the remains being forced into the surrounding ground. At the same time, a new pipe, of the same or larger diameter, is drawn in behind the bursting tool. The pipe bursting device may be based on an Impact Molding tool to exert diverted forward thrust to the radial bursting effect required, or by a hydraulic device inserted into the pipe and expanded to exert direct radial force. Generally, a PVC or HDPE pipe is used.

Pipe Eating: A replacement technique, usually based on microtunneling, in which a defective pipe is excavated together with the surrounding soil as for a new installation. The microtunneling shield machine will usually need some crushing capability to perform effectively. The defective pipe may be filled with grout to improve steering performance. Alternatively, some systems employ a proboscis device to seal the pipe in front used of the shield to collect and divert the existing flow, thus allowing a sewer, for example, to remain “live.”

Pipe Jacking: A system of directly installing pipes behind a shield machine by hydraulic jacking from a drive shaft such that the pipes form a continuous string in the ground.

Pipe Ramming: A non-steerable system of forming a bore by driving an open-ended steel casing using a percussion hammer from a Launch Pit. The soil may be removed from the casing by augering, jetting, or with compressed air.

Pipe Splitting: Replacement method for breaking an existing pipe by longitudinal slitting. At the same time, a new pipe of the same or larger diameter may be drawn in behind the splitting tool. See also Pipe Bursting.

Ramming: A percussion hammer is attached to an open end casing, which is driven through the ground. The spoil within the casing is removed to leave an open casing.

Reception/Exit Shaft/Pit: Excavation into which trenchless technology equipment is driven and recovered following the installation of the Product Pipe, conduit, or cable.

Resin Impregnation (Wet-out): A process used in cured-in-place pipe installation where a plastic coated fabric tube is uniformly saturated with a liquid thermosetting resin while air is removed from the coated tube by means of vacuum suction.

Resins: An organic polymer, solid or liquid; usually thermoplastic or thermosetting.

Shield: A steel cylinder at the face of a utility tunnel or casing, which may sometimes employ the use of a mechanical excavator and may be steerable, and provide hazard protection from the area covered.

Sliplining: (1) General term used to describe methods of lining with continuous pipes and lining with discrete pipes. (2) Insertion of a new pipe by pulling or pushing it into the existing pipe and grouting the annular space. The pipe used may be continuous or a string of discrete pipes. This latter is also referred to as Segmental Sliplining.

Slurry: A fluid, normally water, used in a closed loop system for the removal of spoil and for the balance of groundwater pressure during microtunneling.

Swab (Bull Plug): A steel plug that is pulled through a horizontal bore to remove the cuttings.

Thermoset: A material, such as epoxies, that will undergo or has undergone a chemical reaction by the action of heat, chemical catalyst, ultraviolet light, etc., leading to an infusible state.

Trenchless Technology: Techniques for utility line installation, replacement, rehabilitation, renovation, repair, inspection, location and leak detection, with minimum excavation from the ground surface.

Tunnel Boring Machine (TBM): (1) A full-face circular mechanized shield machine, usually of Man-Entry diameter, steerable and with a rotary cutting head. For pipe installation, it leads a string of jacked pipes. It may be controlled from within the shield or remotely. (2) (Mole, Tunneling Head) A mechanical excavator used in a tunnel to excavate the front face of the tunnel.

Tunneling: A construction method of excavating an opening beneath the ground without continuous disturbance of the ground surface and of large-enough diameter to allow individuals access and erection of a ground support system at the location of material excavation.

Upsizing: Any method that increases the cross sectional area of an existing pipeline by replacing with a larger diameter pipe.

Utility Tunneling: A process in which a temporary support liner is constructed as the tunnel is excavated. The liner typically consists of steel or concrete liner plates, steel ribs with wood lagging, or an all wood box culvert. Personnel are required inside the tunnel to perform the excavation and/or spoil removal.

Wing Cutters: Appendages on cutting heads that will open to increase the cutting diameter of the head when turned in a forward direction, and close when turned in a reverse direction. They are used to cut clearance for the casing pipe.

Definitions Source: North American Society for Trenchless Technology.

Commonly Used Trenchless Technologies

A. Techniques Common in the United States

Several trenchless technologies are commonly used in the United States. They are separated into two categories based on whether they are used most frequently for new construction or reconstruction.

New Construction:

- Auger Boring
- Compaction Boring
- Pipe Ramming
- Slurry Methods
- Horizontal Directional Drilling
- Pipe Jacking and utility tunneling
- Microtunneling

Reconstruction:

- Cured in place pipe
- Fold and formed pipe
- Sliplining
- Pipe Bursting

Each of these technologies is discussed in greater depth in Parts 14B and 14C.

B. Techniques Common in Iowa

A study was conducted by the Iowa Highway Research Board (IHRB) to determine which trenchless methods were the most prevalent within the State of Iowa. This study, included responses from both the public and private sector, determined which trenchless technologies are the most commonly used construction methods within the State of Iowa. The study indicated that horizontal directional drilling (HDD), auger boring, and pipe jacking are the most common new construction technologies used within Iowa. For rehabilitation work, cured-in-place pipe is the most commonly used technology in Iowa.

Planning a Bore

A. Bore Pit Locations

Careful consideration should be given to the location of the bore. Adequate room for launch and reception pits, if necessary, should be provided. Potential utility conflicts with the bore pit should be identified and addressed. Restricting the size of the bore pit or work area may affect the boring method that can be used. When unsure about the size of bore pit required for a particular technique, it is recommended that the designer contact a boring contractor for additional information.

B. Manhole Locations

When possible, manholes should be located at both ends of a long or difficult bore. This allows minor deviations in line or grade between the bore and the open cut section to be corrected. In addition, it provides access to both ends of the section of pipe for maintenance purposes.

C. Bore Lengths

The length of the bore specified needs to be carefully considered. Crossing under a 24 foot roadway requires a bore longer than 24 feet. Adequate length to protect roadway and foreslope from loss of support and sloughing during bore entry and exit is required. If possible, it is desirable to place the bore pit locations beyond the roadway foreslope. For roadways with an urban section, the bore pits should be located several feet away from the back of the curb to prevent undermining of the roadway.

D. Acceptable Tolerances

The designer should recognize that as tolerance specifications tighten, the cost for boring will increase. Different trenchless methods have different tolerance limitations. Methods and machines that are able to meet tight tolerances tend to be more complex, and therefore, more costly. In addition, the contractor assumes a greater risk when agreeing to complete a bore with tight tolerance requirements.

Since every installation is unique, bore tolerances should be determined and specified on a case-by-case basis. Unless there are special circumstances, it would be unreasonable to require a water main or force main to meet the same tolerances as a gravity sewer line. In order to reduce costs, the designer should allow as much grade and alignment variation as possible while still meeting the operational requirements of the installation.

For example, assume a 12 inch sanitary sewer on a 1% grade is being bored for a length of 200 feet as shown in Figure 14B-1.01. Due to capacity/velocity limitations, the minimum allowable pipe slope is 0.5%. If the bore tolerances are set at $\pm 0.2\%$ (common for gravity sewers) the project would likely require the use of a significantly oversized casing pipe with the auger boring technique to allow for adequate adjustment, or would need to be done by microtunneling in order to ensure compliance with the specifications. Increasing the allowable tolerances to ± 12 inches, would likely allow the steered auger boring method to be utilized, without an oversized casing pipe. This could result in significantly reduced boring costs, while still meeting the minimum grade requirements of the sewer line.

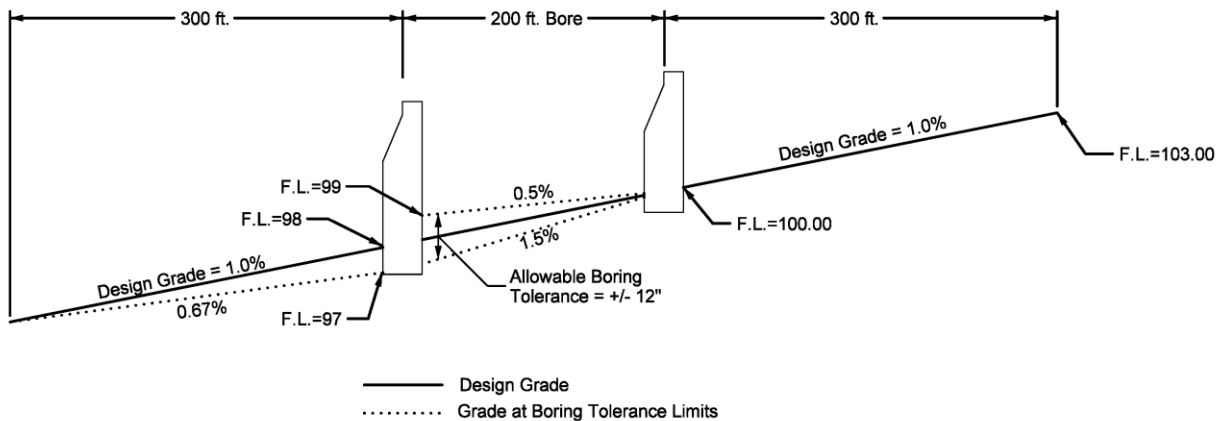
Figure 14B-1.01: Tolerance Considerations When Planning a Bore

For gravity sewers, which are laid at minimum grades, consideration should be given to providing additional slope through the length of the bore. While this may not always be possible, it helps reduce the potential for backfall in the pipe.

Often, the casing pipe may not meet the tolerances required in the specifications. However, the contractor normally has the ability to make grade corrections for the carrier pipe by using casing chocks. These chocks allow the position of the carrier pipe to be adjusted inside of the casing pipe as required to meet the specified grade. As mentioned above, for projects that require a high degree of accuracy, an oversized casing may be installed to allow additional maneuvering room inside the casing for the carrier pipe.

E. Information to Provide to Contractor

If soil borings were conducted, the soil boring log should be included with the specifications or at least be available upon request. The specifications should spell out in detail how unexpected circumstances will be handled. Will the contractor be entirely responsible if something goes wrong, or is there a risk allocation clause in place? In addition, the specifications should indicate what the tolerance requirements for the bore would be. Finally, the material requirements for the bore, including the casing pipe (see [Section 9C-1](#)), if required, should be indicated.

F. Risk Allocation

One of the factors that results in increased prices for tunneling and boring is the risk associated with the process. While soil borings and other information can provide a glimpse of the ground conditions that may be encountered, they do not provide the big picture. For example, a contractor may be nearing the end of a long bore when an unexpected large boulder or old foundation is struck. The only option may be to abandon the bore and begin again. Normally, the specifications place the costs associated with this upon the contractor. The boring contractors plan for these types of unexpected problems by increasing their bid prices to cover the costs associated with the additional work.

If the jurisdiction agrees to share in the costs that are associated with encountering differing site conditions, the contractor's risk is reduced, and they can lower their bid prices since they are no longer forced to "poke and hope."

By including a "differing site conditions" clause in the contract, the jurisdiction agrees to relieve the contractor from the burden of extraordinary costs required to complete its performance due to unexpected site conditions. This clause allows the contractor to negotiate an additional work order

when the site conditions encountered are different than those reasonably expected.

While the actual clause used in the contract documents may vary, the following is commonly used text found in federal contracts 48 C.F.R § 52.236-2. The intent of this language is to provide for an equitable adjustment, as well as the procedures necessary for a contractor to make a claim for differing site conditions:

1. The Contractor shall promptly, and before the conditions are disturbed, give a written notice to the Jurisdiction of (a) subsurface or latent physical conditions at the site which differ materially from those indicated in this contract, or (b) unknown physical conditions at the site, of an unusual nature, which differ materially from those ordinarily encountered and generally recognized as inhering in work of the character provided for in the contract.
2. The Jurisdiction shall investigate the site conditions promptly after receiving the notice. If the conditions do materially so differ and cause an increase or decrease in the Contractor's cost of, or the time required for, performing any part of the work under this contract, whether or not changed as a result of the conditions, an equitable adjustment shall be made under this clause and the contract modified in writing accordingly.
3. No request by the Contractor for an equitable adjustment to the contract under this clause shall be allowed, unless the Contractor has given the written notice required; provided, that the time prescribed in (1) above for giving written notice may be extended by the Jurisdiction.
4. No request by the Contractor for an equitable adjustment to the contract for differing site conditions shall be allowed if made after final payment under this contract.

G. Drawing on Contractor's Expertise

Once a tentative design has been laid out for a bore or tunnel, it may be prudent to discuss the proposed installation with an experienced tunneling and boring contractor. Most contractors are willing to discuss the practicality of a proposed installation, provide insight to potential problems, give a range of expected costs associated with the installation, and provide recommendations on how to reduce the overall cost of the project.

Methods of New Construction

A. Trenchless Methods for New Construction

The trenchless construction methods available for new facilities are divided into two main classes: Horizontal Earth Boring, which is performed without workers being inside the borehole, and Pipe Jacking / Utility Tunneling, which require workers inside the borehole during the excavation and casing processes. The chart below illustrates the various methods available.

Figure 14B-2.01: Classification of Trenchless Construction Methods

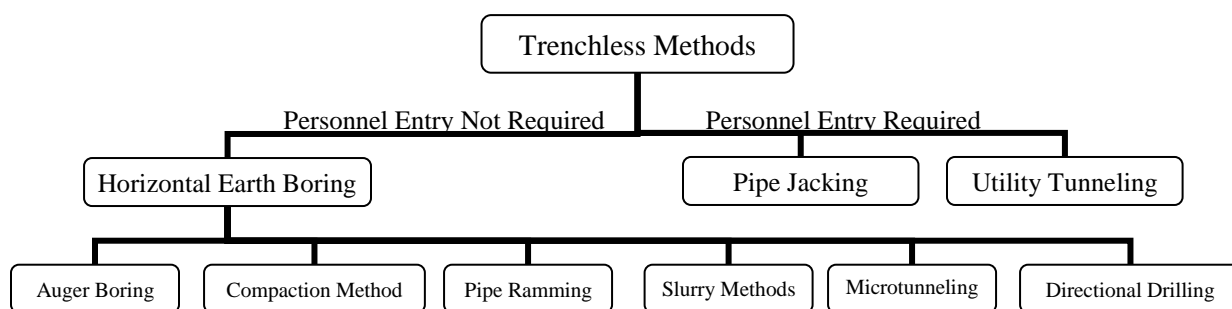

B. Expected Service Life for New Construction

The expected service life for a new pipe or other type of product installed by boring or tunneling is generally the same as a similar material installed by open cut methods. Due to the possibility of over-excavation, there may be some potential for surface settlement as the over-excavated bore settles around the casing pipe. This is especially true for shallow bores.

C. Auger Boring

- Description of Process and Equipment:** Auger boring is accomplished with an auger boring machine by jacking a casing pipe through the earth while at the same time removing earth spoil from the casing by means of a rotating auger inside the casing.

The typical auger boring installation begins with the installation of bore pits at the beginning and end of the proposed bore. Bore pit dimensions vary depending on the size and length of the casing being used and on the depth of the boring. Generally, the length varies from 26 to 40 feet long and 8 to 12 feet wide. The bottom of the bore pit is usually over-excavated and backfilled with crushed stone in order to provide adequate support for the equipment.

Most auger boring equipment is track mounted. The boring machine slides along this track in order to advance the casing pipe. The master track (on which the boring machine is set) is placed in the pit and set to the required line and grade of the bore. This is a critical step in the auger boring process since there is little ability to correct line or grade deviations once an auger bore is started. Steerable auger boring equipment is now common and does allow for some minor adjustment or bore direction as it progresses; however, proper setup is still critical.

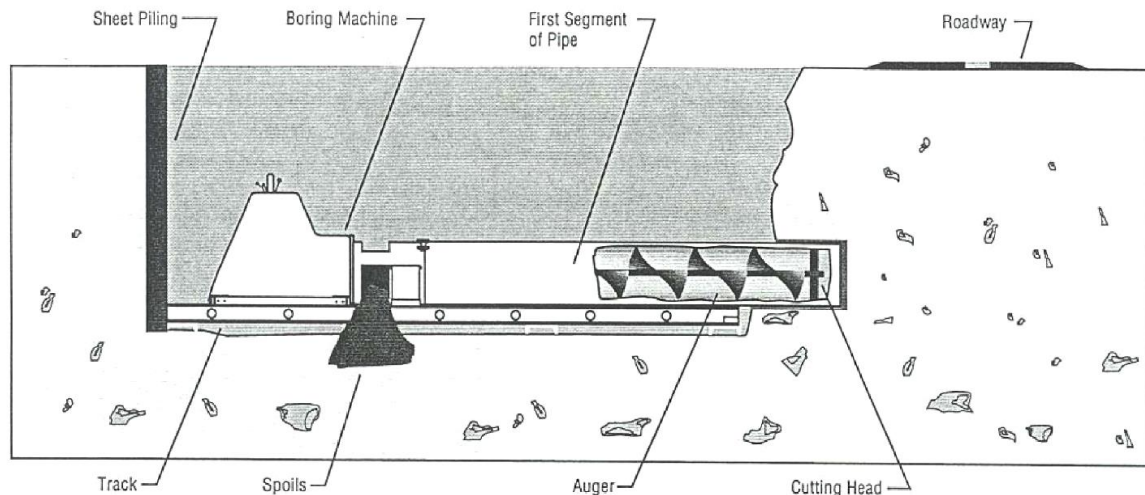
Figure 14B-2.02: Typical Auger Boring Setup

Source: Isley and Gokhale, 1997

The boring machine applies thrust in order to advance the carrier pipe. This thrust is applied against the back of the boring pit with hydraulic rams. In order to withstand this thrust, a backing plate is normally installed against the back wall of the boring pit. This backing plate normally consists of steel piling, a steel plate, or wooden timbers. For long or large diameter bores, a concrete backstop may be used in addition to a steel plate.

After installation of the master track and backing plate, the auger boring machine is set on the master track. A cutting head, compatible with the soil conditions expected, is installed on the front of the first auger section. The first section of casing pipe may have a steel band welded around the top 3/4 of the outside diameter of the pipe. This process, called banding, slightly over-excavates the borehole, thereby reducing skin friction on the following casing sections.

The bore is begun by carefully installing the first section of casing pipe to the correct line and grade. After the first section has been installed and checked for accuracy, the boring machine is disconnected from the casing pipe and auger and slid to the rear of the bore pit. The next section of casing pipe and auger are lowered into position. The second auger section is coupled to the first with an auger pin. The two casing sections are lined up and either welded together, or an interlocking casing pipe jointing system may be utilized.

The bore is then advanced by applying thrust and simultaneously rotating the flight augers inside the casing in order to remove spoil. This process is repeated until the required length of casing is installed.

Once the bore is completed, the cutting head is removed at the receiving pit, and the augers are pulled out at the entrance pit, disconnected, and removed.

If required, a carrier pipe can be installed. The carrier pipe is attached to pre-manufactured casing chocks. The carrier pipe is pushed into the casing pipe using the auger boring machine, or by pulling it through with a winch.

Most auger bores are done without the ability to steer the bore, that is, make line or grade adjustments once the bore has begun. However, equipment and techniques are available that do allow minor corrections or changes in alignment to be made.

2. **Typical Applications/Materials:** The auger boring technique is used extensively throughout every segment of the United States, and it is the most common method used for crossing roadways with storm sewer, sanitary sewer, or water main pipes.

In auger boring, the auger rotates inside the casing as it is being jacked. Consequently there is a danger that any interior pipe coatings may be damaged by the process. Due to the rotating augers and spoil removal process the interior of the casing pipe is subjected to during installation, the standard casing material used for auger boring is steel.

Normally, a carrier pipe is installed inside of the casing pipe. This carrier pipe is protected by the structural rigidity of the steel casing and can therefore be almost any standard pipe material.

3. **Range of Applications:**

- a. **Pipe Sizes and Bore Lengths:** The most common pipe sizes installed by auger boring are from 8 inches to 36 inches. For sizes smaller than 8 inches, slurry and compaction methods are more suitable and economical, especially where the line and grade are not critical. For diameters larger than 36 inches, where the line and grade are more critical, pipe jacking with tunnel boring machines provide greater accuracy and safety and may be more cost effectively.

This method was initially developed for bores between 40 and 70 feet, just long enough to cross under a two lane roadway. Since that time, advances in equipment capabilities have extended the range of this method. Typical bore lengths now ranges between 175 feet and 225 feet, with maximum bore lengths of greater than 600 feet possible.

- b. **Soil Conditions:** Auger boring methods can be used in a wide variety of soil conditions. However, soils with large boulders can cause problems with this method. Since the spoil is removed through the casing with an auger, any materials encountered must be able to fit between the auger flights in order to be carried out. In general, the largest boulder or other obstacle that this method can handle is limited to one third of the nominal casing diameter.

In addition, auger boring in sandy, cohesionless soils can be difficult and may cause settlement, if not done properly, due to a loss of ground ahead of the bore as the soil flows into the pipe.

- c. **Tolerances:** The accuracy achievable with auger boring methods is usually $\pm 1\%$ (both vertically and horizontally) of the length of the bore. Equipment, which allows the auger bore to be steered, is accurate within $\pm 0.1\%$ vertically and $\pm 1.0\%$ horizontally.

D. Compaction Boring

1. **Description of Process and Equipment:** Compaction boring is a method of forming a borehole by displacing and compacting the soil radially, rather than removing the soil. The compaction method can be divided into three sub classifications: the push rod method, the rotary method, and the percussion method.
 - a. **Push Rod Method:** The first type of compaction boring, the push rod method, consists of a machine that pushes or pulls a solid rod through the soil by hydraulic force, simply displacing the soil. The resulting bore hole is the same diameter as the rod. Typical rod diameters range from 1 3/8 to 1 3/4 inches. To further enlarge the hole, the machine can pull a reamer back through the hole. Rods are usually about 4 feet in length and can be linked in series to

achieve the desired bore length. Once the borehole is formed, a cable is used to pull the product into place.

- b. **Rotary Method:** The rotary method is similar to the push rod method; however, the rod used is similar to a drill bit. It is rotated as it is forced horizontally through the soil.
- c. **Percussion Method (Impact Molding):** The percussion method, also called impact moling, uses a self-propelled “mole” that is normally pneumatically powered. The mole is a torpedo shaped device that contains a reciprocating hammer in the nose. The action of this piston creates an impact force that propels the mole forward through the ground. Depending on ground conditions, the tools typically travel at a rate of 3 inches to 4 feet per minute. Once the mole exits into the receiving pit, the mole is removed and the air lines are used to pull a cable back through the borehole. This cable can then be used to pull the pipe product into place. If a rigid pipe is to be installed, it is simply pushed through the open borehole.

Figure 14B-2.03: Typical Percussion Setup

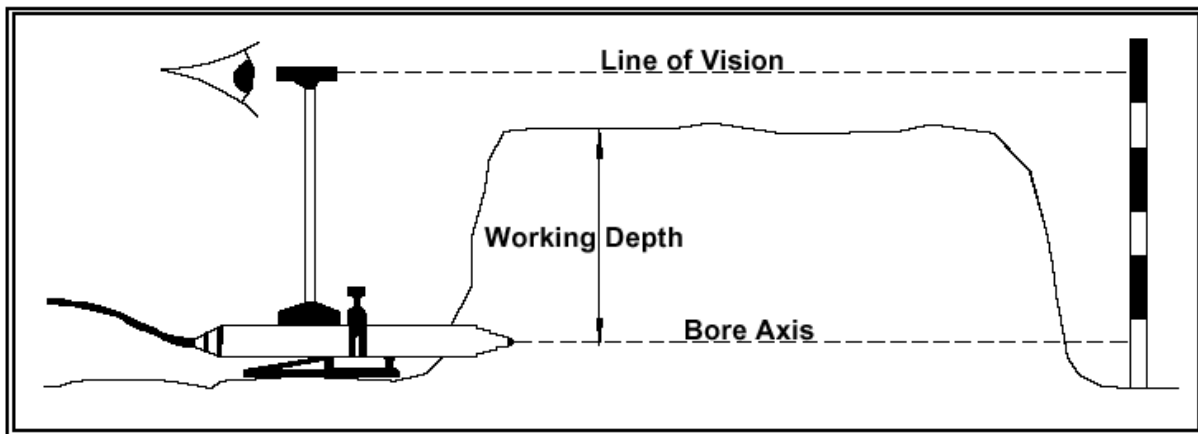

Source: Simicevic and Sterling, 2001

2. **Typical Applications/Materials:** Compaction boring methods are commonly used for installation of electric and communications cables, as well as gas lines, sprinkler irrigation systems, and water service lines. Since the boring process is independent of the pipe insertion process, almost any small diameter pipe or line can be installed by these methods.
3. **Range of Applications:**
 - a. **Pipe Sizes and Bore Lengths:** The size of product that can be installed by compaction methods is limited to the size of borehole that can be formed by the compaction method selected. The typical limit is 6 inches or less.

The size is further limited by the potential for ground disturbance above the bore. Since these compaction methods compress the surrounding soil and do not remove spoil, there is a potential for heaving. In order to avoid heaving problems, a rule of thumb to follow is to provide one foot of cover for every inch of bore diameter.

Due to the inaccuracy of the method and inability to control the direction of the bore, installation lengths are limited. The maximum practical bore length is typically 40 to 60 feet.

- b. **Soil Conditions:** Since these methods compact the soil around the borehole, moderately soft to medium hard compressive soils are best suited for these methods.

Rocks, boulders, and other obstacles can affect the accuracy the bore and cause it to stray away from the desired course.

- c. **Tolerances:** As mentioned previously, the accuracy of installation depends greatly on initial setup and ground characteristics. Once the bore is begun, there is no ability to control the direction of the bore. These methods are not normally used to install lines, which require a high degree of accuracy such as sanitary sewer lines.

- 4. **Relative Cost vs. Other Trenchless Methods:** Compaction methods for boring are highly economical. The equipment investment compared to other boring methods is very low. For short distance, small diameter bores, compaction methods are normally the lowest cost trenchless option available.

E. Pipe Ramming

- 1. **Description of Process and Equipment:** Pipe ramming is a trenchless method of installing a steel pipe or casing using a pneumatic tool to hammer the pipe or casing into the ground.

The pipe can be rammed with the leading edge either open or closed. Pipes up to 8 inches can be rammed with the end closed; however, this method is more difficult and is not normally recommended. When a closed end pipe is driven, the surrounding soil is displaced and compacted similar to the compaction methods previously described. This can result in ground heaving and is more susceptible to obstructions. More commonly, and always for larger diameters, the leading edge is left open. With the end of the pipe open, soil is allowed to enter the pipe during installation.

The lengths of pipe that can be rammed depend mainly on the space available at the site. If adequate room is available, the entire length of pipe can be welded together prior to installation and rammed as a single unit. When the available area is restricted, the pipe can be rammed in short sections, welding them together as the bore progresses.

A typical Pipe ramming installation begins with the installation of bore pits at the beginning and end of the proposed bore. Guide rails are set to the line and grade of the proposed bore. The first length of steel pipe is prepared by attaching a steel band around the outside of the leading edge of the pipe. The purpose of this band is to slightly overexcavate the borehole, thus reducing friction on the following pipe sections. The first section of pipe is set in place, and the ramming hammer is attached to the rear of the pipe. The ramming hammer's percussion force drives the steel pipe into the ground along the line dictated by the guide rails. When one section of pipe has been driven, the hammer is removed and, if necessary, the next length of pipe is welded in place. This process is repeated until the leading edge of the pipe arrives at the receiving pit.

When using an open-ended pipe, a cylinder of ground, equal to the pipe diameter, is forced into the pipe as the bore advances. Once the bore is completed, this spoil must be removed. There are several methods available to remove this spoil including auger, compressed air, or water jetting.

Figure 14B-2.04: Typical Open-face Pipe Ramming Setup

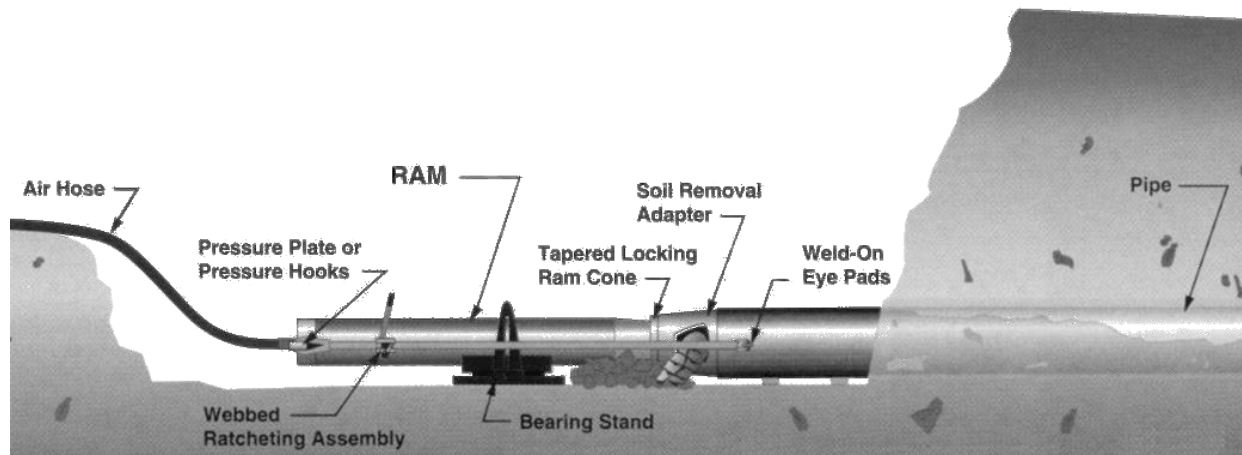

Source: ACCU-Pipe Ramming Systems Inc.

2. **Typical Applications/Materials:** This method is frequently used under railway and road embankments for installation of medium to large diameter pipes.

Steel pipe is used for the casing, as no other material is strong enough to withstand the impact forces generated by the hammer. Upon completion, a carrier pipe can be installed inside of the steel casing pipe. This carrier pipe is protected by the structural rigidity of the steel casing and can, therefore, be almost any standard pipe material.

3. **Range of Applications:**

- a. **Pipe Sizes and Bore Lengths:** Common pipe sizes installed by ramming range from 2 inches to 55 inches; however, pipe sizes as large as 147 inches have been done.

Pipe ramming is typically used for pipe installations over relatively short distances, usually less than 150 feet. However, lengths as long as 300 feet may be successfully installed.

- b. **Soil Conditions:** Pipe ramming can be used in almost all types of soil conditions except solid rock. Pipe ramming is generally more successful than auger boring in rocky ground, as the leading edge and percussion force tends to act as a splitter to fracture the cobbles that are encountered.
- c. **Tolerances:** Pipe ramming is a non-steerable method. Once the bore has begun, there is little control over the line and grade of the installation. Soil conditions and ground obstructions such as rocks and cobbles can cause the bore to stray from the intended line and grade. The accuracy of the pipe ramming method is usually better than $\pm 1\%$ (both vertically and horizontally) of the length of the bore.

4. **Relative Cost vs. Other Trenchless Methods:** Compared to other trenchless methods such as augering and directional drilling, pipe ramming can save both installation time and costs under appropriate conditions. Installation time may be shorter than for augering because the required bore pits are smaller and actual installation is faster. Pipe ramming is generally less costly than directional boring for short bores of 60 feet or less; however, directional drilling is generally better suited for longer bores.

F. Slurry Methods

- 1. Description of Process and Equipment:** Slurry methods involve the use of a drilling fluid, such as water or bentonite slurry to aid in the drilling process and spoil removal.

Slurry methods can be divided into two classifications: slurry boring and water jetting.

- a. Slurry Boring:** Slurry boring normally begins by constructing a bore pit. The boring machine is set in the pit and adjusted to the appropriate line and grade. A pilot hole is formed by advancing drill tubing, with a drill bit attached to the end, through the ground. As the bit is advanced, drilling fluid is pumped through the tubing to the drill bit in order to lubricate the pilot drill and reduce the friction created by the advancing bore. Once the pilot bore reaches the receiving pit, a back reamer can be pulled or a forward reamer can be pushed through the ground to increase the bore to the required diameter.

As the reamer is forced through the ground, drilling fluid is pumped into the bore. Depending on soil type, this drilling fluid may be either water or a bentonite mixture. The soil is mechanically cut by the reamer and mixed with the drilling fluid. These cuttings are held in suspension forming a slurry. This slurry helps prevent the uncased borehole from collapsing by exerting hydrostatic pressure against the walls of the bore.

After the reaming process is completed, the bore is swabbed by pulling a plug through the bore, thereby forcing the slurry and cuttings out of the borehole. A casing pipe is inserted in conjunction with, or shortly after, the swabbing process.

The size of the borehole is larger than the outside diameter of the casing pipe. The void between the pipe and the bore should be filled with grout to prevent ground settlement above the bore.

- b. Water Jetting:** Another method of forming a borehole is the water jetting method. As the name implies, water jetting relies on a high speed jet of water to liquefy and remove soil. A special nozzle is attached to the end of a rod and extended forward into the bore. The jet of high-pressure water is used to perform all of the cutting and to wash the cuttings out of the bore. There is little ability to control the direction of the bore, since the jet of water will follow the path of least resistance. There is also little control over the amount of material excavated by the process and over-excavation is inevitable. Over time, this over-excavation will cause ground settlement. Due to these reasons, water jetting is rarely allowed by most jurisdictions.

A distinction between water jetting and slurry boring should be made. Water jetting uses the force of water to erode the borehole and, therefore, is generally not recommended. Slurry boring is a mechanical process, and jetting of the soil should not occur if performed correctly.

- 2. Typical Applications/Materials:** Since the boring process is independent of the pipe insertion process, almost any type of casing or carrier pipe can be installed by slurry methods.

Slurry methods are most commonly used for placing non-gravity flow installations. Gravity flow sewers with sufficient grade may be successfully installed by this process; however, there may be some difficulty maintaining a straight grade alignment due to the tendency of the bore head to drop as the bore advances.

Some jurisdictions may prohibit the use of slurry methods because, until the casing pipe is inserted, the bore is unsupported.

3. Range of Applications:

- a. Pipe Sizes and Bore Lengths:** This method is most commonly used for small diameter bores. Pipe sizes between 2 inches to 12 inches are the most common.

Due to the inability to steer the bore head, slurry methods are typically used for relatively short bores ranging from 40 to 75 feet.

- b. Soil Conditions:** While the process for completing the bore may vary based upon the soil types, slurry boring can be utilized under most ground conditions.
- c. Tolerances:** Slurry boring is a non-steerable method that depends greatly on the operator's skill. For stable, homogeneous soil conditions, bores up to 60 feet can be expected to be within $\pm 1\%$ (both vertically and horizontally) of the length of the bore.

G. Horizontal Directional Drilling

- 1. Description of Process and Equipment:** Horizontal directional drilling can be divided into two main classes, Mini-HDD and HDD, based upon the size of the product being installed and the length of the bore. Mini-HDD is for drive lengths of less than 600 feet and pipe sizes up to 10 inches in diameter. Pipe diameters between 12 and 60 inches and pipe lengths over 2,000 feet can be installed by HDD. The distinction between Mini-HDD and HDD is made mainly due to the types of equipment involved.

Mini-HDD systems are used extensively in the private utility industry for installing power lines, telecommunications cables, or gas lines at shallow depths. Mini-HDD equipment normally consists of an all-in-one, self-powered unit, which may be mounted on tracks and can be transported on a single trailer. The HDD systems used to install larger pipe diameters are monsters by comparison. These systems may occupy a space as large as 150 feet by 250 feet and arrive on the jobsite in as many as 10 trailers.

Figure 14B-2.05: Typical Large Scale HDD Boring Machine (Megadrill Asia)

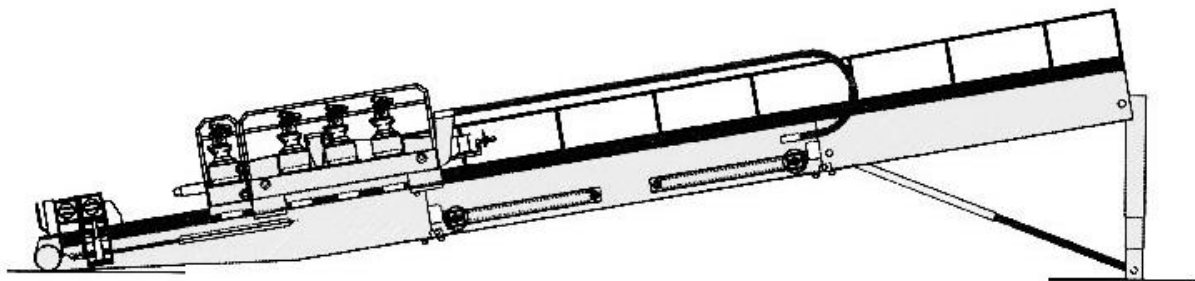

Source: Megadrill Asia

Regardless of the category of directional drilling, the basic process is the same. Although they can be set in a bore pit, the directional drill rig is normally set up on the ground surface. A pilot bore is begun by pushing a drill rod through the ground at a shallow angle (approximately 12 degrees). When the drill head reaches the desired depth, the bore head is steered along a sag shaped curve until it levels out. The pilot bore then continues through the ground at the desired depth and grade until it reaches a receiving pit or the head is once again steered through a sag shaped curve to exit the ground at the surface.

As the name implies, directional drilling is a boring method that can be remotely steered. This is accomplished through the use of a slanted, or anvil shaped device, often called a duckbill. The duckbill attaches to the front of the drill head. The angle of the duckbill causes the drill head to move along a curved path. In order to change the direction of the bore, the drill stem and duckbill are rotated to a position that will cause the bore to move in the desired direction. To bore in a straight line, the drill stem and duckbill are rotated continuously as the bore is advanced. For larger diameter bores, the duckbill may be replaced with a section of slightly bent or curved pipe called a bent sub. This bent sub has the same purpose and effect as the duckbill.

Figure 14B-2.06: Typical Duckbill

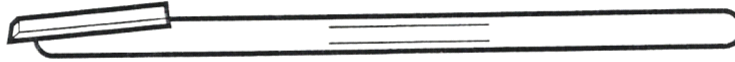

Source: Sterling and Thorne, 1999

In order to steer a bore around obstacles, the operator must know the location of the borehead and the direction it is traveling. This information is provided through the various tracking systems that are available. The most common method is a “walk-over” system. A radio transmitter or “sonde” is located directly behind the bore head and transmits a signal. A receiver, similar to those used by utility companies to detect underground pipes or cables, is used to determine the location and depth of the borehead. The drawback of the walkover system is that it may be difficult to gain access to the area directly above the borehead (i.e. for water crossings, or bores under buildings). There are also “hardwire” tracking systems available. These systems relay information such as head location, depth, and inclination and orientation of the head back to a computer. Based upon this information, the operator can make any necessary adjustments to keep the bore on the desired alignment.

For small diameter bores, the product pipe or cable can often be pulled back through the pilot hole with no additional enlargement of the hole required. However, for larger diameter pipes, it is necessary to increase the diameter of the pilot hole to accommodate the product pipe. This is accomplished by back reaming.

After the pilot bore is completed, the drill head is removed and a back reamer is attached to the drill string. The back reamer serves two functions. The first and most obvious is to enlarge the diameter of the borehole to a size large enough to allow room for the product to be installed. As a rule of thumb, the size of the borehole is normally reamed to a diameter of 1.5 times the diameter of the product to be installed. The second function of the reamer is to mix the soil cuttings with the drilling fluids to create a slurry. The reamer is rotated and pulled back through the pilot hole, thereby cutting the soil and increasing the diameter of the bore. At the same time, drilling fluid is pumped through the drill string to the reamer. The cuttings mix with the drilling fluid, forming a slurry. Some of this slurry is forced out of the borehole, into the receiving pit. However, most of the slurry remains in place to support the borehole, and keep it from collapsing until the product pipe is pulled into place.

Upon completion of the boring and reaming processes, the product assembled into one full length. It is laid out in-line with the bore and pulled into place. As it is pulled into place, the required volume of slurry is forced out of the hole. The remaining slurry between the outside of the pipe and the inside of the reamed borehole remains in place permanently to provide support to the borehole.

- 2. Typical Applications/Materials:** Directional drilling can be used to install a variety of pipelines, including cables, pressurized gas or water lines, sewer force mains, and water services. Steel and HDPE are the most common types of materials installed by directional drilling; however, PVC, copper, and other flexible materials can also be successfully installed.

Although it can be done, directional drilling can be difficult for installing products at small slopes. Therefore, it may not be suitable for installing gravity pipelines.

3. Range of Applications:

- a. Pipe Sizes and Bore Lengths:** As mentioned previously, Mini-HDD is for drive lengths of less than 600 feet and pipe sizes up to 10 inches in diameter. HDD can accommodate pipe diameters between 12 and 60 inches and pipe lengths over 2,000 feet.
- b. Soil Conditions:** Directional boring techniques can be utilized under many different soil conditions. Clays, silts, and sands are considered ideal. Directional drilling in gravelly or rocky ground can be done; however, speed and accuracy may be reduced considerably.
- c. Tolerances:** The accuracy for directional drilling varies depending on ground conditions and operator experience. Normally, an accuracy of $\pm 1\%$ of the length of the bore can be expected for HDD and within 6 to 12 inches for Mini-HDD.

- 4. Relative Cost vs. Other Trenchless Methods:** Installation of small diameter pipe and cable by Mini-HDD techniques is very economical and is, quite often, less expensive than open cut techniques. In fact, Mini-HDD is often preferred over open cut even in wide open areas due to its lower overall cost.

Installation by HDD of large diameter pipelines is a highly specialized operation requiring special equipment. Given this, it is not economically feasible for relatively short bores. However, given sufficient bore length, HDD can become an economical alternative due to the minimal environmental impact speed of installation.

- 5. Potential Problems with HDD:** While HDD is not intended to be a compactive method of installation, a poor choice of drilling fluid or other installation errors can lead to compaction around the installed pipe. This unintended compactive effort can lead to frac out and/or lifting of the soils.

Figure 14B-2.07: Pavement Cracking Caused by HDD Installation



Source: Iowa Highway Research Board Project TR-570

Shallow HDD bores under pavements can result in pavement cracking, as seen in the left picture in the above figure. A general rule of thumb is that the depth of the installation should be one foot per inch of pipe being installed.

HDD installations that are not back-reamed to a sufficiently large diameter have been observed to cause heave. When the product pipe is pulled into the hole, some of the drilling fluid is displaced and must flow out of the hole. The drilling fluid is expected to pass in the opposite direction that the pipe is being pulled and therefore must travel through the annular space between the outside of the pipe and the edge of the hole. The rule of thumb for HDD is that the diameter of the hole should be 1.5 times the outside diameter of the pipe. However, sometimes contractors do not include the thickness of the pipe and bells or other protrusions on the outside of the pipe when they calculate pipe diameter. If the machine generates high enough pulling force, drilling fluid pressure can become high enough to heave the soil. An example of soil heaving is seen in the above figure.

H. Pipe Jacking and Utility Tunneling

1. **Description of Process and Equipment:** The processes of pipe jacking and utility tunneling are two distinctly separate methods, but are both characterized by their necessity for workers to enter the pipe to perform the excavation.
 - a. **Pipe Jacking:** Pipe jacking is a trenchless technique in which a casing pipe is pushed, or jacked, into the ground, while at the same time, soil is excavated by personnel at the front of the bore.

The setup for a pipe jacking operation begins in a manner similar to that for auger boring. Bore pits are excavated at the entrance and exit of the proposed bore. A guide rail, or jacking frame, is placed to support the pipe and the jacking equipment, and a thrust block (normally concrete) is installed.

A jacking shield is pushed into the ground, ahead of the following pipe sections. The purpose of the jacking shield is to provide a safe area for workers to perform the excavation at the face (front) of the bore. This excavation may be done manually or mechanically, as discussed below.

Spoil is normally removed from the bore using small carts which are either battery powered, or pulled in and out with a winch. Alternatively, the spoil may be removed with small augers, or by using a conveyer system.

As excavation takes place, hydraulic jacks at the entrance pit force the pipe through the ground. The pipe is jacked in sections. When one section is completed, the hydraulic jacks are moved back, another section of pipe is set at the entrance pit, and the process is repeated until the bore reaches the reception pit.

Pipe jacking is a very accurate method of boring. A laser back at the bore pit is set to the appropriate line and grade and shot through the pipe to a target at the front of the bore. Workers can view the laser beam to determine what corrections need to be made. All modern equipment incorporates an automatic steering system. The bore is steered by adjusting the jacking forces back at the bore pit or at the face of the bore.

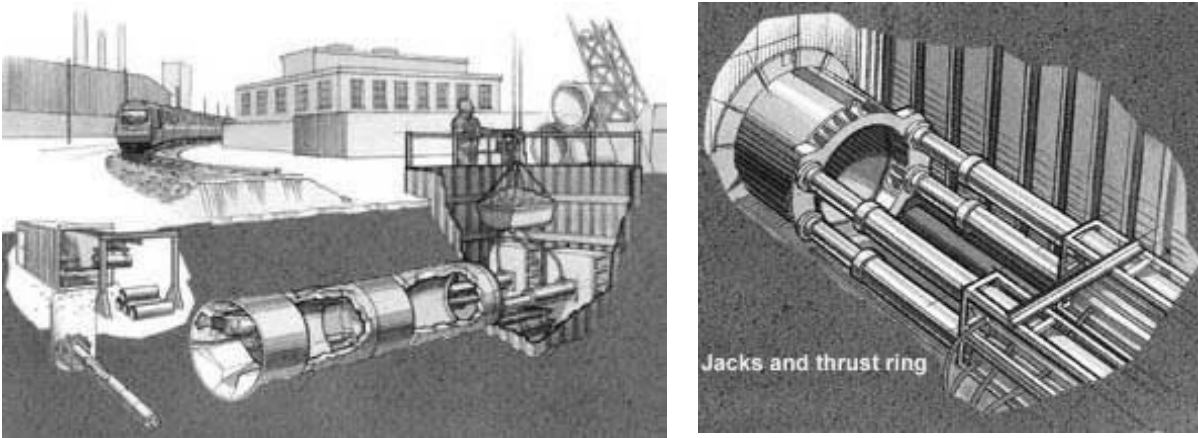
Figure 14B-2.08: Typical Pipe Jacking Installation

Source: The Pipe Jacking Association

- b. Utility Tunneling:** Like pipe jacking, utility tunneling excavation is done inside of a specially designed tunneling shield. The method is differentiated from pipe jacking by the lining installed, and the method of jacking.

In pipe jacking, pipe forms the lining of the borehole. In utility tunneling, steel liner plates or rib and lagging form the liner. The liner plates are prefabricated modular units utilized to construct a temporary lining. This temporary lining supports the excavation until it is complete. Upon completion, the permanent utility pipe is pushed through the tunnel, and the annular space between the steel lining and the pipe is filled.

Another distinction between utility tunneling and pipe jacking is that this liner is not jacked or pushed into place. It is constructed in-place in the tail section of the shield. Hydraulic jacks or rams are not required in the bore pit. Rather, as the tunnel is extended, hydraulic jacks on the rear section of the tunneling shield thrust against the previously installed liner plates, pushing the shield forward. After the shield has been pushed forward far enough so that one or more courses of liner plates can be placed, the jacking operation ceases and the jacks are retracted so that the liner plates can be installed in the tail section of the shield.

Like pipe jacking, excavation inside of the shield is done by personnel, either manually or mechanically as discussed below. The spoil is removed from the bore with either small carts, augers, or a conveyer system.

Figure 14B-2.09: Typical Utility Tunnel Installation

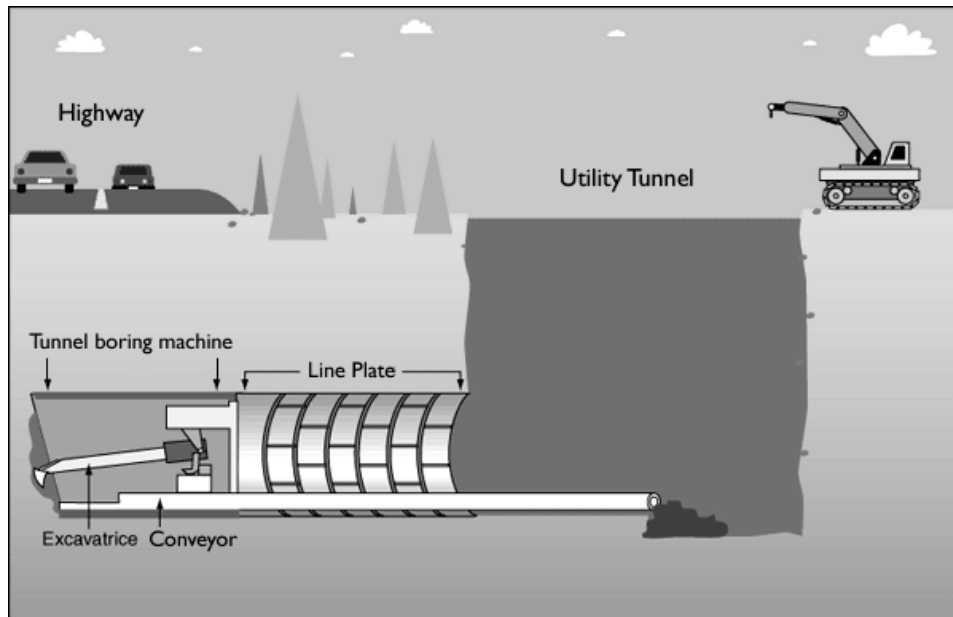

Source: Nella Drilling, Inc.

- c. **Pipe Jacking and Utility Tunneling Excavation Methods:** Several different methods are available for excavating the spoil for a pipe jacking or utility tunneling project. These methods include hand mining, open face shield, tunnel-boring machine, and the road header method.
- 1) **Hand Mining:** Hand mining is the most basic method of excavation. It consists of workers using either pneumatic equipment or simply picks and shovels to excavate the material away from the face of the bore. This method is very slow, but has distinct advantages. Workers can readily address mixed face conditions, boulders, and other large obstacles such as tree stumps. This method is limited to relatively short drives that do not justify the investment in tunneling equipment, or to conditions that demand hand tunneling.
 - 2) **Open Face Shield:** As the name implies, the open face shield method consists of an exposed face at the front of the shield. Excavation is done by a small backhoe or other piece of equipment mounted inside of the shield. Like hand mining, this method allows workers full access to the face of the bore to deal with poor soil conditions or obstacles in the path of the bore.
 - 3) **Road Header Method:** A road header is a wheel or track mounted piece of equipment with a toothed sphere attached to the end of a boom. The ball is rotated and used to excavate soil or rock from the face of the bore. This method is particularly useful in non-circular tunnels.
 - 4) **Tunnel Boring Machines:** Excavation by tunnel boring machine is the most common method of excavation for pipe jacking; however, its use is limited to circular tunnels. A tunnel boring machine is a full face machine, which means that the face of the excavation is fully supported by the cutting head. The cutting head rotates and excavates soil from the face. This soil passes through small openings in the cutting head. An operator sits at the front of the bore, immediately behind the cutting head. From this vantage point, the operator can steer the bore and make any necessary adjustments. Tunnel boring machines are fast and efficient, especially for long bores.

2. **Typical Applications/Materials:** Pipe jacking is used primarily for conduits that must conform to tight tolerances such as culverts and gravity storm and sanitary sewers. Jacking pipe materials must be able to withstand the high compressive forces that are involved in the process. Typical jacking pipe can be steel, reinforced concrete, centrifugally cast glass-fiber-reinforced polymer mortar (CCFRPM - Hobas) pipe, or vitrified clay. In many cases, the jacking pipe also doubles as the carrier pipe. If a separate carrier pipe is installed, it can be almost any pipe material, including plastic or other flexible pipe.

Utility tunneling is also used for installing utility conduits such as storm sewers, sanitary sewers, and culverts. Utility tunneling should be differentiated from the major tunneling installations that are used as passageways for pedestrians or vehicles. As discussed above, utility tunneling involves the installation of prefabricated steel liner plates as a temporary support structure. The final carrier pipe needs to be of sufficient strength to withstand the forces imparted during the grouting of the annular space, and any potential earth loads transferred to the carrier pipe.

3. **Range of Applications:**

- a. **Pipe Sizes and Bore Lengths:** Since both pipe jacking and utility tunneling require workers to enter the excavation, these methods are typically limited to pipe sizes 42 inches and greater. For extremely long installations, the minimum recommended size is 48 inches.

Theoretically, the length of pipe jacking and utility tunneling installations is unlimited. Since the liner pipe is not pushed through the ground for utility tunneling, forces do not increase as the length of the tunnel increases. Pipe jacking lengths can be increased through the use of intermediate jacking stations. The intermediate jacking stations may be installed at intervals along the pipe, and allow the pipe to be jacked in sections, rather than all at once.

- b. **Soil Conditions:** While stable consistent granular and cohesive soils are the most favorable for these methods, pipe jacking and utility tunneling can be utilized in almost all soil conditions with the appropriate equipment and precautions.
- c. **Tolerances:** Pipe jacking and utility tunneling are highly accurate, steerable methods. Installations within 1 inch of proposed line and grade are possible.

4. **Relative Cost vs. Other Trenchless Methods:** Pipe jacking and utility tunneling are specialized operations that require a significant investment in equipment. Typically, these methods are significantly more expensive than auger boring or other trenchless methods (except microtunneling) due to the equipment investment required.

I. Microtunneling

1. **Description of Process and Equipment:** The microtunneling process is essentially remote controlled pipe jacking. All operations are controlled remotely from the surface, eliminating the necessity for personnel to enter the bore.

The excavation is made with a remotely controlled tunnel boring machine. Like pipe jacking, the tunnel boring machine is laser guided and can be steered to maintain the required grade and alignment.

The spoil generated can be removed by either mixing the soil with water into a slurry and pumping it out of the bore or by removing the spoil with an auger inside a separate auger casing inside the jacking pipe.

2. Typical Applications/Materials: Like pipe jacking, microtunneling is normally utilized for constructing pipelines requiring a high degree of accuracy, such as gravity storm sewers and gravity sanitary sewers. Similar to pipe jacking, the casing pipe must be able to withstand the high jacking forces required to push the pipeline through the ground. Common pipe materials installed with microtunneling include steel, ductile iron, reinforced concrete pipe, centrifugally cast fiberglass-reinforced polymer mortar (CCFRPM) pipe, and vitrified clay pipe.

3. Range of Applications:

a. Pipe Sizes and Bore Lengths: The term “microtunneling” can be deceiving. Microtunneling was originally developed as a pipe-jacking technique for pipe diameters too small to allow man entry. Since that time, the sizes of pipes installed by microtunneling have continued to increase due to the benefits and added safety provided by eliminating the requirement for personnel to enter the bore. Now, almost any diameter of pipe can be installed by the microtunneling technique from 10 inches to 120 inches. For example, the Chunnel, with a diameter of 25 feet, was constructed using microtunneling techniques.

One limitation of microtunneling is that since the excavation must be done with a tunnel boring machine, only circular pipes can be installed.

b. Soil Conditions: Microtunneling can accommodate a wide variety of soil conditions. Boulders or rocks up 20% to 30% of the diameter of the pipe can normally be removed.

c. Tolerances: Like pipe jacking, microtunneling is a laser-guided method, which is steerable and highly accurate. Installations within 1 inch of proposed line and grade are possible.

4. Relative Cost vs. Other Trenchless Methods: Microtunneling equipment is highly specialized and costly. However, due to the advantages and speed that the method provides, unit prices on large projects can be in line with other trenchless methods. For relatively short bores, microtunneling tends to be costly.

Table 14B-2.01: Summary of Various Trenchless Techniques for New Construction

Method	Diameter Range (inches)	Maximum Installation Length (feet)	Pipe Material	Working Space Requirements	Typical Application	Accuracy / Tolerances
Auger Boring Steered Auger Boring	4 to 60	600	Steel	Entry and Exit pits: 26 to 36 feet long	Road and Railroad Crossing Pressure and Gravity Pipe	± 1% of Bore Length ± 12 inches
Compaction Methods	Less than 12	200	Any	Large area required to accommodate bore pit and to lay out pipe	Pressure Pipe/Cable	± 1% of Bore Length
Pipe Ramming	2 to 55	200	Steel		Road and Railroad Crossing	Not Accurate
<u>Slurry Methods:</u> Water Jetting Slurry Boring	Less than 4 Varies	30 Varies	Any	Minimal	Pressure Pipe/Cable	Not Accurate
<u>Directional Methods:</u> Mini-HDD HDD	2 to 12 12 to 60	600 Greater than 2,000	PE, Steel, PVC PE, Steel	Boring pits not generally required. For HDD, need space to set up rig: up to 400 feet long	Pressure Pipe/Cable Pressure Pipe	Varies
Microtunneling	8 and Greater	750	RCP, GPMP, VCP, DIP, Steel, PVC, PCP	Jacking Pit: 20 feet long Requires smaller retrieval pit	Gravity Pipe	± 1 inch
Pipe Jacking	42 and Greater	1,600	RCP, GPMP, Steel	Jacking Pit: 10 to 30 feet long	Pressure and Gravity Pipe	± 1 inch
Utility Tunneling	42 and Greater	Unlimited	RCP, GPMP, Steel	Launch Pit: 10 to 30 feet long	Pressure and Gravity Pipe	± 1 inch

Abbreviations:

DIP - Ductile Iron Pipe

PE - Polyethylene

VCP - Vitrified Clay Pipe

GRP - Glass-Fiber Reinforced Polyester

PVC - Poly-Vinyl Chloride

GPMP - Glass-Fiber Polymer Mortar Pipe

RCP - Reinforced Concrete Pipe

Source: Trenchless Construction Methods and Soil Compatibility Manual, 1999

Evaluation of Existing Conditions for Rehabilitation

A. Introduction

As existing sewers and manholes begin to deteriorate and fail, the traditional response has been to remove and replace them. However, there are alternatives available that can rehabilitate the sewer line or manhole, significantly extending the service life of the installation, normally at a lower dollar cost and with less inconvenience to the general public.

Rehabilitation techniques for sewer lines include cured-in-place pipe, fold-and-formed pipe, pipe sliplining, and pipe bursting. Manhole rehabilitation techniques include resin coating, centrifugally cast mortar, and structural liners.

B. Evaluating the Condition of the Existing System

The first step in deciding to rehabilitate a sewer pipe and selecting an appropriate rehabilitation technique is to conduct a thorough inspection of the sewer in order to determine the condition of the existing line. This evaluation should include an assessment of the sewer's structural condition, capacity, and the amount of inflow and infiltration (I/I).

- 1. Structural Analysis:** The structural condition of the existing sewer needs to be evaluated in order to determine if the pipe can be rehabilitated, or if complete replacement is necessary. If rehabilitation is a possibility, the existing condition of the pipe may determine the rehabilitation technique necessary.

A structural evaluation should begin by thoroughly cleaning the line by water jetting. This should be followed by a closed-circuit television (CCTV) inspection. The inspection should provide information on the location, type, size, and severity of each defect in the pipe. Defects, which may be identified, include broken sections, longitudinal or circumferential cracks, offset joints, collapses, and corroded sections. In addition to the structural defects, obstacles that might affect the rehabilitation process, such as roots or projecting laterals, should be identified during the televising process. The locations of service connections should also be noted during this process.

Manholes should be visually inspected to identify any significant cracks in the walls, deteriorated inverts, crumbling brick or concrete, or signs of chemical attack.

- 2. Capacity and Inflow and Infiltration Analysis:** A capacity analysis of the existing line should be conducted. The capacity of the existing line should be determined based upon the size and slope of the sewer. The computed sewer capacity should take into account any reduction in size due to the rehabilitation method selected. This computed capacity is compared against future projected sewer flows.

In order to determine future flows for sanitary sewers, current flows should be measured. These flows are measured at various times in order to determine maximum and minimum flows. In addition, the flows should be measured both during dry weather conditions and during high groundwater and heavy rain conditions in order to identify potential I/I problems.

I/I flows come from several sources. Inflow is water which is dumped into the sanitary sewer system through improper connections, such as downspouts or sump pumps. Infiltration is caused by water leaking into the system through pipe joints, openings in manholes, and other sources. I/I of storm water and groundwater into the sanitary sewer cause unnecessarily high sewer loading at the wastewater treatment plant. These high flows increase treatment costs and reduce the effective capacity of the plant.

Significantly increased readings (compared to those for dry weather) during periods of high groundwater indicate that infiltration is occurring. Sharp flow peaks during rainfall events indicate inflow into the sewer. While rehabilitating the line will likely reduce the amount of infiltration that is occurring, it will do little to cut the amount of inflow. In situations where inflow is identified as a problem, further investigation, such as smoke testing, is warranted to identify the sources of inflow and eliminate them.

After completing the flow monitoring process, future flows are calculated by adjusting the current measured flows for anticipated population growth and increased industrial and commercial usage.

The sewer line should be checked to verify that it has sufficient capacity to carry future flows for the projected life of the rehabilitation.

C. Selection of a Rehabilitation Technique

Based upon the results of the existing system evaluation, a proper rehabilitation technique should be selected. If the condition and capacity of the existing pipe do not require removal and replacement, an appropriate rehabilitation method, as described in the following sections, should be selected.

Pipeline Rehabilitation

A. Cured-in-place Pipe (CIPP)

1. **Description of Process and Materials:** One of the most widely used pipeline rehabilitation methods is the cured-in-place pipe (CIPP) lining method. The CIPP process begins by thoroughly cleaning the existing pipeline, removing any debris or protruding laterals, noting locations of existing lateral connections, and diverting sewer flows, if they are high, in preparation for the installation of the liner.
 - a. **Liner:** The liner consists of an absorbent, flexible, industrial grade felt tube with an impermeable membrane on the inside surface. The size and length of the tube are custom made to fit each project. This makes CIPP an ideal method for odd sized or odd shaped pipes such as old brick sewers.
 - b. **Resin:** As mentioned above, the resin is what hardens and ultimately gives the CIPP its strength. Various resins are available and each has different properties. The material property, of most interest to the designer in determining the thickness of the liner to be installed, is the strength or flexural modulus of elasticity. Resins with a flexural modulus of 250,000, 300,000, and 400,000 psi are common. Additional resin strengths may be available; it is recommended that a CIPP supplier be contacted to determine the currently available resins.

Over time, the materials used for construction of CIPP will undergo deformation when exposed to a constant load. This deformation is defined as creep. This long term creep effectively reduces the strength of the liner over time. To account for this, a reduction factor (normally 50%) is applied to the initial flexural modulus of the resin material to provide a long term modulus of elasticity (E_L). This long term modulus is the value utilized in the liner designs discussed in the following sections on design.

- c. **Preparation for Lining:** Prior to beginning the lining process, the sewer should be thoroughly cleaned and televised. All service connection locations should be identified and carefully noted. Large pieces of debris such as bricks or chunks of concrete should be removed. Any obstructions that may interfere with the lining process, such as protruding services, severely offset joints, collapsed pipes, tree root penetration, etc., should be addressed by either remote repair or by open cut point repair.
 - d. **CIPP Installation Process:** Just before delivery to the project site, the felt tube is thoroughly wetted with a thermosetting resin. As the resin is applied to the felt, the liner is turned inside-out, resulting in the impermeable membrane being on the outside, and the resin-impregnated felt on the inside of the tube. The liner is loaded on a truck and delivered to the project. Since the resin cures in the presence of heat, the liner may be shipped in a refrigerated truck or packed in ice if weather conditions dictate.

Figure 14C-2.01: Typical CIPP Inversion Process

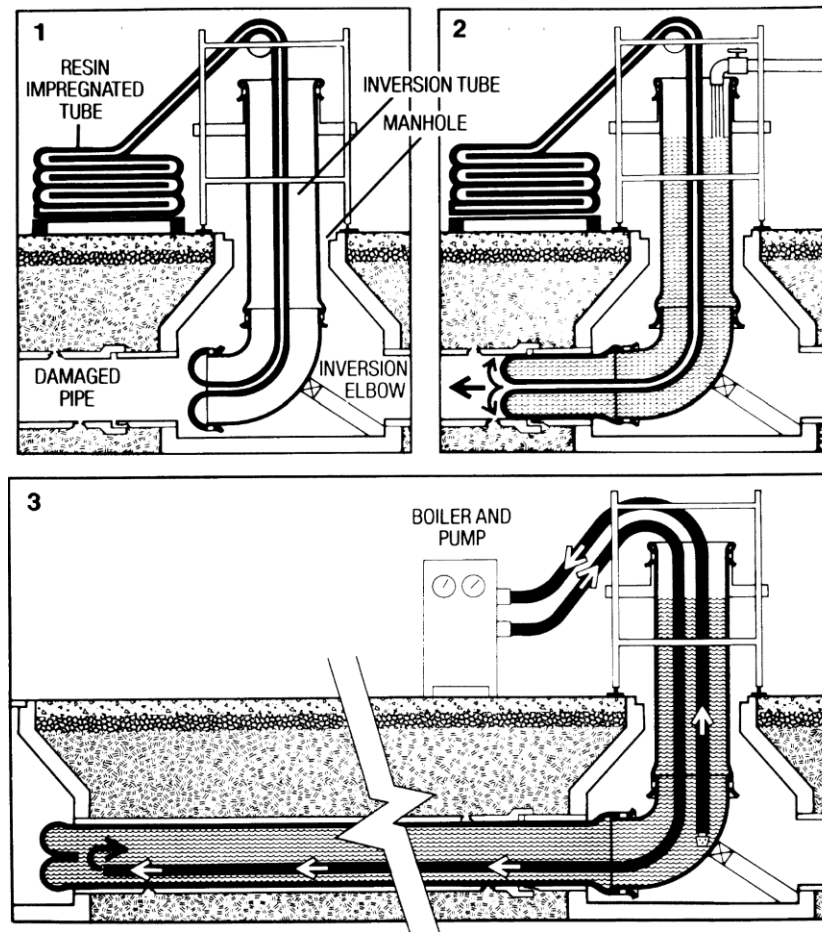

Source: Iseley and Najafi, 1995, from Insituform

The sewer is lined by inverting the tube into the sewer line. In the inversion process, one end of the tube is cuffed back and attached to an inversion ring directly above the access point (typically a manhole). The inverted tube is filled with water. The resulting pressure head is used to force the liner through the sewer line and continue the inversion process. In addition to inverting the tube, the water head also acts to expand the tube inside the pipe, forcing the resin soaked felt (once again on the outside of the liner) against the inside walls of the existing sewer pipe. The pressure head applied by the water causes some of the resin in the felt to be squeezed out, filling leaky joints and cracks in the pipe. ASTM F 1216 addresses this potential loss of resin from the felt tube by requiring an additional 5 to 10% (by volume) of resin to be added to the tube beyond its saturation point.

Rather than inverting with water pressure as described above, CIPP liners can also be pulled into place by a winch and then expanded. When the pulled-in-place process is utilized, the membrane remains on the outside of the liner during the entire process. This membrane may remain impermeable or be perforated or slotted prior to installation (this should be specified in the plans). Even though the liner may be perforated or slotted during the installation process, the exterior liner can inhibit the migration of the resin from the liner into joints and cracks.

While the pulled-in-place installation method can be successfully utilized, the inversion method may be better suited for pipelines that have high levels of infiltration through the pipe joints or cracks. The pulled-in-place and inversion methods work equally well for lining pipes whose defects are more structural in nature.

- e. **Curing and Hardening the CIPP Liner:** Regardless of the method of installation, the newly installed liner is then cured by applying heat. Typically, this is done by heating and circulating the water used to invert and expand the tube, or by applying pressurized steam to the line. The applied heat causes the thermosetting resin in the felt to cure or harden. This changes the resin from a liquid to a solid. After the resin has cured, the CIPP is cooled, resulting in a new pipe with a slightly smaller inside diameter, but of the same general shape as the original pipe.
- f. **Completion:** The ends of the CIPP are trimmed off, and the service laterals are reopened. Reopening the service connections can be done by man-entry for larger diameters or robotically for smaller diameters. Normally, a small dimple is left in the liner directly over each service connection, allowing them to be easily located and reopened. However, the number and locations of the service connections should be noted during the pre-lining televising process to ensure that all connections are reopened and to aid in locating those that are difficult to identify.

The result of the CIPP process is that a new pipe is formed within the existing sewer pipe. This new pipe reduces infiltration and adds structural integrity to the existing line. The expected service life of a cured-in-place liner is generally accepted to be 50 years.

2. **CIPP Design:** Cured-in-place pipe liners should be designed in accordance with ASTM F 1216 – "Standard Practice for Rehabilitation of Existing Pipelines and Conduits by the Inversion and Curing of a Resin-Impregnated Tube." This standard is recognized by virtually all CIPP suppliers and contractors. The standard for the CIPP is all inclusive, covering material requirements, construction methods, and design parameters. The equations and definitions utilized in this section are taken from ASTM F 1216.

The first step in designing a CIPP project is identifying the condition of the existing pipe. ASTM F 1216 divides existing pipe conditions into two classes: partially deteriorated condition and fully deteriorated condition. The condition of the pipe affects the method of design that is utilized. According to ASTM F 1216, these conditions are defined as follows:

"Partially deteriorated pipe - the original pipe can support the soil and surcharge loads throughout the design life of the rehabilitated pipe. The soil adjacent to the existing pipe must provide adequate side support. The pipe may have longitudinal cracks and up to 10% distortion of the diameter. If distortion of the diameter is greater than 10%, alternative design methods are required" (see fully deteriorated pipe).

"Fully deteriorated pipe - the original pipe is not structurally sound and cannot support soil and live loads nor is expected to reach this condition over the design life of the rehabilitated pipe. This condition is evident when sections of the original pipe are missing, the pipe has lost its original shape, or the pipe has corroded due to the effects of the fluid, atmosphere soil or applied loads."

- a. Design for Partially Deteriorated Gravity Pipe Condition:** Generally, the partially deteriorated condition is used when the existing pipe is in good condition, but has leaky joints. For this reason, the liner is only designed to resist the hydrostatic loads due to groundwater, since the soil and live loads are still being supported by the original pipe. The required thickness of the liner is determined utilizing the following equations:

$$t = \frac{D_o}{\left[\frac{2KE_L C}{P_w(1-v^2)N} \right]^{1/3} + 1} \quad \text{Equation 14C-2.01}$$

(Note: this is a rearrangement of Equation X1.1 from ASTM F 1216)

where:

- t = CIPP thickness, inches
 D_o = Mean outside diameter of the CIPP, inches
 K = enhancement factor of the soil and existing pipe, typically 7 (conservative), dimensionless
 E_L = long term (time corrected) modulus of elasticity for CIPP, psi (see Section 14C-2, A, 1, b)
 P_w = groundwater load (hydrostatic pressure), psi

$$P_w = \frac{H_w(\text{ft}) \times 62.4(\text{pcf})}{144\left(\frac{\text{in}^2}{\text{ft}^2}\right)} \text{ or } P_w = 0.433(H_w) \quad \text{Equation 14C-2.02}$$

- H_w = Groundwater height above the top of the pipe, ft
 v = Poisson's ratio (0.3 average), dimensionless
 N = factor of safety (normally 2.0), dimensionless
 C = ovality reduction factor, dimensionless. See Table 14C-2.03, or

$$C = \left(\frac{\left[1 - \frac{q}{100} \right]}{\left[1 + \frac{q}{100} \right]^2} \right)^3 \quad \text{Equation 14C-2.03}$$

- q = percent ovality of original pipe - estimate from the CCTV inspection the amount of ovality (deflection from original round shape). Normally, the ovality will vary along the length of the line (use the most oval condition). The more ovality, the thicker the liner will need to be.

Table 14C-2.01: Ovality Reduction Cactor (based upon Equation 14C-2.03)

Ovality, q, %	Factor, C	Ovality, q, %	Factor, C
0	1.00	12	0.35
2	0.84	14	0.29
4	0.70	15	0.27
5	0.64	16	0.24
6	0.59	18	0.20
8	0.49	20	0.17
10	0.41		

If the groundwater table is below the invert of the pipe, the hydrostatic pressure is zero, and Equation 1 cannot be used to calculate the liner thickness. If it is determined that the CIPP will not be underwater, ASTM F1216 recommends a CIPP with a maximum standard dimension ratio (SDR) of 100. When there are no external hydrostatic forces on the pipe, the CIPP thickness is calculated with Equation 14C-2.04:

$$t = \frac{D_o}{100} \quad \text{Equation 14C-2.04}$$

where:

$$\begin{aligned} t &= \text{CIPP thickness, inches} \\ D_o &= \text{Mean outside diameter of the CIPP, inches} \end{aligned}$$

When the existing host pipe is out of round or is deformed in a localized area, bending stresses may be the predominant force action on the CIPP when external hydrostatic pressure surrounds the pipe. When the host pipe is oval, the CIPP must be checked to ensure that bending stresses do not exceed the long term flexural strength of the CIPP. This value should be available from the liner supplier. The bending stresses that the pipe is expected to see over its life are given by Equation 14C-2.05 below.

$$\left[\frac{1.5q}{100} \left(1 + \frac{q}{100} \right) \left(\frac{D_o}{t} \right)^2 - 0.5 \left(1 + \frac{q}{100} \right) \left(\frac{D_o}{t} \right) \right] P_w N = \sigma_L \quad \text{Equation 14C-2.05}$$

where,

$$\begin{aligned} \sigma_L &= \text{long term flexural strength of the CIPP, psi} \\ q &= \text{percentage of ovality of the original pipe, \%} \\ D_o &= \text{mean outside diameter of the CIPP, inches} \\ t &= \text{CIPP thickness, inches} \\ P_w &= \text{external water pressure, psi (see Equation 14C-2.02)} \\ N &= \text{factor of safety (normally 2.0), dimensionless} \end{aligned}$$

- b. Design for Fully Deteriorated Gravity Pipe Condition:** Generally, the fully deteriorated condition is chosen when the existing pipe is showing signs of significant deterioration. The liner pipe is expected to carry all of the hydraulic, soil, and live loads by itself, as if the host pipe were not present. The fully deteriorated liner design is begun by determining the anticipated external loading on the liner:

Hydrostatic pressure:

P_w - See Equation 14C-2.02 in the preceding section.

Soil pressure:

Soil pressure is estimated by determining the prism load, P_s , acting on the pipe. This load is determined as follows:

$$P_s = \frac{\omega H_s R_w}{144} \quad \text{Equation 14C-2.06}$$

where,

- P_s = Soil prism loading pressure, psi
- ω = Soil density, lb./ft³
- H_s = Height of soil above top of pipe, feet
- R_w = Water buoyancy factor, dimensionless

$$R_w = 1 - 0.33 \left(\frac{H_w}{H_s} \right) \quad (\text{minimum value} = 0.67) \quad \text{Equation 14C-2.07}$$

- H_w = water height above the top of the pipe, feet
- H_s = soil height above the top of the pipe, feet

Live load:

Live load exerted by traffic, railroads, aircraft, or from other sources should be calculated. Typical values are shown in Table 14C-2.02.

Table 14C-2.02: Live Load Pressures at Various Depths

Height of fill (feet)	Highway HS-20 (psi)	Railroad Cooper E-80 (psi)	Airport ¹ (psi)	
			Rigid Pavement	Flexible Pavement
1	16	19	10	59
2	7	18	9	30
3	3	16	8	23
4	2	14	8	16
5	2	12	7	12
6		10	6	10
8		8	5	7
10		6	4	5
15		4		
20		2		

¹ 180,000 Pound Dual-Tandem Gear Assembly, 190 psi tire pressure, 26 inch c/c spacing between dual tires, 66 inch c/c spacing between fore and aft tandem tires.

Table values developed from American Concrete Pipe Association, Concrete Pipe Design Manual, 2000

Total external pipe load:

$$P_t = P_w + P_s + P_L \quad \text{Equation 14C-2.08}$$

where,

- P_t = Total external pipe load, psi
- P_w = Hydrostatic pressure, psi
- P_s = Soil pressure, psi
- P_L = Live load, psi

Once the total external load that the liner pipe must support has been determined, the liner thickness can be determined with Equation 14C-2.09.

$$t = \left[\frac{0.375 \left(P_t \frac{N}{C} \right)^2 D_o^3}{E_L R_w B' E'_s} \right]^{1/3} \quad \text{Equation 14C-2.09}$$

(Note: this is a rearrangement of Equation X1.3 from ASTM F 1216)

where:

- t = CIPP thickness, inches
- P_t = Total pressure due to water, soil, and live load acting on CIPP, psi
- N = factor of safety (normally 2.0), dimensionless
- C = ovality reduction factor, dimensionless. See Table 14C-2.01, or Equation 14C-2.03
- D_o = Mean outside diameter of the CIPP, inches
- E_L = long term (time corrected) modulus of elasticity for CIPP, psi (see Section 14C-2, A, 1, b)
- R_w = Water buoyancy factor, dimensionless (see Equation 14C-2.07)
- B' = Empirical coefficient of elastic support, dimensionless

$$B' = \frac{1}{1 + 4e^{-0.065H_s}} \quad \text{Equation 14C-2.10}$$

e = base of natural log = 2.718

- H_s = soil height above top of pipe, feet
- E'_s = Modulus of soil reaction, psi (see note below)

While most of the terms utilized in Equation 14C-2.09 should be known or could be calculated, the Modulus of Soil Reaction is a relatively subjective term. This is a variable that is used to reflect the amount of support being given to the new liner pipe from the surrounding soil. Since the surrounding soil is actually the host pipe, this value can be hard to determine. Use judgment after viewing the CCTV video of the sewer. Badly cracked pipe, missing bricks, and missing pipe are reasons to thicken the liner. Values to be used are between 500 psi (bad pipe, thick liner) and 2,000 psi (fair pipe, thinner liner).

For shallow pipes with little or no groundwater to contribute to the load, a minimum thickness check should be completed. This is a similar design condition as previously described for partially deteriorated pipe having no groundwater. For this special case, there is a provision in ASTM F 1216 that requires the CIPP to have a minimum pipe stiffness that is 1/2 that of the value specified in AWWA C950. Based upon this requirement, the minimum pipe thickness is checked by the following equation:

$$t \geq (D_o) \left(\sqrt[3]{\frac{1.116}{E}} \right) \quad \text{Equation 14C-2.11}$$

where:

- t = CIPP thickness, inches
- D_o = Outside diameter of CIPP
- E = initial modulus of elasticity for CIPP

One final check of the design needs to be completed. As described for partially deteriorated pipe in the preceding section, the bending stresses need to be checked for pipes which are out of round. The bending stresses that a fully deteriorated pipe is expected to see over its life are calculated in the same manner as for a partially deteriorated pipe and are given by Equation 14C-2.05.

3. Project Considerations:

- a. **Contractor Review:** Prior to bidding any CIPP project, it is always a good idea to review the project with an experienced CIPP contractor. There are construction and performance related limitations to the use of CIPP for pipeline rehabilitation. These limitations relate to the condition of the existing pipeline, the maximum practical thickness of the liner, and the point where CIPP lining is no longer a cost effective option. The contractor may be able to recommend alternatives to reduce the cost or improve the performance of a CIPP liner.

Before designing a project with unusual conditions (odd-shaped pipe, deep pipe, severely deteriorated pipe, difficult access, etc.), it may also be wise to meet with a local CIPP installation contractor, visit the site, and review the sewer tapes with the contractor.

- b. **Preparing Contract Documents for a CIPP Project:** One of the most important things to consider when designing a CIPP liner and preparing the contract documents for the project is that there are a variety of different strength resins available. These different resins can be used in conjunction with different thicknesses of felt to produce multiple liner designs, which meet the requirements of a particular project. The point is to find the combination of resin strength and liner thickness that meets the requirements of the project and has the lowest cost.

For this reason, a single resin strength / liner thickness should not normally be specified on a particular project. Rather, multiple resin strengths / liner thicknesses should be allowed. The combination of resin and liner that is the most economical for one contractor may be different than that of another contractor.

There are two different ways to allow each contractor the flexibility of selecting their own resin/liner combination while assuring that the product being bid meets the requirements of the job. The first method is to allow the contractor to design the liner thickness themselves. If this is done, the engineer should state on the plans that the liner shall be designed in accordance with ASTM F 1216 (or F 1743 if pulled-in-place installation is allowed). In

addition, the engineer should require that each potential bidder submit their calculations prior to the letting for review. During this review, the engineer should verify that all bidders are using the same design criteria, and that this criterion matches the site conditions. The alternative method for specifying a liner is to give various combinations of resin and liner thicknesses, allowing the contractor to select the one that is most economical. This method requires the engineer to calculate several liner thicknesses for different resins, but eliminates the possibility that a contractor may use an incorrect value or make an error in their calculations. Typical information provided in the plans is shown in Table 14C-2.03.

Table 14C-2.03: Typical Plan Information for a CIPP Project
(Partially deteriorated condition)

Between Manholes	Length, (ft)	Pipe Dia., in	Water above Pipe H_w , ft	Ovality Factor, C	Safety Factor, N	Min. liner thickness, in		
						E_L (psi) = 125,000	E_L (psi) = 150,000	E_L (psi) = 200,000
41 to 47	1100	12	12	.64	2.0	.240	.226	.205

Table 14C-2.04: Typical Plan Information for a CIPP Project
(Fully deteriorated condition)

Between Manholes	Length, (ft)	Pipe Dia., in	Live Load P_L , psi	Total Load P_T , psi	Water Buoyancy Factor R_w	Water above Pipe H_w , ft	Soil above pipe H_s , ft	Coeff. Of Elastic Support, B'	Ovality Factor, C	Safety Factor, N	Modulus of Soil, E_s , (psi)	Min. liner thickness, in		
												E_L (psi) = 125,000	E_L (psi) = 150,000	E_L (psi) = 200,000
41 to 47	1,100	12	2.0	6.5	.87	2	5	.257	.64	2.0	1,000	.211	.199	.181
47 to 173	1,600	12	7.6	14.8	.88	3	8	.296	.84	2.0	500	.366	.345	.313

The CCTV video of the sewer to be lined should be made available to any potential bidders for review prior to the bid. The contract documents can state that a video is available for viewing and who to contact to arrange a time to view the video, or copies of the video can be distributed to each potential bidder along with the contract documents.

Any time restrictions or additional requirements of the work should be clearly spelled out in the contract documents. These include bypass pumping requirements, time restrictions such as night or weekend work, coordination with other projects, etc. In addition, the contract documents should indicate what testing of the liner will be required.

- c. **Testing:** ASTM F 1216 and F 1743 both address the testing requirements for CIPP linings. When specified by the owner, these specifications require the contractor to prepare samples in one (or both when specified) of two ways. The first is to cut a section of the cured CIPP from the liner where it passes through an intermediate manhole or from the terminating end of the CIPP liner. Alternatively, a section of the uncured liner, which is made of the same felt and resin as the liner, can be bolted into a frame and placed inside the pipe during the curing process.

The samples provided may be tested for short-term flexural (bending) properties and delamination. In addition, exfiltration testing for sewer lines 36 inches and smaller, which do not have any service laterals, may also be required.

- d. Costs:** The main concern with CIPP is normally the cost. Depending on the situation, the cost for a CIPP liner may approach or exceed that for open cut removal and replacement. However, one must consider the main reason for considering a trenchless technique in the first place (reduced disruption to the public). The disruption caused by CIPP lining is minimal (the process can often be completed with no excavation of any kind required).

There are several recommendations for reducing the costs associated with a CIPP lining project. The first is to avoid lining small quantities of pipe. Lining large quantities (1,000 feet or greater) under a single project significantly reduces the unit cost of CIPP lining. One of the most significant costs involved with the lining process is mobilization of people and equipment. If two or three separate lines are being considered for lining, it is much more cost effective to do them all as a single project than to do them each separately. Check with surrounding communities to see if they are planning any lining projects that could be combined and let together. This allows the contractor to install two projects with only one mobilization cost.

The second recommendation is to allow a large time frame for a lining project. Most CIPP contractor's territories cover large portions of the country. Providing a flexible time frame allows the contractor to schedule and complete several projects in a particular area at the same time. Again, this reduces mobilization costs.

Also consider other rehabilitation methods which may be less expensive. For larger pipe (>42 inches), sliplining may be more economical if the line has sufficient capacity to account for the reduced cross section created by the sliplining process.

4. CIPP Design Examples:

Figure 14C-2.02: Partially Deteriorated Design Example

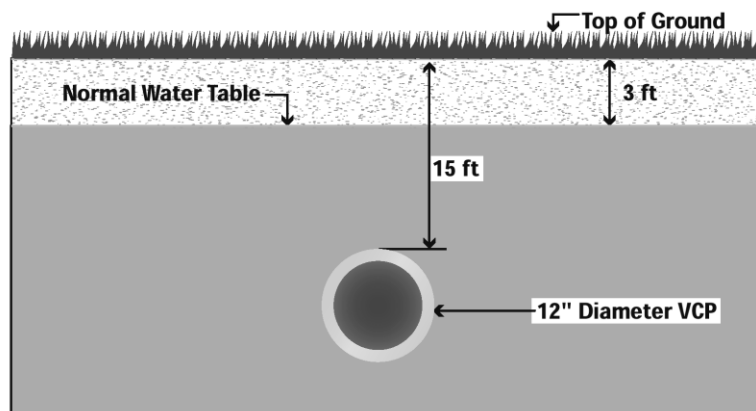

Source: Inliner Technologies

Given: A partially deteriorated 12 inch diameter sanitary sewer pipe with some cracking and offset joints is leaking and in need of renewal (see Figure 14C-2.02). Through CCTV inspection, it appears that in at least one area, the pipe is no longer round and has deflected approximately 5 percent. The water table, through investigation, is found to normally be at 3 feet below the surface. The pipe is buried at a depth of 15 feet to the top of the pipe. Assume a modulus of

elasticity for the resin of 300,000 psi (long term modulus, $E_L = 0.5(300,000) = 150,000$ psi) and a long term flexural strength of 2,500 psi.

Required: Determine the wall thickness required for a CIPP liner.

Solution:

Step 1: Determine the hydrostatic pressure acting on the CIPP

$H_w = 15'$ (pipe depth) - $3'$ (depth of water table) = $12'$

$$P_w = \frac{12(\text{ft}) * 62.4(\text{pcf})}{144\left(\frac{\text{in}^2}{\text{ft}^2}\right)} = 5.2\text{psi} \quad \text{From Equation 14C-2.02}$$

Step 2: Pipe ovality

From Table 14C-2.01 or Equation 14C-2.03, $C = 0.64$

Step 3: Determine the CIPP design thickness from Equation 14C-2.01

$$t = \frac{D_o}{\left[\frac{2KE_L C}{P_w(1-\nu^2)N} \right]^{1/3} + 1} = \frac{12}{\left[\frac{2(7)(150,000)(0.64)}{(5.2)(1-0.3^2)(2)} \right]^{1/3} + 1} = 0.226 \text{ Inches}$$

Step 4: Because the pipe has some out-of-roundness, bending stresses must be calculated to ensure they do not exceed the long-term flexural strength of the CIPP. From Equation 14C-2.05:

$$\sigma_L = \left[\frac{1.5(5)}{100} \left(1 + \frac{5}{100} \right) \left(\frac{12}{.226} \right)^2 - 0.5 \left(1 + \frac{5}{100} \right) \left(\frac{12}{.226} \right) \right] 5.2(2) = 2020 \text{ psi}$$

Since the long term bending stress of 2,020 psi is less than the long term flexural strength of the product, the initial design is OK. However, if the bending stresses had exceeded the long term flexural strength, then the bending stresses would control the thickness design and Equation 14C-2.05 would need to be solved for thickness.

Figure 14C-2.03: Fully Deteriorated Design Example

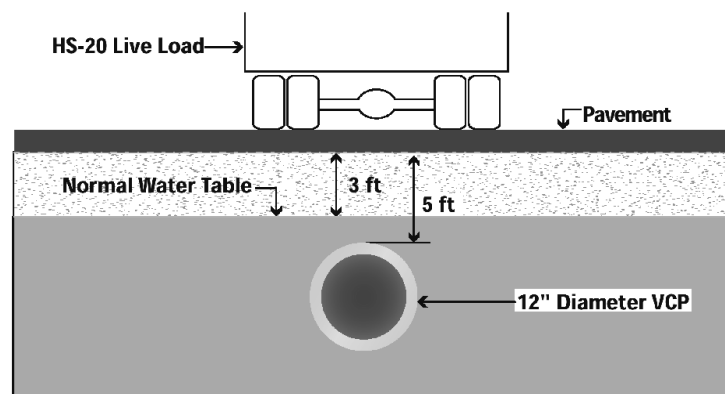

Source: Inliner Technologies

Given: The 12 inch VCP sanitary sewer pipe shown in Figure 14C-2.03 is cracked and leaking. The severity of the cracking has progressed to the point that some pieces of the pipe wall have fallen into the pipeline and voids have begun to form around the pipe. The pipe is shallow and located under a busy city street subject to HS-20 loading. Assume that the pipe is buried under a clay soil with a unit weight of 120 pcf. As in the previous example, the pipe is no longer round and has deflected approximately 5%. The water table is normally located 3 feet below the surface. Assume a modulus of elasticity for the resin of 300,000 psi (long term modulus, $E_L = 0.5(300,000) = 150,000$ psi), a long term flexural strength of 2,500 psi, and a soil modulus of 1,000 psi.

Required: Determine the wall thickness required for a CIPP liner.

Solution:

Step 1: Determine the total load, P_t , acting on the pipe above.

$$\text{Hydrostatic Pressure: } P_w = \frac{2(\text{ft}) * 62.4(\text{pcf})}{144\left(\frac{\text{in}^2}{\text{ft}^2}\right)} = 0.87 \text{ psi} \quad \text{From Equation 14C-2.02}$$

$$\text{Soil Load: } R_w = 1 - 0.33\left(\frac{2}{5}\right) = 0.87 \text{ (min. = 0.67)} \quad \text{From Equation 14C-2.07}$$

$$P_s = \frac{(120)(5)(0.87)}{144} = 3.63 \text{ psi} \quad \text{From Equation 14C-2.06}$$

Live Load: From Table 14C-2.02, the live load at 5 feet for HS-20 loading = 2 psi

Total Load:

$$P_t = 0.87 + 3.63 + 2 = 6.5 \text{ psi} \quad \text{From Equation 14C-2.08}$$

Step 2: Determine the coefficient of elastic support

$$B' = \frac{1}{1 + 4e^{-0.065(5)}} = 0.26 \quad \text{From Equation 14C-2.10}$$

Step 3: Pipe ovality and ovality reduction factor

From Table 14C-2.01 or Equation 14C-2.03, $C = 0.64$

Step 4: Determine the CIPP thickness from Equation 14C-2.09

$$t = \left[\frac{0.375 \left(P_t \frac{N}{C} \right)^2 D_o^3}{E_L R_w B' E'_s} \right]^{1/3} = \left[\frac{0.375 \left(6.5 \frac{2}{0.64} \right)^2 12^3}{(150,000)(0.87)(0.26)(1,000)} \right]^{1/3} = 0.199 \text{ inches}$$

Step 5: Minimum thickness check from Equation 14C-2.11

$$t \geq (D_o) \left(\frac{1.116}{E} \right)^{\frac{1}{3}} = 12 \left(\frac{1.116}{300,000} \right)^{\frac{1}{3}} = 0.186 \text{ Inches}$$

Since the design thickness calculated in Step 4 is greater than the minimum thickness given in Step 5, the calculated design thickness is OK.

Step 6: Bending stress check from Equation 14C-2.10

$$\sigma_L = \left[\frac{1.5(5)}{100} \left(1 + \frac{5}{100} \right) \left(\frac{12}{0.20} \right)^2 - 0.5 \left(1 + \frac{5}{100} \right) \left(\frac{12}{0.20} \right) \right] (0.4)(2) = 204 \text{ psi}$$

The calculated bending stress (204 psi) is less than the allowable long-term flexural strength of the product (2,500 psi). If the bending stresses had exceeded the long term flexural strength, then the bending stresses would control and Equation 5 would need to be solved for thickness.

B. Fold-and-formed Pipe (FFP) and Deformed Reformed Pipe (DRP) Lining

The fold-and-formed pipe (FFP) and deformed-reformed pipe (DRP) techniques are pipeline rehabilitation methods that were once common, but are seeing decreased usage today. FFP and DRP are both names for a process which consist of folding or deforming a circular polyethylene (PE) or Poly Vinyl Chloride (PVC) pipe into a "U" shape during the time of manufacture, to reduce the cross sectional area of the pipe. The deformed pipe is then coiled on a spool for transport.

At the project site, the coiled pipe is pulled into the existing pipe. The reduced cross section of the folded pipe allows it to fit inside of the host pipe. At this point, steam or hot water is circulated through the pipe to heat it until it becomes pliable. The pipe is then rounded utilizing steam or water pressure, or by pulling a rounding device through the pipe. The pipe is then allowed to cool and harden in place. Service laterals are then reopened robotically or by digging them up and re-establishing them.

As mentioned above, use of the FFP/DRP method is declining, especially in the northern climates. This is due, at least in part, to problems encountered with the pipe developing a "memory" during the deformation process. Over time, the rounded pipe starts to return to its original deformed shape. The action appears to be accelerated by the cold weather conditions experienced in the northern states. This can cause the liner to pull away from the host pipe, reducing support and separating from service laterals.

Given the declining usage of the FFP/DRP process, the design and construction process is not discussed in detail herein. Should the designer wish to pursue a FFP/DRP project, the following ASTM references are provided:

- F 1504 Standard Specification for Folded Poly Vinyl Chloride (PVC) Pipe for Existing Sewer and Conduit Rehabilitation
- F 1947 Standard Practice for Installation of Folded Poly Vinyl Chloride (PVC) Pipe into Existing Sewers and Conduits
- F 1871 Standard Specification for Folded/Formed Poly Vinyl Chloride Pipe Type A for Existing Sewer and Conduit Rehabilitation

- F 1867 Standard Practice for Installation of Folded/Formed Poly Vinyl Chloride (PVC) Pipe Type A for Existing Sewer and Conduit Rehabilitation
- F 1533 Standard Specification for Deformed Polyethylene (PE) Liner
- F 1606 Standard Practice for Rehabilitation of Existing Sewers and Conduits with Deformed Polyethylene (PE) Liner

C. Sliplining

1. **Description of Process and Materials:** The concept of sliplining is one of the simplest techniques for rehabilitating an existing sewer line. Sliplining basically involves pushing or pulling a new pipe into the old one, reconnecting the services, and possibly grouting the space between the pipes.

Figure 14C-2.04: Typical Sliplining Installation

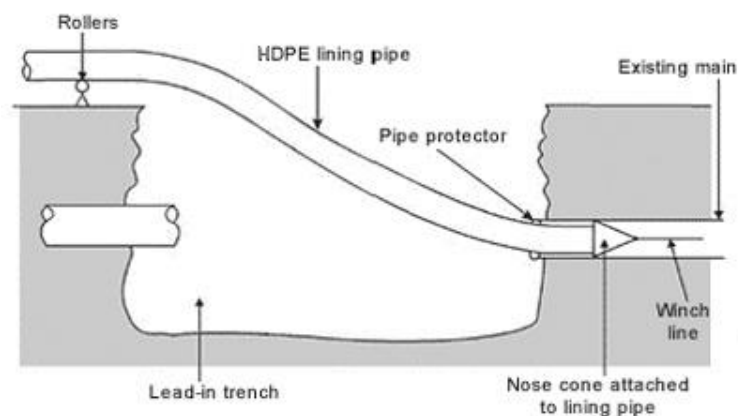

Source: PROFUNDIS Presse

- a. **Polyethylene Pipe:** The most common material used for sliplining is polyethylene (PE) pipe. Its ability to be fusion welded into long jointless sections, which can be quickly pulled into place, make it a popular choice for sliplining.

The process of sliplining with PE pipe begins by excavating a starter trench at one end of the line. This trench allows the pipe to be pulled from the ground surface into the pipe without requiring sharp bends. Prior to installation, individual sections of PE pipe are fusion welded together to form a single continuous section of pipe that matches the length of the pipe to be lined. This pipe is laid out in a long line on the ground surface. At this point, sewer flows must be diverted. A cable is fed through the host pipe and attached to a towing head. This towing head is attached to the end of the new liner pipe and the liner is pulled into place with a winch. After the pipe has been pulled into place, the annular space between the host pipe and the lining pipe is normally filled with grout. Grouting this space helps to restrain the liner pipe and increases its stiffness. This can be the most difficult part of a sliplining project. Finally, any service lines must be reconnected. These lines cannot normally be reconnected from inside the pipe like CIPP lining. The connections must be excavated and a new wye installed on the lining pipe.

There are several disadvantages to sliplining with PE pipe. The first is that the pipe stretches under the high tensile forces developed during the installation process. After the pipe is in place and the tensile forces are relieved, the pipe slowly shrinks back to its original shape. This can cause problems if service lines are re-established before the liner pipe has had a chance to relax. If a service connection is re-opened in the liner pipe too soon, the liner pipe

will shrink, and the opening in the liner will move past the connection, creating a blockage. It is generally recommended that the liner pipe be allowed at least 24 hours to relax prior to reestablishing service connections. This may require the establishment of temporary services.

Since most polyethylene pipe used for sliplining is black in color (to protect it from ultraviolet degradation) it is a common practice to specify that the pipe be lined with a light colored material to facilitate future CCTV inspection.

- b. Other Materials:** As indicated above, sliplining pipe is most commonly polyethylene; however, it may be any common sewer material that can be inserted into the host pipe. The main criteria is that, in order to minimize the reduction in cross sectional area of the pipe, joints or socket protrusions beyond the barrel of the pipe should be minimized or eliminated. Fortunately, there are a wide variety of pipe products that meet this criterion. Most are intended for pipe jacking, microtunneling, or directional boring; however, their bell-less or low profile bell configurations also make them well suited for sliplining.

Rigid products such as vitrified clay, concrete, ductile iron, and centrifugally-cast glass-fiber reinforced polymer mortar (CCFRPM) pipe can all be pushed into the pipe from a relatively small access pit. These products are pushed into the pipe utilizing jacking equipment similar to that for microtunneling or pipe jacking. Flow bypassing is not normally required since the line remains open during the insertion process. In addition, due to the inherent structural integrity of these rigid pipe products, grouting the annular space is not as critical as for flexible pipe; however, it is still normally done in order to lock the pipe in place.

Additional pipes products with restrained joints, such as PVC or ductile iron, can also be pulled into the line in a manner similar to that for PE pipe. These materials are usually installed a section at a time, rather than being completely assembled prior to installation like polyethylene. Again, flow bypassing is not normally required. Grouting of the annular space is not required for ductile iron and is optional for PVC depending on the condition of the original pipe.

2. Additional Considerations:

- a. Limitations:** Probably the biggest issue to contend with when considering a sliplining project is the reduction in pipe diameter that will result. Since the sliplining pipe must fit inside of the host pipe, the outside diameter of the lining pipe should be slightly smaller than the inside diameter of the host pipe at its narrowest point. The capacity of the smaller diameter liner pipe must be checked to verify that it can carry future anticipated flows. If sliplining the pipe causes too much of a reduction pipe capacity, alternative rehabilitation methods such as pipe bursting or CIPP may be considered.

For large diameter pipes (42 inches and greater), it may be possible to reestablish services by man-entry in the pipe; however, in most cases, the service connections must be excavated and re-established.

- b. Cost:** Sliplining is a relatively cost effective method of rehabilitation, especially for larger diameters. Many times, it may be the least costly method of pipeline rehabilitation. This is due in part to the relatively minimal equipment investment required and the commonly available materials utilized.

D. Pipe Bursting

1. **Description of Process and Materials:** Pipe bursting is a trenchless technique for replacing worn out and undersized pipes with a new pipe of the same or larger diameter. The pipe bursting process involves the insertion of a conical shaped bursting head into the old pipe. This head fractures the existing pipe and displaces the pipe fragments outward into the surrounding soil. At the same time, a new pipe is pulled in behind the bursting head. There are several different classes of pipe bursting systems. It should be noted that most of these systems are patented processes. Most contractors pay a licensing fee to be allowed to use the technique.
 - a. **Pneumatic Bursting:** Pneumatic pipe bursting is the most commonly used system for pipe bursting. This method utilizes a percussion head (similar to an impact mole) to fracture and break the pipe. In addition to the percussion force, cable is attached to the front of the mole and a winch provides tension to keep the bursting head pressed against the pipe wall and to aid in pulling the new pipe in behind the mole.

Figure 14C-2.05: Typical Pneumatic Bursting System

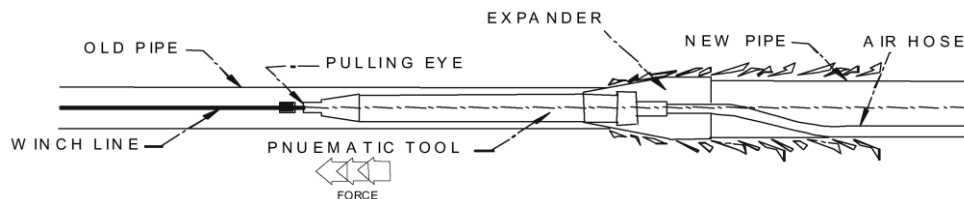

Source: Simicevic and Sterling

- b. **Hydraulic Expansion:** The hydraulic expansion system utilizes a bursting head, which can be expanded outward to break the existing pipe. In this process, the contracted head is pulled into the pipe. Hydraulic pressure is used to expand the head radially outward, breaking a section of the pipe, and pushing the fractured pieces into the surrounding soil. The head is then contracted and pulled forward with a winch, pulling in the new pipe behind it. This process is repeated in steps until the entire pipeline has been replaced.
- c. **Static Pull:** With the static pull method, the force for breaking and displacing the pipe comes only from pulling the bursting head forward. The cone shaped bursting head converts the horizontal tensile forces into radial forces that fracture the pipe. The tensile forces required to burst the existing pipe and pull in the new pipe are significant. For this reason, a pulling rod assemble may be used in lieu of a winch and cable system.
- d. **Implosion (Pipe Crushing):** The implosion system incorporates a crushing head, which fits around the outside diameter of the existing pipe. As the head is pulled forward, the crushing head breaks the existing pipe and forces the fragments inwards (into the pipe void). A steel cone follows the crushing head and pushes the pipe fragments outward, making room for the new pipe, which is pulled in behind the steel cone.
- e. **Pipe Splitting:** Pipe splitting is a method used for pipes that are not brittle, such as steel, ductile iron, and plastic. Rather than bursting the pipe, it is split open and expanded. This is accomplished with a three step process. Rotary splitter wheels make an initial longitudinal cut along the bottom of the pipe. Next, a hardened sail blade splits the pipe along the bottom. Finally, the pipe is “unwrapped,” or expanded, creating a hole immediately behind the splitter for the new pipe. The old pipe is displaced to a position immediately above the new pipe.

- f. Rigid Pipe Replacement Methods:** All of the methods previously described require the new pipe to be pulled in behind the bursting head. As a result, the new pipe must be flexible (typically polyethylene). There are methods available which allow the installation of rigid pipes (clay, ductile iron, concrete, GPMP, etc.) instead of polyethylene.

One method, based in part upon microtunneling techniques, utilizes jacks to push new sections of pipe in behind the breaking head. Another method utilizes a cable that is thread through the host pipe from the receiving pit to the launch pit and through the next section of pipe to be installed. The cable is attached to a pull plate on the end of the pipe furthest from the receiving pit. This causes the rigid pipe system to act as if it were being pushed instead of pulled.

- g. Pipe Removal Techniques:** Several other techniques, which result in removal of the existing pipe, are also available.
- 1) **Pipe Eating:** Pipe eating is a modified microtunneling system in which the existing pipe is crushed by the microtunneling head and, along with any excess soil, removed through the new pipeline by a slurry system. The new pipe is jacked in immediately behind the microtunneling machine. This system also allows line and grade adjustments to be made.
 - 2) **Pipe Reaming:** Pipe reaming is a modified version of the back reaming method used for directional drilling. A drill string is fed through the existing pipe and attached to a specially designed reaming head. The head is pulled back through the pipe as the reamer crushes and pulverizes the existing pipe. The pipe fragments and any excess soil required for upsizing are removed via a slurry system.
 - 3) **Pipe Ejection:** Pipe ejection uses modified pipe jacking techniques to remove the old pipe. The replacement pipe is placed against the old pipe and, as the new pipe section is jacked, the old pipe is pushed out into the reception pit. This method requires that the structural condition of the existing pipe be in sufficient condition to withstand the jacking forces produced.

2. Design Considerations:

- a. Range of Applications:** As previously mentioned, the types of pipe suitable for bursting are typically brittle materials such as vitrified clay, cast iron, asbestos cement, and plain concrete. Lightly reinforced or heavily deteriorated reinforced concrete pipe may also be able to be replaced by pipe bursting. Ductile iron, steel, and plastic are not suitable for pipe bursting, but can be replaced by pipe splitting.

The normal bursting length is between 300 and 400 feet, the typical distance between manholes. The size of the pipes currently being replaced by pipe bursting ranges from 2 to 36 inches and is increasing as bursting equipment and techniques are improved. The most common pipe replacement is size-for-size; however, the pipe can be upsized up to 3 pipe diameters or greater.

- b. Pipe Materials and Design:** Replacement pipes should be designed to withstand earth loads and live loads in the same manner as they would be for an open cut situation (see [Chapter 9, Part 9B](#)). For most installations, standard sewer or water main pipe materials with special restrained or bell-less joints are suitable. Installation forces are not normally a concern. Flexible pipes with restrained joints, intended for directional drilling and other trenchless construction, are designed to withstand high tensile forces, and are therefore suitable for the moderate tensile forces typically experienced during the pipe bursting process. Likewise, rigid bell-less pipes intended for pipe jacking and microtunneling are designed to withstand very high compressive forces and are, therefore, also suitable for pipe bursting.

While standard sewer and water materials may be used for pipe bursting, the most common pipe material utilized is polyethylene. The main benefits of polyethylene are its flexibility and ability to be fused into long sections. The wall thickness for PE pipe should be designed to withstand earth and live loads. Since polyethylene is softer than other pipe materials, it is more susceptible to damage by the broken fragment of existing pipe. For this reason, the design thickness is commonly increased by 10% to account for scarring of the outer surface. When polyethylene pipe is used, it is a common practice to specify that the pipe be made of or lined with a light colored material to facilitate future CCTV inspection.

- c. **Effect of Pipe Bursting on the Surrounding Environment:** All pipe bursting operations result in the displacement of soil. Even when the replacement is size for size, soil is displaced since the bursting head has a diameter greater than that of the replacement pipe. The soil expands in the direction of least resistance and can cause heaving at the surface. The amount of displacement depends on the degree of upsizing, the existing soil properties, and the depth of the bursting.

Heaving of the existing ground surface is most likely when the existing pipe is shallow or already large diameter pipes are upsized. The potential for heaving must be carefully considered, especially when bursting under existing pavements or structures.

In addition to heaving, adjacent utilities can also be affected by pipe bursting. In general, if there are deteriorated utilities within 2-3 pipe diameters of the bursting operation, there is potential for damage. Damage to adjacent services or structures can be minimized by creating a temporary excavation along the service or structure to protect it from the effects of the surrounding ground displacements.

- d. **Service Connections:** Prior to bursting, all service connections should be excavated and disconnected. The purpose of this is to provide a temporary service connection and to prevent the service line from being damaged by the bursting operation. If the replacement pipe is polyethylene, it is likely that the new pipe has been stretched during the installation process. Prior to reestablishing the service connections, the new pipe should be allowed to relax and return to its original shape for at least 24 hours.
3. **Cost and Comparison to Other Techniques:** Open cut replacement is normally preferred and more cost efficient than pipe bursting when the pipe is shallow and the excavation does not create a major inconvenience. When the depth of the existing pipe, and the resulting excavation required becomes a significant factor in the cost of replacement, pipe bursting may have a significant economic advantage over open cut replacement. Compared to other rehabilitation techniques, such as CIPP and sliplining, the main advantage of pipe bursting is that it does not result in a loss of capacity due to reduced pipe diameter and can significantly increase capacity by upsizing the line.

Manhole Rehabilitation

A. Introduction

Manhole deterioration is a problem that is becoming much more prominent as public infrastructure ages and the number of manholes in service increases. Concrete manholes are often susceptible to attack by sulfuric acid, which eats away at the concrete surface and eventually the steel reinforcing in the manhole, creating the potential for collapse. Brick manholes also deteriorate as the mortar joints are eaten away and begin to leak. Collapsing and leaking manholes require attention to avoid possible street collapses and other problems.

In certain circumstances, manhole rehabilitation, rather than replacement, may be a preferred option. Several rehabilitation techniques are described below. While many other rehabilitation techniques and products are available, the ones listed below are included in the SUDAS Specifications.

B. Corrosion Resistant Chimney Sealant

1. **Typical Applications:** A brush applied, corrosion resistant, aromatic urethane sealant is utilized for sealing existing manhole chimneys, which are showing signs of infiltration or deterioration due to sulfuric acid attack.
2. **Description of Process and Materials:** The existing surface is prepared by removing all protruding brick, mortar, and other debris. The manhole chimney is sandblasted and pressure washed. Active leaks in the chimney area are sealed with hydraulic cement prior to application of the sealant. The area is then primed, the sealant is mixed, and applied with a brush or trowel. The sealant forms a flexible membrane over the chimney area, which seals out infiltration and protects the area from further chemical attack.

C. Centrifugally Cast Mortar

1. **Typical Applications:** Centrifugally cast mortar linings are utilized to rehabilitate and extend the life of existing manholes, which are still structurally sound, but are experiencing groundwater infiltration and/or moderate deterioration due to the presence of sulfuric acid. This rehabilitation method is used for lining both brick and mortar and concrete manholes.
2. **Description of Process and Materials:** The lining process begins by first cleaning the existing manhole walls of any loose material or debris. This is normally accomplished by washing the interior surface of the manhole with a high pressure washer. Any actively leaking joints or cracks are plugged with hydraulic cement. Next, a rotating applicator is lowered into the manhole. As mortar is pumped through the applicator, it spins with sufficient speed to cast the mortar against the manhole wall. The mortar is of sufficient stiffness that it sticks to the wall without sloughing. As the rotating applicator is raised through the manhole, the entire interior surface of the manhole is coated. Multiple passes of the applicator are made until the desired liner thickness is achieved. The centrifugal casting process creates a slightly rough "orange peel" surface. Normally, the mortar should be smoothed with a brush or trowel to ensure a solid bond to the existing manhole and to create a more finished appearance.

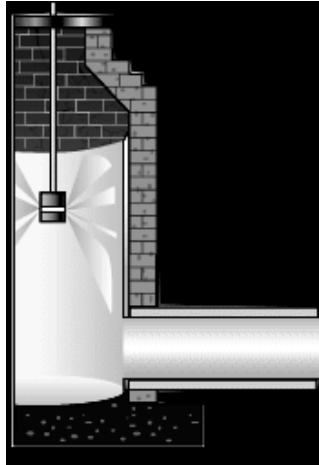
Figure 14C-3.01: Centrifugally Cast Mortar Application

Source: AP/M Permaform

After the liner has been applied to the walls of the manhole, the bench and invert are rehabilitated with the application of 3 inches of hand applied mortar.

If the manhole is being rehabilitated due to deterioration caused by attack by sulfuric acid, an epoxy lining should be applied to protect the new liner from future attack. Typically, this epoxy lining is applied using a rotating centrifugal applicator or an airless sprayer to prevent air entrainment.

The mortar used for the lining process is a high strength, high build corrosion resistant mortar with a 28 day compressive strength of 10,000 psi (24 hours = 3,000 psi). The epoxy coating consists of a two-component, 100% solid epoxy formulated for use in sewer systems.

3. **Design of Liner Thickness:** It should be emphasized that centrifugally cast liners are not intended to be structural in nature. They are only to be applied to existing manholes, which are structurally sound but beginning to deteriorate due to infiltration and/or chemical attack. The liners act to stop any further deterioration of the existing manhole.

The design of the liner thickness is highly dependent on several factors, including the depth of the water table, traffic loads, and time of opening to traffic. Traffic should be kept off of the area surrounding the manhole for a minimum of 12 hours. The longer the liner has to cure and gain strength prior to applying traffic loads, the thinner the liner may be as indicated in the table below.

Table 14C-3.01: Liner Thicknesses
(Based upon a 48 inch diameter manhole)

Time to opening to Traffic	Manhole Depth (feet)	Minimum Liner Thickness (inches)
12 hrs (min)	0 to 30	1.25
24 hrs	0 to 30	1.00
7 days	0 to 15	0.75
7 days	15 to 30	1.00

Source: J. Pitt, 1995

D. In-situ Manhole Replacement

1. **Typical Applications:** In-situ manhole replacement is utilized to rehabilitate existing manholes that are severely deteriorated due to infiltration or chemical attack and are no longer structurally sound.

Since the process results in a new structure inside the manhole, it may even be utilized on structures that are completely missing portions of the walls or bench. Forms are available for both round and rectangular manholes and can be custom fabricated for other odd shaped structures.

2. **Description of Process and Materials:** In-situ manhole replacement consists of constructing forms inside an existing manhole and pouring new walls, which are structurally independent of the existing walls.

In-situ manhole replacement begins by removing any loose material or debris. If steps are present, they are cut off at the wall. Pipe extensions through the structure are placed to maintain flow during construction. If significant infiltration is present, it should be controlled by plugging holes with hydraulic cement. After the manhole has been prepared, steel forms are erected inside of the manhole, creating a 3 inch gap between the existing manhole wall and the new form.

If previous manhole deterioration was the result of chemical attack, a plastic liner may be placed around the exterior of the forms. This plastic liner will eventually form the inside surface of the new wall. The liner has ribs on the back side to anchor it into the concrete.

After the forms have been erected and the plastic liner secured, if applicable, the annular space between the forms and the existing wall are filled with 4,000 psi concrete. When the concrete has cured sufficiently, the forms are disassembled and removed. If a plastic liner is utilized, any joints in the material are fusion welded to create an airtight seal.

The bench of the manhole is then overlaid by hand with 10,000 psi concrete and epoxy coated. Sand is spread over the wet epoxy coating to create a non-slip surface. The final step is to remove any pipe extension through the manhole and properly seal around any manhole penetrations.

Figure 14C-3.02: In-situ Manhole Replacement (AP/M Permaform)

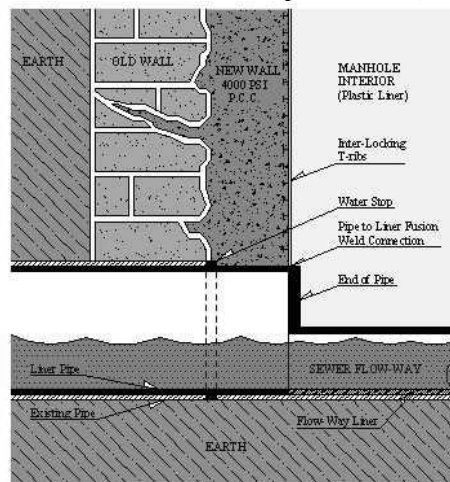

Source: AP/M Permaform



References

ASTM F 1216. *Standard Practice for Rehabilitation of Existing Pipelines and Conduits by the Inversion and Curing of a Resin-Impregnated Tube*. ASTM International.

ASTM F 1504. *Standard Specification for Folded Poly (Vinyl Chloride) (PVC) Pipe for Existing Sewer and Conduit Rehabilitation*. ASTM International.

ASTM F 1947. *Standard Practice for Installation of Folded Poly (Vinyl Chloride) (PVC) Pipe into Existing Sewers and Conduits*. ASTM International.

ASTM F 1871. *Standard Specification for Folder/Formed Poly (Vinyl Chloride) Pipe Type A for Existing Sewer and Conduit Rehabilitation*. ASTM International.

ASTM F 1867. *Standard Practice for Installation of Folded/Formed Poly (Vinyl Chloride) (PVC) Pipe Type A for Existing Sewer and Conduit Rehabilitation*. ASTM International.

ASTM F 1533. *Standard Specification for Deformed Polyethylene (PE) Liner*. ASTM International.

ASTM F 1606. *Standard Practice for Rehabilitation of Existing Sewers and Conduits with Deformed Polyethylene (PE) Liner*. ASTM International.

American Concrete Pipe Association. *Concrete Pipe Design Manual*. Irving, Texas. 2002.

Dipenbrock, E., et al. *Risk Allocation in Construction Projects*. Lorman Education Services. 2002.

Inliner Technologies, LLC. *Engineering Design Guide*.

Iseley, T. and Gokhale, S. *Trenchless installation of conduits beneath roadways*. NCHRP Synthesis 242. Transportation Research Board/National Research Council. Washington, D.C. 1997.

Iseley, T. and Najafi, M. *Trenchless Pipeline Rehabilitation*. Prepared for the National Utility Contractors Association. Arlington, VA. 1995.

Iseley, Najafi, and Tanwani. *Trenchless Construction Methods and Soil Compatibility Manual*. National Utility Contractors Association. Arlington, VA. 1999.

Nella Drilling Inc. Other Techniques. Available at: <http://www.nella-drilling.com/en/> Accessed July 2017.

North American Society for Trenchless Technology. Glossary. Available at: <http://www.nastt.org/> Accessed October 2012.

AP/M Permaform. No Dig Renewal. Available at: <http://www.permaform.net/> Accessed November 2016.

The Pipe Jacking Association. About the Technique. Available at: <http://www.pipejacking.org/> Accessed October 2012.

Pitt, J. *Centrifugal Cast Mortar for In Situ Manhole Rehabilitation*. Iowa State University. Ames, IA. Presented to the North American Society for Trenchless Technology. 1995.

PROFUNDIS Presse. Techniques. Available at: <http://www.nodig-construction.com/> Accessed October 2012.

Simicevic, J. and Sterling R. *Guidelines for Impact Moling*. TTC Technical Report #2001.03. U.S. Army Corps of Engineers, Vicksburg, MS. 2001.

Sterling, R and Thorne, J. *Trenchless Technology Applications in Public Works*. American Public Works Association, Kansas City, MO. 1999.

Suleiman, M, L. Stevens, C. Jhren, H. Ceylan, and W. Conway. *Identification of Practices, Design, Construction, and Repair Using Trenchless Technology*. 2010.