



Table of Contents

Chapter 6 - Geotechnical

6A General Information

- 6A-1-----General Information
 - A. Introduction.....1
 - B. Definitions.....1

- 6A-2-----Basic Soils Information
 - A. General Information.....1
 - B. Soil Types.....1
 - C. Classification.....2
 - D. Moisture-Density Relationships for Soils.....5
 - E. References.....9

- 6A-3-----Typical Iowa Soils
 - A. General Information.....1
 - B. Iowa Geology.....1
 - C. References.....4

6B Subsurface Exploration Program

- 6B-1-----Subsurface Exploration Program
 - A. General Information.....1
 - B. Program Phases.....1
 - C. Site Characterization.....2
 - D. Sampling.....4

- 6B-2-----Testing
 - A. General Information.....1
 - B. Field Testing.....1
 - C. Laboratory Testing.....4

- 6B-3-----Geotechnical Report
 - A. Geotechnical Report.....1
 - B. References.....2

6C Pavement Systems

- 6C-1-----Pavement Systems
 - A. General Information.....1
 - B. Pavement Support.....1
 - C. Pavement Problems.....2

6D Embankment Construction

6D-1-----Embankment Construction	
A. General Information.....	1
B. Site Preparation.....	3
C. Design Considerations.....	3
D. Equipment.....	5
E. Density.....	6
F. Compaction.....	7
G. Embankment Soils.....	9
H. Testing.....	11
I. References.....	13

6E Subgrade Design and Construction

6E-1-----Subgrade Design and Construction	
A. General Information.....	1
B. Site Preparation	1
C. Design Considerations.....	1
D. Strength and Stiffness.....	3
E. Subgrade Construction.....	7
F. References.....	10

6F Pavement Subbase Design and Construction

6F-1-----Pavement Subbase Design and Construction	
A. General Information.....	1
B. Granular Subbases	1
C. Recycled Materials.....	2
D. Effects of Stability and Permeability on Pavement Foundation.....	3
E. Effect of Compaction.....	4
F. Influence of Aggregate Properties on Permeability of Pavement Bases.....	5
G. Construction Methods.....	5
H. Quality Control/Quality Assurance Testing.....	6
I. References.....	7

6G Subsurface Drainage Systems

6G-1-----Subsurface Drainage Systems	
A. General Information.....	1
B. Need for Subsurface Drainage.....	3
C. Types of Drainage Systems.....	4
D. Design.....	6
E. Construction Issues.....	8
F. Maintenance.....	9
G. References.....	10

6H Foundation Improvement and Stabilization

6H-1-----	Foundation Improvement and Stabilization	
A.	General Information.....	1
B.	Stabilization.....	1
C.	Subsurface Drainage.....	5
D.	Geosynthetics.....	6
E.	Soil Encapsulation.....	9
F.	Moisture Conditioning.....	9
G.	Granular Subbases.....	10
H.	References.....	10

General Information

A. Introduction

The performance of pavements depends upon the quality of subgrades and subbases. A stable subgrade and properly draining subbase help produce a long-lasting pavement. A high level of spatial uniformity of a subgrade and subbase in terms of key engineering parameters such as shear strength, stiffness, volumetric stability, and permeability is vital for the effective performance of the pavement system. A number of environmental variables such as temperature and moisture affect these geotechnical characteristics, both in short and long term. The subgrade and subbase work as the foundation for the upper layers of the pavement system and are vital in resisting the detrimental effects of climate, as well as static and dynamic stresses that are generated by traffic. Furthermore, there has been a significant amount of research on stabilization/treatment techniques, including the use of recycled materials, geotextiles, and polymer grids for the design and construction of uniform and stable subgrades and subbases.

However, the interplay of geotechnical parameters and stabilization/treatment techniques is complex. This has resulted in a gap between the state-of-the-art understanding of geotechnical properties of subgrades and subbases based on research findings, and the design and construction practices for these elements. The purpose of this manual is to synthesize findings from previous and current research in Iowa and other states into a practical geotechnical design guide for subgrades and subbases. This design guide will help improve the design, construction, and testing of pavement foundations, which will in turn extend pavement life.

The primary consideration for this chapter is that new and reconstruction projects of pavement require characterization of the foundation soils and a geotechnical design. This chapter presents definitions of the terminology used and summarizes basic soil information needed by designers for different project types for pavement design and construction, including embankment construction, subgrade and subbase design and construction, subsurface drainage, and subgrade stabilization.

B. Definitions

Atterberg Limits:

- **Liquid Limit (LL):** The moisture content at which any increase in the moisture content will cause a plastic soil to behave as a liquid. The limit is defined as the moisture content, in percent, required to close a distance of 0.5 inches along the bottom of a groove after 25 blows in a liquid limit device.
- **Plastic Limit (PL):** The moisture content at which any increase in the moisture content will cause a semi-solid soil to become plastic. The limit is defined as the moisture content at which a thread of soil just crumbles when it is carefully rolled out to a diameter of 1/8 inch.
- **Plasticity Index (PI):** The difference between the liquid limit and the plastic limit. Soils with a high PI tend to be predominantly clay, while those with a lower PI tend to be predominantly silt.

Flexible Pavement: Hot Mix Asphalt (HMA) pavement, also commonly called asphalt pavement.

Pavement System: Consists of the pavement and foundation materials (see Figure 6A-1.01).

Foundation Materials: Material that supports the pavement, which are layers of subbase and subgrade.

Pavement: The pavement structure, the upper surface of a pavement system, or the materials of which the pavement is constructed, including all lanes and the curb and gutter. Consist of flexible or rigid pavements, typically Hot Mix Asphalt (HMA) or PCC, respectively, or a composite of the two.

Figure 6A-1.01: Typical Section

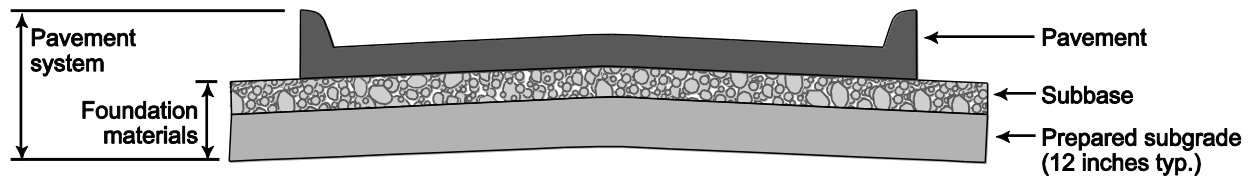

Rigid Pavement: PCC pavement, also commonly called concrete pavement.

Subbase: The layer or layers of specified or selected material of designed thickness, placed on a subgrade to support a pavement. Also called granular subbase.

Subgrade: Consists of the naturally occurring material on which the road is built, or the imported fill material used to create an embankment on which the road pavement is constructed. Subgrades are also considered layers in the pavement design, with their thickness assumed to be infinite and their material characteristics assumed to be unchanged or unmodified. Prepared subgrade is typically the top 12 inches of subgrade.

Basic Soils Information

A. General Information

This section summarizes the basic soil properties and definitions required for designing pavement foundations and embankment construction. Basic soil classification and moisture-density relationships for compacted cohesive and cohesionless soil materials are included. The standard for soil density is determined as follows:

1. **Coarse-grained Soil:** The required minimum relative density and moisture range should be specified if it is a bulking soil.
2. **Fine-grained Soil:** The required minimum dry density should be specified; then the acceptable range of moisture content should be determined through which this density can be achieved.
3. **Inter-grade Soils:** The required minimum dry density or relative density should be specified, depending on the controlling test. Moisture range is determined by the controlling test.

B. Soil Types

1. **Soil:** Soils are sediments or other unconsolidated accumulation of solid particles produced by the physical and chemical disintegration of rocks, and which may or may not contain organic matter. Soil has distinct advantages as a construction material, including its relative availability, low cost, simple construction techniques, and material properties which can be modified by mixing, blending, and compaction. However, there are distinct disadvantages to the use of soil as a construction material, including its non-homogeneity, variation in properties in space and time, changes in stress-strain response with loading, erodability, weathering, and difficulties in transitions between soil and rock.

Prior to construction, engineers conduct site characterization, laboratory testing, and geotechnical analysis, design and engineering. During construction, engineers ensure that site conditions are as determined in the site characterization, provide quality control and quality assurance testing, and compare actual performance with predicted performance.

Numerous soil classification systems have been developed, including geological classification based on parent material or transportation mechanism, agricultural classification based on particle size and fertility, and engineering classification based on particle size and engineering behavior. The purpose of engineering soil classification is to group soils with similar properties and to provide a common language by which to express general characteristics of soils.

Engineering soil classification can be done based on soil particle size and by soil plasticity. Particle size is straightforward. Soil plasticity refers to the manner in which water interacts with the soil particles. Soils are generally classified into four groups using the Unified Soil Classification System, depending on the size of the majority of the soil particles (ASTM D 3282, AASHTO M 145).

- a. **Gravel:** Fraction passing the 3 inch sieve and retained on the No. 10 sieve.

- b. **Sand:** Fraction passing No. 10 sieve and retained on the No. 200 sieve.
 - c. **Silt and Clay:** Fraction passing the No. 200 sieve. To further distinguish between silt and clay, hydrometer analysis is required. Manually, clay feels slippery and sticky when moist, while silt feels slippery but not sticky.
 - 1) **Fat Clays:** Cohesive and compressible clay of high plasticity, containing a high proportion of minerals that make it greasy to the feel. It is difficult to work when damp, but strong when dry.
 - 2) **Lean Clays:** Clay of low-to-medium plasticity owing to a relatively high content of silt or sand.
2. **Rock:** Rocks are natural solid matter occurring in large masses or fragments.
 3. **Iowa Soils:** The three major soils distributed across Iowa are loess, glacial till, and alluvium, which constitute more than 85% of the surface soil.
 - a. **Loess:** A fine-grained, unstratified accumulation of clay and silt deposited by wind.
 - b. **Glacial Till:** Unstratified soil deposited by a glacier; consists of sand, clay, gravel, and boulders.
 - c. **Alluvium:** Clay, silt, or gravel carried by running streams and deposited where streams slow down.

C. Classification

Soils are classified to provide a common language and a general guide to their engineering behavior, using either the Unified Soil Classification System (USCS) (ASTM D 3282) or the AASHTO Classification System (AASHTO M 145). Use of either system depends on the size of the majority of the soil particles to classify the soil.

1. **USCS:** In the USCS (see Table 6A-2.01), each soil can be classified as:
 - Gravel (G)
 - Sand (S)
 - Silt (M)
 - Clay (C)
2. **AASHTO:** In the AASHTO system (see Table 6A-2.02), the soil is classified into seven major groups: A-1 through A-7. To classify the soil, laboratory tests including sieve analysis, hydrometer analysis, and Atterberg limits are required. After performing these tests, the particle size distribution curve (particle size vs. percent passing) is generated, and the following procedure can be used to classify the soil.

A comparison of the two systems is shown in Table 6A-2.03.

Table 6A-2.01: Unified Soil Classification System Soil Classification Chart

MAJOR DIVISIONS		GROUP SYMBOLS	TYPICAL NAMES	FIELD IDENTIFICATION PROCEDURES		CLASSIFICATION CRITERIA	
COARSE-GRAINED SOILS More than 50% retained on No. 200 sieve*	GRAVELS 50% or more of coarse fraction retained on No. 4 sieve	GW	Well-graded gravels and gravel-sand mixtures, little or no fines	Wide range in grain sizes and substantial amounts of all intermediate particle sizes	CLASSIFICATION ON BASIS OF PERCENTAGE OF FINES Less than 5% pass No. 200 sieve=GW, GP, SW, SP.	$C_u = D_{60}/D_{10}$ Greater than 4 $C_c = \frac{(D_{30})^2}{D_{10} \times D_{60}}$ Between 1 and 3	
		GP	Poorly graded gravels and gravel-sand mixtures, little or no fines	Predominantly one size or a range of sizes with some intermediate sizes missing			
	SANDS More than 50% of coarse fraction passes No. 4 sieve	GH	Silty gravels, gravel-sand-clay mixtures	Nonplastic fines or fines with low plasticity (for identification procedures, see ML below)	CLASSIFICATION ON BASIS OF PERCENTAGE OF FINES 5% to 12% pass No. 200 sieve-borderline classification, requiring the use of dual symbols.	Afterberg limits plot below "A" line or plasticity index less than 4 Afterberg limits plot above "A" line and plasticity index greater than 7	$C_u = D_{60}/D_{10}$ Greater than 6 $C_c = \frac{(D_{30})^2}{D_{10} \times D_{60}}$ Between 1 and 3
		GC	Clayey gravels, gravel-sand-clay mixtures	Plastic fines (for identification procedures, see CL below)			
FINE-GRAINED SOILS 50% or more passes No. 200 sieve*	CLEAN SANDS	SW	Well-graded sands and gravelly sands, little or no fines	Wide range in grain size and substantial amounts of all intermediate particle sizes	CLASSIFICATION ON BASIS OF PERCENTAGE OF FINES More than 12% pass No. 200 sieve=GM, GC, SM, SC.	Not meeting both criteria for SW Afterberg limits plot below "A" line or plasticity index less than 4 Afterberg limits plot above "A" line and plasticity index greater than 7	
		SP	Poorly graded sands and gravelly sands, little or no fines	Predominantly one size or a range of sizes with some intermediate sizes missing			
	SANDS WITH FINES	SM	Silty sands, sand-silt mixtures	Nonplastic fines or fines with low plasticity (for identification procedures, see ML below)	CLASSIFICATION ON BASIS OF PERCENTAGE OF FINES More than 12% pass No. 200 sieve=GM, GC, SM, SC.	Not meeting both criteria for SW Afterberg limits plot below "A" line or plasticity index less than 4 Afterberg limits plot above "A" line and plasticity index greater than 7	
		SC	Clayey sands, sand-clay mixtures	Plastic fines (for identification procedures, see CL below)			
	SILTS AND CLAYS Liquid limit 50% or less	SILTS AND CLAYS Liquid limit greater than 50%	ML	Inorganic silts, very fine sands, rock flour, silty or clayey fine sands	Dry Strength (Crushing characteristics) None to slight None to high Slight to medium Slight to medium High to very high	CLASSIFICATION ON BASIS OF PERCENTAGE OF FINES More than 12% pass No. 200 sieve=GM, GC, SM, SC.	Not meeting both criteria for SW Afterberg limits plot below "A" line or plasticity index less than 4 Afterberg limits plot above "A" line and plasticity index greater than 7
			CL	Inorganic clays of low to medium plasticity, gravelly clays, sandy clays, silty clays, lean clays	Quick to slow None to very slow Medium Slight		
			OL	Organic silts and organic silty clays of low plasticity	Slow Slow to none None		
			MH	Inorganic silts, micaceous or diatomaceous fine sands or silts, elastic silts	Slow to none None		
CH			Inorganic clays of high plasticity, fat clays	Slow to medium Slight to medium High			
Highly Organic Soils	Highly Organic Soils	OH	Organic clays of medium to high plasticity	None to very slow Medium to high	CLASSIFICATION ON BASIS OF PERCENTAGE OF FINES More than 12% pass No. 200 sieve=GM, GC, SM, SC.	Not meeting both criteria for SW Afterberg limits plot below "A" line or plasticity index less than 4 Afterberg limits plot above "A" line and plasticity index greater than 7	
		PT	Peat, muck, and other highly organic soils	None to very slow Slight to medium			

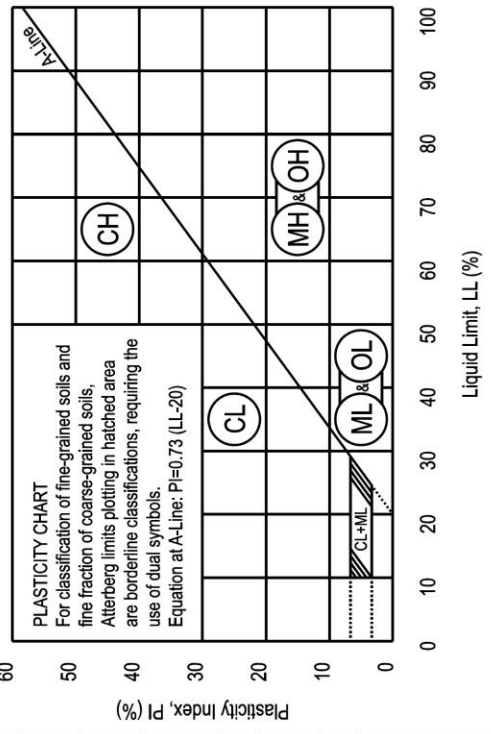

*Based on the material passing the 3 inch sieve

Table 6A-2.02: AASHTO Soil Classification Chart

General Classification	Granular Materials (35% or Less Passing No. 200)						Silt-Clay Materials (More Than 35% Passing No. 200)				
	A-1		A-3	A-2		A-2-7	A-4	A-5	A-6	A-7	
Group Classification	A-1-a	A-1-b	A-3	A-2-4	A-2-5	A-2-6	A-2-7	A-4	A-5	A-6	A-7-5, A-7-6
Sieve analysis, percent passing:	50 max	--	--	--	--	--	--	--	--	--	--
No. 10	30 max	50 max	51 max	--	--	--	--	--	--	--	--
No. 40	15 max	25 max	10 max	35 max	35 max	35 max	35 max	36 min	36 min	36 min	36 min
No. 200											
Characteristics of fraction passing No. 40											
Liquid limit				40 max	41 min	40 max	41 min	40 max	41 min	40 max	41 min
Plasticity limit				10 max	10 max	11 min	11 min	10 max	10 max	11 min	11 min
Usual types of significant constituent materials	Stone fragments, gravel and sand		Fine sand	Silty or clayey gravel and sand			Silty soils		Clayey soils		
General rating as subgrade	Excellent to good						Fair to poor				

Source: AASHTO M 145-2

Table 6A-2.03: Comparison of the AASHTO system with the Unified Soil Classification System

Soil groups in AASHTO system	Comparable soil groups in USCS		
	Most probable	Possible	Possible but improbable
A-1-a	GW, GP	SW, SP	GM, SM
A-1-b	SW, SP, GM, SM	GP	-----
A-3	SP	-----	SW, GP
A-2-4	GM, SM	GC, SC	GW, GP, SW, SP
A-2-5	GM, SM	-----	GW, GP, SW, SP
A-2-6	GC, SM	GM, SM	GW, GP, SW, SP
A-2-7	GM, GC, SM, SC	-----	GW, GP, SW, SP
A-4	ML, OL	CL, SM, SC	GM, GC
A-5	OH, MH, ML, OL	-----	SM, GM
A-6	CL	ML, OL, SC	GC, CM, CM
A-7-5	OH, MH	ML, OL, CH	GM, CM, GC, SC
A-7-6	CH, CL	ML, OL, SC	OH, MH, GC, GC, SM

Source: Liu, 1967

D. Moisture-Density Relationships for Soils

Compaction is the densification of soils by mechanical manipulation. Soil densification entails expelling air out of the soil, which improves the strength characteristics of soils, reduces compressibility, and reduces permeability. Using a given energy, the density of soil varies as a function of moisture content. This relationship is known as the moisture-density curve, or the compaction curve. The energy inputs to the soil have been standardized and are generally defined by Standard Proctor (ASTM D 698 and AASHTO T 99) and Modified Proctor (ASTM D 1557 and AASHTO T 180) tests. These tests are applicable for cohesive soils. For cohesionless soils, the relative density test should be used (ASTM D 4253 and ASTM D 4254). The information below describes the compaction results of both cohesive and cohesionless soils.

- 1. Fine-grained (Cohesive) Soils:** The moisture-density relationship for fine-grained (cohesive) soils (silts and clays) is determined using Standard or Modified Proctor tests. Typical results of Standard Proctor tests are shown in Figure 6A-2.02, which represents the relationship between the moisture content and the dry density of the soil. At the peak point of the curve, moisture content is called the optimum moisture content, and the density is called the maximum dry density. If the moisture content exceeds the optimum moisture content, the soil is called wet of optimum. On the other hand, if the soil is drier than optimum, the soil is called dry of optimum.

The compaction energy used in Modified Proctor is 4.5 times the compaction energy used in Standard Proctor. This increase in compaction energy changes the point-of-optimum moisture content and maximum dry density (see Figure 6A-2.02). In the field, the compaction energy is generally specified as a percentage of the Standard Proctor or Modified Proctor by multiplying the maximum dry density by this specified percent. Figure 6A-2.03 shows Proctor test results with a line corresponding to the specified percentage of the maximum dry density. The area between the curve and the specified percentage line would be the area of acceptable moisture and density.

Soils compacted on the dry side of optimum have higher strength, stability and less compressibility than the same soil compacted on the wet side of optimum. However, soils compacted on the wet side of optimum have less permeability and volume change due to change in moisture content. The question of whether to compact the soil on the dry side of optimum or on the wet side of optimum depends on the purpose of the construction and construction equipment. For example, when constructing an embankment, strength and stability are the main concern (not permeability); therefore, a moisture content on the dry side of optimum should be used. For contractors, compacting the soil on the wet side of optimum is more economical, especially if it is within 2% of the optimum moisture content. However, if the soil is too wet, the specified compaction density will not be reached.

Figure 6A-2.02: An Example of Standard and Modified Proctor Moisture-Density Curves for the Same Soil

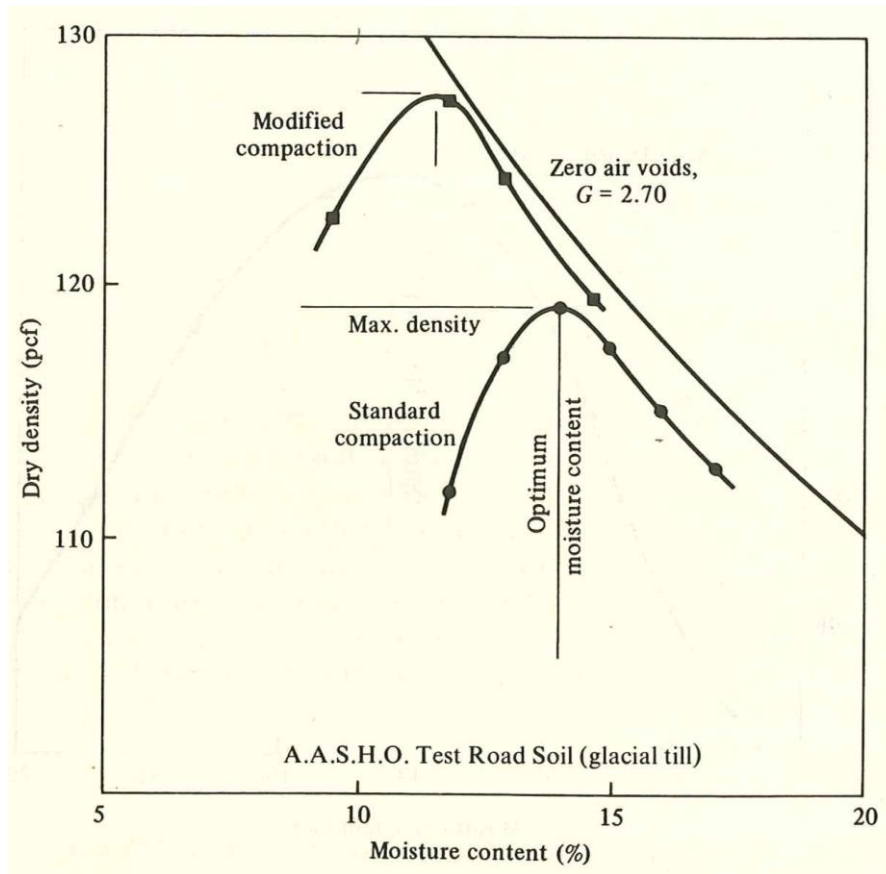

Source: Spangler and Handy 1982

Figure 6A-2.03: Example Proctor Test Results with Specified Percentage Compaction Line

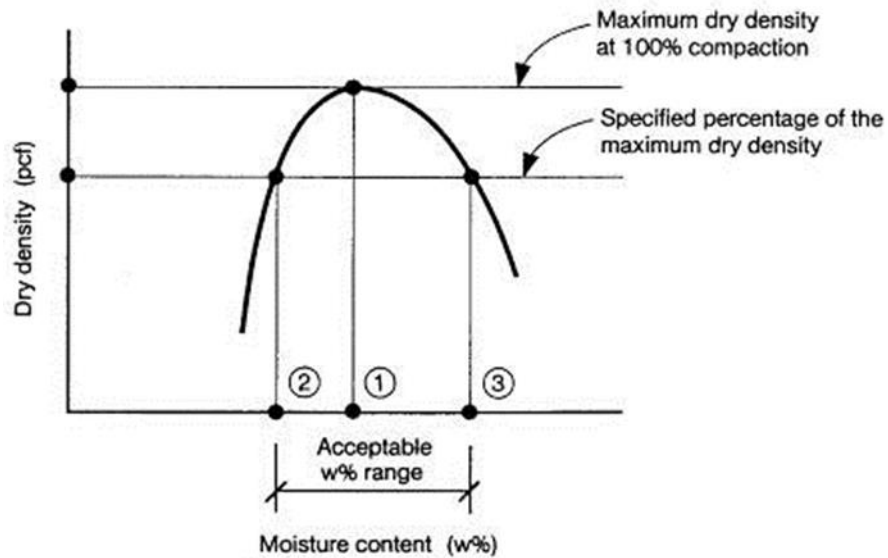

Source: Duncan 1992

- 2. Coarse-grained (Cohesionless) Soils:** When coarse-grained, cohesionless soils (sands and gravels) are compacted using standard or modified Proctor procedures, the moisture-density curve is not as distinct as that shown for cohesive soils in Figure 6A-2.02. Figure 6A-2.04 shows a typical curve for cohesionless materials, exhibiting what is often referred to as a hump back or camel back shape. It can be seen that the granular material achieves its densest state at 0% moisture, then decreases to a relative low value, and then increases to a relative maximum, before decreasing again with increasing water content. A better way of representing the density of cohesionless soils is through relative density. Tests can be conducted to determine the maximum density of the soil at its densest state and the minimum density at its loosest state (ASTM D 4253 and D 4254). The relative density of a field soil, D_r , can be defined using the density measured in the field, through a ratio to the maximum and the minimum density of the soil, using Equation 6A-2.01.

$$D_r (\%) = \left[\frac{\gamma_{d(\text{field})} - \gamma_{d(\text{min})}}{\gamma_{d(\text{max})} - \gamma_{d(\text{min})}} \right] \left[\frac{\gamma_{d(\text{max})}}{\gamma_{d(\text{field})}} \right] \quad \text{Equation 6A-2.01}$$

where:

$\gamma_{d(\text{field})}$ = field density

$\gamma_{d(\text{min})}$ = minimum density

$\gamma_{d(\text{max})}$ = maximum density

The maximum and minimum density testing is performed on oven-dry cohesionless soil samples. However, soils in the field are rarely this dry, and cohesionless soils are known to experience bulking as a result of capillary tension between soil particles. Bulking is a capillary phenomena occurring in moist sands (typically 3 to 5% moisture) in which capillary menisci between soil particles hold the soil particles together in a honeycomb structure. This structure can prevent adequate compaction of the soil particles and is also susceptible to collapse upon the addition of water (see Figure 6A-2.05). The bulking moisture content should be avoided in the field.

Figure 6A-2.04: Example of Relative Density vs. Standard Proctor Compaction

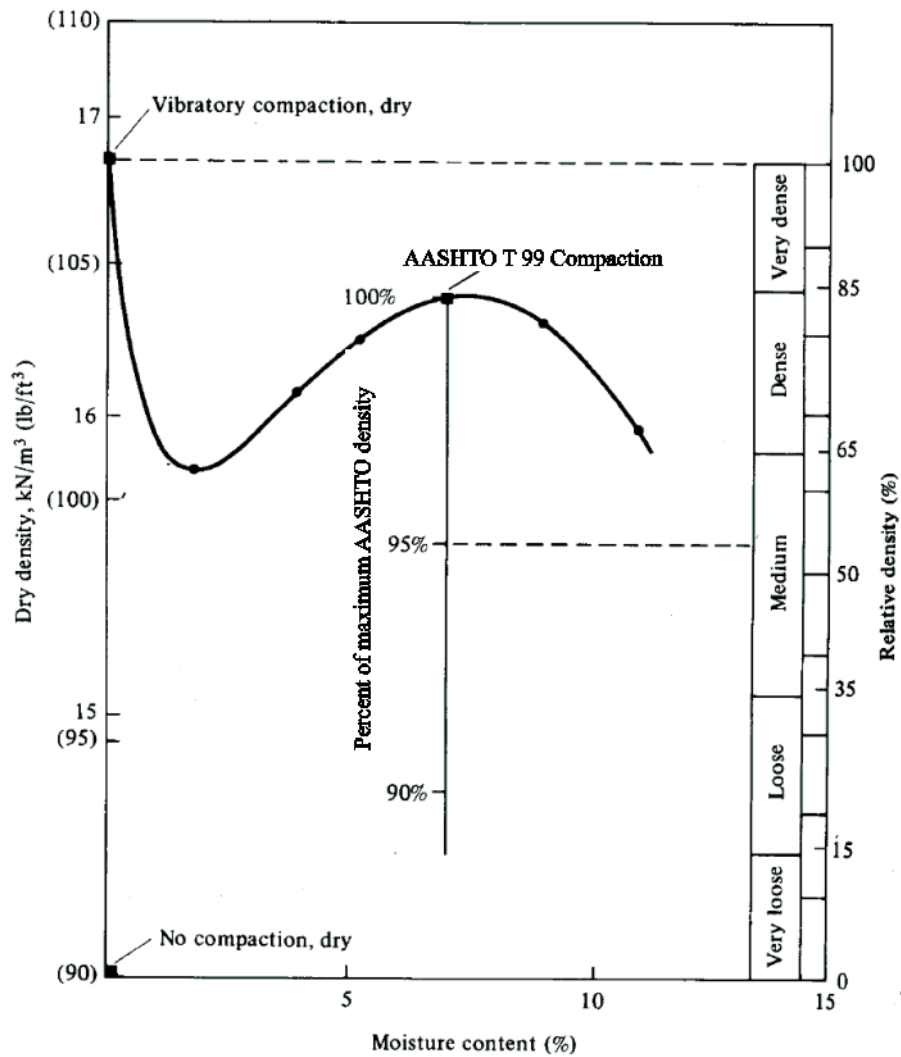

Source: Spangler and Handy 1982

Figure 6A-2.05: Example Showing the Processes of Collapse due to Bulking Moisture

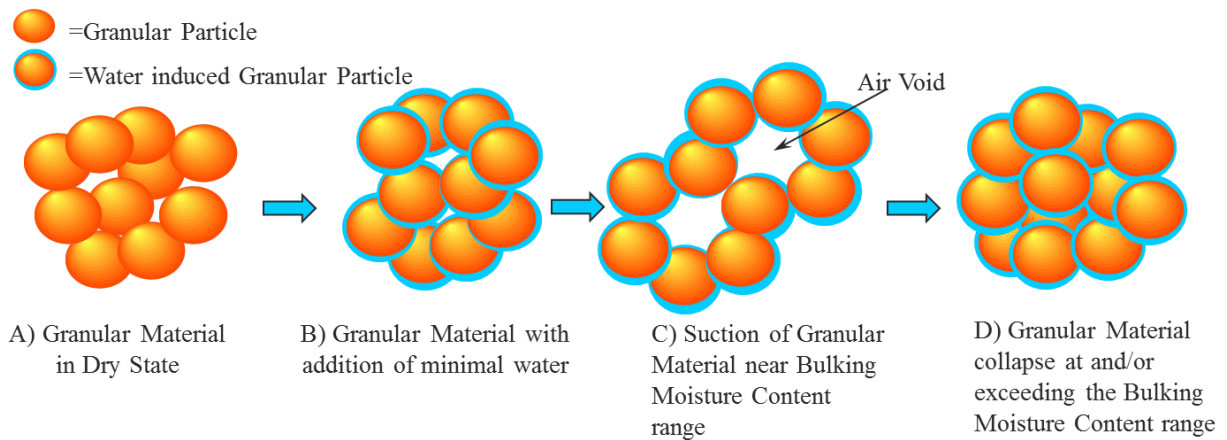

Source: Schaefer et al. 2005

E. References

Das, B.M. *Principles of Geotechnical Engineering*. Pacific Grove: Brooks Cole. 2002.

Duncan, C.I. *Soils and Foundations for Architects and Engineers*. New York: Van Nostrand Reinhold. 1992.

Schaefer, V.R., M.T. Suleiman, D.J. White, and C. Swan. *Utility Cut Repair Techniques - Investigation of Improved Utility Cut Repair Techniques to Reduce Settlement in Repaired Areas*. Iowa: Report No. TR-503, Iowa Department of Transportation. 2005.

Spangler, M.G., and R. Handy. *Soil Engineering*. New York: Harper & Row. 1982.

Typical Iowa Soils

A. General Information

There are three major types of soils in Iowa:

1. **Loess:** A fine-grained, unstratified accumulation of clay and silt deposited by wind (37.5%).
2. **Glacial Till:** Unstratified soil deposited by a glacier; consists of clay, silt, sand, gravel, and boulders (28.5%).
3. **Alluvium:** Clay, silt, sand, or gravel carried by running streams and deposited where streams slow down (20.1%).

Other types of soils, occurring in smaller amounts in Iowa, are:

- Sand and gravel (4.5%)
- Paleosols (4.0%)
- Bedrock (2.7%)
- Fine sand (1.4%)

B. Iowa Geology

The Iowa landscape consists mainly of seven topographic regions (see Figure 6A-3.01).

- Des Moines Lobe
- Loess Hills
- Southern Iowa Drift Plain
- Iowan Surface
- Northwest Iowa Plains
- Paleozoic Plateau
- Alluvial Plains

The soils in the Des Moines Lobe, Southern Iowa Drift Plain, Iowan Surface, Northwest Iowa Plains, and Paleozoic Plateau originated from glacial action at different periods in geologic time. The northwestern and southern parts of the state consist of glacial till covered by loess. The engineering properties of glacial till change as the age of glacial action changes. Loess soil engineering properties depend mainly on clay content. Figures 6A-3.01, 6A-3.02, and 6A-3.03 show the landform regions, the landform materials and terrain characteristics, and soil permeability.

Figure 6A-3.01: Landform Regions of Iowa

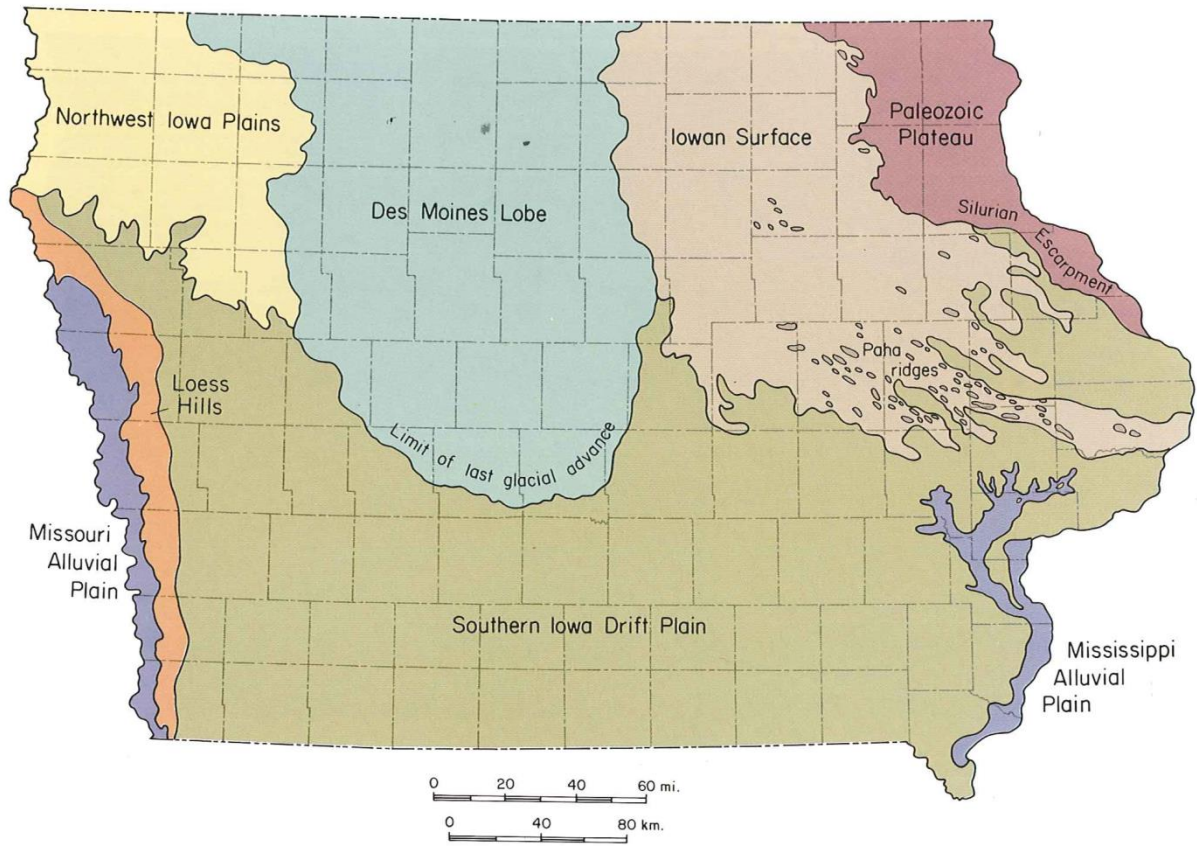

Source: Prior 1991

Figure 6A-3.02: Landform Materials and Terrain Characteristics of Iowa

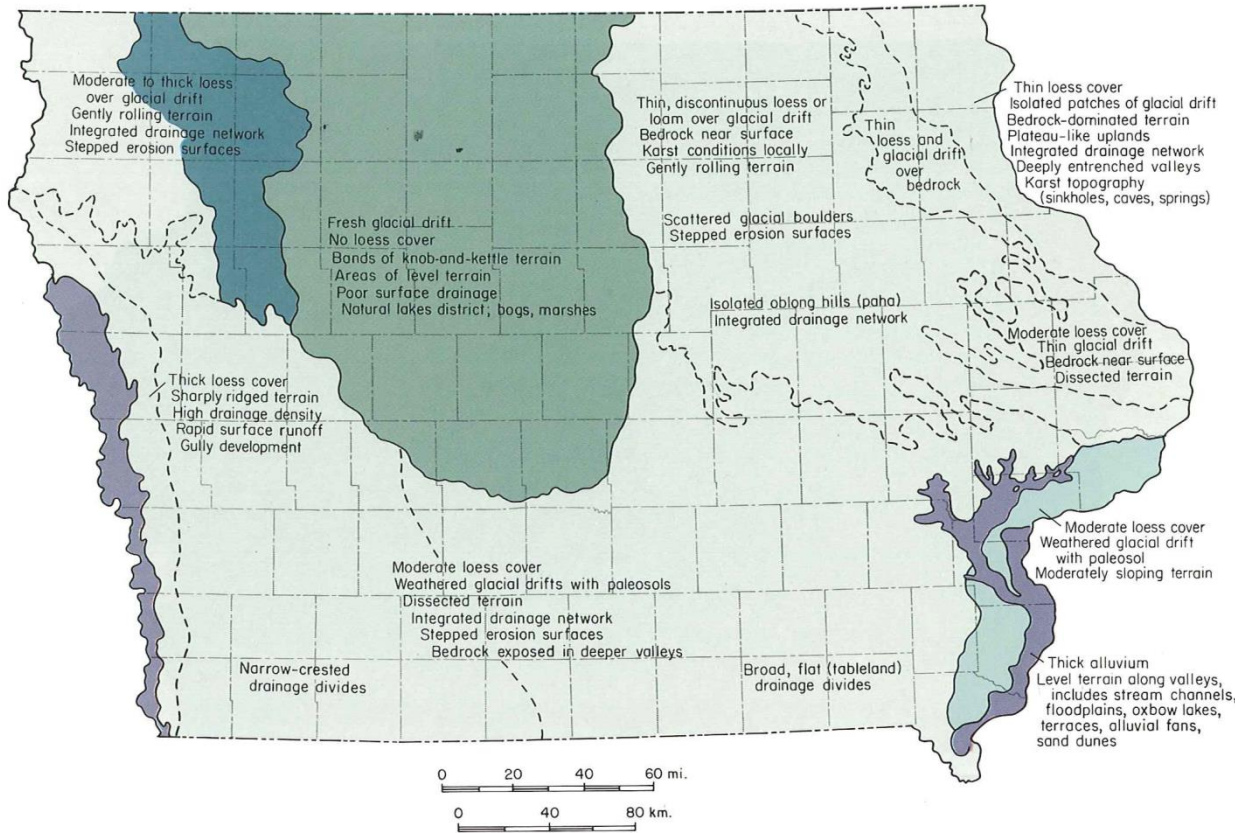

Source: Prior 1991

Figure 6A-3.03: Soil Permeability Rates and Hydrologic Regions in Iowa

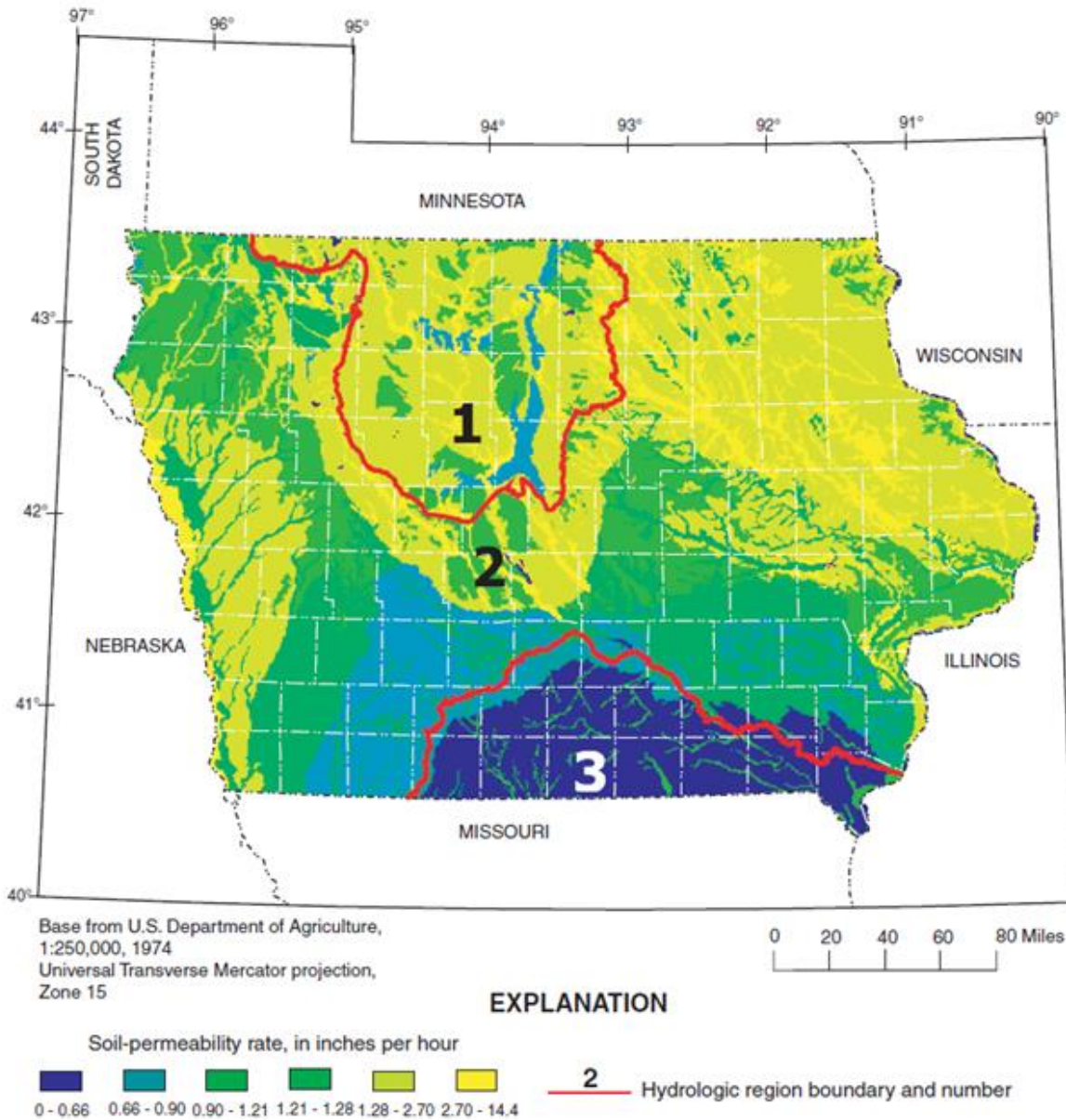

Source: Eash 2001

C. References

Eash, D.A. *Techniques for Estimating Flood-Frequencies Discharges for Streams in Iowa*. Iowa City, Iowa: Iowa Department of Transportation and the Iowa Highway Research Board. 2001.

Prior, J.C. *Landforms of Iowa*. Iowa City, Iowa: Department of Natural Resources, University of Iowa Press. 1991.



Subsurface Exploration Program

A. General Information

A subsurface exploration program is conducted to make designers aware of the site characteristics and properties needed for design and construction. The horizontal and vertical variations in subsurface soil types, moisture contents, densities, and water table depths must be considered during the pavement design process. The purpose of conducting a subsurface exploration is to describe the geometry of the soil, rock, and water beneath the surface; and to determine the relevant engineering characteristics of the earth materials using field tests and/or laboratory tests. More importantly, special subsurface conditions, such as swelling soils and frost-susceptible soils, must be identified and considered in pavement design. The phases of the subsurface exploration program, as well as the in-situ test, are summarized below.

B. Program Phases

The objective of subsurface investigations or field exploration is to obtain sufficient subsurface data to permit selection of the types, locations, and principal dimensions of foundations for all roadways comprising the proposed project. These explorations should identify the site in sufficient detail for the development of feasible and cost-effective pavement designs. Often the site investigation can proceed in phases, including desk study prior to initiating the site investigation. For the desk study, the geotechnical engineer needs to:

1. Review existing subsurface information. Possible sources of information include:
 - a. Previous geotechnical reports
 - b. Prior construction and records of structural performance problems at the site
 - c. U.S. Geological Survey (USGS) maps, reports, publications, and Iowa Geological Survey website
 - d. State geological survey maps, reports, and publications
 - e. Aerial photographs
 - f. State, city, and county road maps
 - g. Local university libraries
 - h. Public libraries
2. Obtain from the design engineer the geometry and elevation of the proposed facility, load and performance criteria, and the locations and dimensions of the cuts and fills.

3. Visit the site with the project design engineer if possible, with a plan in-hand. Review the following:
 - a. General site conditions
 - b. Geologic reconnaissance
 - c. Geomorphology
 - d. Location of underground and aboveground utilities
 - e. Type and condition of existing facilities
 - f. Access restriction for equipment
 - g. Traffic control required during field investigation
 - h. Right-of-way constraints
 - i. Flood levels
 - j. Benchmarks and other reference points
4. Based on the three steps above, plan the subsurface exploration location, frequency and depth. General guidelines are provided below.

C. Site Characterization

1. Frequency and Depth of Borings:

- a. **Roadways:** 200 feet is generally the maximum spacing along the roadway. The location and spacing of borings may need to be changed due to the complexity of the soil/rock conditions.
- b. **Cuts:** At least one boring should be performed for each cut slope. If the length of cuts is more than 200 feet, the spacing between borings should be 200 to 400 feet. At critical locations and high cuts, provide at least three borings in transverse direction to explore the geology conditions for stability analysis. For an active slide, place at least one boring upslope of the sliding area.
- c. **Embankment:** See criteria for cuts.
- d. **Culverts:** At least one boring should be performed at each major culvert. Additional borings may be provided in areas of erratic subsurface conditions.
- e. **Retaining Walls:** At least one boring should be performed at each retaining wall. For retaining walls more than 100 feet in length, the spacing between borings should be no more than 200 feet.
- f. **Bridge Foundations:** For piers or abutments greater than 100 feet wide, at least two borings should be performed. For piers or abutments less than 100 feet wide, at least one boring should be performed. Additional borings may be performed in areas of erratic subsurface conditions.

2. Depth Requirements for Borings:

- a. **Roadways:** Minimum depth should be 6 feet below the proposed subgrade.
- b. **Cuts:** Minimum depth should be 16 feet below the anticipated depth of the cut at the ditch line. The depth should be increased where the location is unstable due to soft soils, or if the base of the cut is below groundwater level.
- c. **Embankments:** Minimum depth should be up to twice the height of the embankment unless hard stratum is encountered above the minimum depth. If soft strata are encountered, which may present instability or settlement concerns, the boring depth should extend to hard material.
- d. **Culverts:** See criteria for embankments.
- e. **Retaining Walls:** Depth should be below the final ground line, between 0.75 and 1.5 times the height of the wall. If the strata indicate unstable conditions, the depth should extend to hard stratum.
- f. **Bridge Foundations:**
 - 1) **Spread Footings:** For isolated footings with a length (L) and width (B):
 - a) If $L \leq 2B$, minimum 2B below the foundation level.
 - b) If $L \geq 5B$, minimum 4B below the foundation level.
 - c) If $2B \leq L < 5B$, minimum can be determined by interpolation between the depths of 2B and 5B below the foundation level.
 - 2) **Deep Foundations:**
 - a) For piles in soil, use the greater depth of 20 feet or a minimum of two times of the pile group dimension below the anticipated elevation.
 - b) For piles on rock, a minimum 10 feet of rock core needs to be obtained at each boring location.
 - c) For shaft supported on rock or into the rock, use the greatest depth of 10 feet, three times the isolated shaft diameter, or two times of the maximum of shaft group dimension.

3. Types of Borings:

- a. **Solid Stem Continuous Flight Augers:** Solid stem continuous flight auger drilling is generally limited to stiff cohesive soils where the boring walls are stable for the whole depth of boring. This type of drilling is not suitable for investigations requiring soil sampling.
- b. **Hollow Stem Continuous Flight Augers:** Hollow stem augering methods are commonly used in clay soils or in granular soils above the groundwater level, where the boring walls may be unstable. These augering methods allow for sampling undisturbed soil below the bit.
- c. **Rotary Wash Borings:** The rotary wash boring method is generally suitable for use below groundwater level. When boring, the sides of the borehole are supported with either casing or the use of drilling fluid.
- d. **Bucket Auger Borings:** Bucket auger drills are used where it is desirable to remove and/or obtain large volumes of disturbed soil samples. This method is appropriate for most types of soils and for soft to firm bedrock. Drilling below the water table can be conducted where materials are firm and not inclined to large-scale sloughing or water infiltration.

- e. **Hand Auger Borings:** Hand augers are often used to obtain shallow subsurface information from the site with difficult access or terrain that a vehicle cannot easily reach.
- f. **Exploration Pit Excavation:** Exploration pits and trenches permit detailed examination of the soil and rock conditions at shallow depths at relatively low cost. They can be used where significant variations in soil conditions, large soil, and/or non-soil materials exist (boulders, cobbles, debris, etc.) that cannot be sampled with conventional methods, or for buried features that must be identified.

D. Sampling

1. **Disturbed Sampling:** Disturbed samples are those obtained using equipment that destroys the macrostructure of the soil without altering its mineralogical composition. Specimens from these samples can be used to determine the general lithology of soil deposits, identify soil components and general classification purposes, and determine grain size, Atterberg limits, and compaction characteristics of soils. There are four well-known types of samplers for distributed samples, which are shown in Table 6B-1.01.

Table 6B-1.01: Types of Samplers (Disturbed)

Sampler	Appropriate Soil Types	Method of Penetration	Frequency of Use
Split-barrel (split-spoon)	Sands, silts, clays	Hammer-driven	Very frequent
Modified California	Sands, silts, clays, gravels	Hammer-driven (large split-spoon)	Rare
Continuous auger	Cohesive soils	Drilling with hollow stem augers	Rare
Bulk	Gravels, sands, silts, clays	Hand tools, bucket augering	Rare

2. **Undisturbed Sampling:** Clay and granular samples can be obtained with specialized equipment designed to minimize the disturbance to the in-situ structure and moisture content of the soils. Specimens obtained by undisturbed sampling methods are used to determine the strength, stratification permeability, density, consolidation, dynamic properties, and other engineering characteristics of soils. There are six types of samplers to obtain undisturbed samples, of which the thin-walled Shelby tube is the most common. These samplers are shown in Table 6B-1.02.

Table 6B-1.02: Types of Samplers (Undisturbed)

Sampler	Appropriate Soil Types	Method of Penetration	Frequency of Use
Thin-walled Shelby tube	Clays, silts, fine-grained soils, clayey sands	Mechanically or hydraulically pushed	Frequent
Continuous push	Sands, silts, clays	Hydraulic push with plastic lining	Less frequent
Piston	Silts, clays	Hydraulic push	Less frequent
Pitcher	Stiff to hard clay, silt, sand, partially weathered rock, and frozen or resin-impregnated granular soil	Rotation and hydraulic pressure	Rare
Denison	Stiff to hard clay, silt, sand, and partially weathered rock	Rotation and hydraulic pressure	Rare
Block	Cohesive soils and frozen or resin-impregnated granular soil	Hand tools	Rare

Testing

A. General Information

Several testing methods can be used to measure soil engineering properties. The advantages, disadvantages, and measured soil properties for each test are summarized below.

B. Field Testing

1. Types of In-situ Equipment:

- a. **Standard Penetration Test (SPT):** SPT test procedures are detailed in ASTM D 1586 and AASHTO T 206. The SPT consists of advancing a standard sampler into the ground, using a 140 pound weight dropped 30 inches. The sampler is advanced in three 6 inch increments, the first increment to seat the sampler. The SPT blow count is the number of blows required to advance the sampler into the final 12 inches of soil.

Advantages of the Standard Penetration Test are that both a sample and number are obtained; in addition, the test is simple and rugged, is suitable in many soil types, can perform in weak rocks, and is available throughout the U.S. Disadvantages are that index tests result in a disturbed sample, the number for analysis is crude, the test is not applicable in soft clay and silts, and there is high variability and uncertainty.

- b. **Cone Penetration Test (CPT):** The CPT test is an economical in-situ test, providing continuous profiling of geostatigraphy and soil properties evaluation. The steps can follow ASTM D 3441 (mechanical systems) and ASTM D 5778 (electronic system). The CPT consists of a small-diameter, cone-tipped rod that is advanced into the ground at a set rate. Measurements are made of the resistance to ground penetration at both the tip and along the side. These measurements are used to classify soils, estimate the friction angle of sands, and estimate the shear strength of soft clays.

Advantages of the Cone Penetration Test include fast and continuous profiling, economical and productive operation, non-operator-dependent results, a strong theoretical basis in interpretation, and particular suitability for soft soils. Disadvantages include a high capital investment, a skilled operator to run the test, unavoidable electronic drift noise and calibration, no collection of soil samples, and unsuitability to test gravel or boulder deposits.

- c. **Borehole Shear Test (BST):** BST is performed according to the instructions published by Handy Geotechnical Instruments, Inc.

Advantages of the Borehole Shear Test include its direct evaluation of soil cohesion (C), and friction angle (ϕ), at a particular depth, and its yielding of a large amount of soil cohesion and friction angle data in a short time. Disadvantages include difficulty to fix the test rate and the drainage condition of the sample, and no collection of stress-strain data.

- d. Flat Plate Dilatometer Test (DMT):** DMT is performed according to ASTM D 6635, which provides the overview of this device and its operation sequence.

Advantages of the Flat Plate Dilatometer Test are that it is simple and robust, results are repeatable and operator-independent, and it is quick and economical. Disadvantages are that it is difficult to push in dense and hard materials, it primarily relies on correlative relationships, and that it needs calibration for local geologies.

- e. Pressuremeter Test (PMT):** There are several types of pressuremeter procedures, such as Pre-bored-Menard (MPM), Self-boring pressuremeter (SBP), Push-in pressuremeter (PIP), and Full-displacement cone pressuremeter (CPM). Procedures and calibrations are given in ASTM D 4719.

Advantages of the Pressuremeter Test are that it is theoretically sound in determination of soil parameters, it tests a larger zone of soil mass than other in-situ tests, and it develops a complete curve. Disadvantages are that the procedures are complicated, it requires a high level of expertise in the field, it is time consuming and expensive (a good day yields 6 to 8 complete tests), and the equipment is delicate and easily damaged.

- f. Vane Shear Test (VST):** The instructions for the Vane Shear Test are found in ASTM D 2573.

Advantages of the Vane Shear Test are that it provides an assessment of undrained shear strength (S_u), the test and equipment are simple; it can measure in-situ clay sensitivity (S_t), and there is a long history of use in practice. Disadvantages are that application for soft-to-stiff clays is limited, and it is slow and time consuming. In addition, raw, undrained shear strength needs empirical correction and can be affected by sand lenses and seams.

- 2. Correlations with Soil Properties:** Tables 6B-2.01 and 6B-2.02 summarize the measured output values from each in-situ test, the use of the values to evaluate different soil properties, the soil types with which the tests can be used, and correlations used to evaluate soil properties.

Table 6B-2.01: In-situ Methods and General Application

Method	Output	Applicable Soil Properties	Applicable for Soil Properties	Applicable for Soil Types
SPT	N	Soil identification	Medium	Sands
		Establish vertical profile	Medium	
		Relative density (D_r)	Medium	
CPT	Cone resistance (q_c), Sleeve friction (f_s)	Establish vertical profile	Most	Silts, sands, clays, and peat
		Relative density (D_r)	Most	
		Angle of friction (ϕ')	Medium	
		Undrained shear strength (S_u)	Medium	
		Pore pressure (U)	Most	
		Modulus (E)	Medium	
		Compressibility	Medium	
		Consolidation	Most	
		Permeability (k)	Medium	
BST	σ and τ	Angle of friction (ϕ')	Most	Sands, silts and clays
		Cohesion (C')	Most	
DMT	$P_0, P_1, P_2, I_D, E_D, K_D$	Establish vertical profile	Most	Silts, sands, clays, and peat
		Soil identification	Medium	
		Relative density (D_r)	Medium	
		Undrained shear strength (S_u)	Medium	
PMT (pre-bored)	$V_0, V, \Delta P, \Delta V, E_p$	Soil identification	Medium	Clays, silts, and peat; marginal response in some sands and gravels
		Establish vertical profile	Medium	
		Angle of friction (ϕ')	Medium	
		Undrained shear strength (S_u)	Medium	
		Modulus (E & G)	Medium	
VST	T_{max}	Undrained shear strength (S_u)	Most	Clays, some silts, and peat (undrained condition); not for use in granular soils
		Soil identification	Medium	
		Overconsolidation ratio (OCR), K_0	Medium	
		Sensitivity (S_t)	Most	
		Pre-consolidation stress (P_C')	Medium	

Table 6B-2.02: Correlations Between In-situ Tests and Soil Properties

Method	Correlations	Applicable Soil Types
SPT	$\phi=28^\circ+15^\circ D_r$	Granular soils
	$\phi=0.45 N'_{70}+20$	Granular soils
	$q_u = kN_{70}$	Cohesive soils
CPT	$S_u = \frac{q_c - P_0}{N_k}$ ($P_0=\gamma z$, N_k =cone factor, from 5 to 75)	Cohesive soils
	$\phi=29^\circ + \sqrt{q_c}$	Granular soils
BST	$\tau=c+\sigma \tan \phi$	Cohesive soils
DMT	$K_o = \left(\frac{K_D}{\beta_D} \right)^\delta - C_D$	Granular and cohesive soils
PMT (pre-bored)	$K_o = \frac{p_h}{p_0}$	Cohesive soils
VST	$S_u = 0.2738 \frac{T}{d^3}$	Cohesive soils

C. Laboratory Testing

- Index Testing and Soil Classification:** AASHTO and ASTM standards for frequently used laboratory index testing of soils are summarized in Table 6B-2.03 below.

Table 6B-2.03: Index Testing and Soil Classification

Test	Test Designation		Applicable Soil Properties	Applicable Soil Types	Complexity
	AASHTO	ASTM			
Test method for determination of water content	T 265	D 4959	Void ratio (e) and unit	Gravels, sands, Silts, clays, peat	Simple
			weight (γ)		
Test method for specific gravity of soils	T 100	D 854	Specific gravity (G_s)	Sands, silts, Clays, peat	Simple
Method for particle-size analysis of soils	T 88	D 422	Classification	Gravels, sands, Silts	Simple
Test method for amount of material in soils finer than the No. 200 sieve		D 1140	Soil classification	Fine sands, Silts, clays	Simple
Test method for Liquid Limit, Plastic Limit, and Plasticity Index of soils	T 89	D 4318	Soil classification	Clays, silts, peat; silty and clayey sands to determine whether SM or SC	Simple
Unit weight, density		D 1587	Total density (e.g., wet density) (γ_t)	Undisturbed samples can be taken, i.e., silts, clays, peat	Simple
			Dry density (γ_d)		

2. **Shear Strength Testing:** AASHTO and ASTM standards for frequently used laboratory strength properties testing of soils are shown in Table 6B-2.04.

Table 6B-2.04: Shear Strength Tests

Test	Test Designation		Applicable Soil Properties	Applicable Soil Types	Complexity
	AASHTO	ASTM			
Unconfined compressive strength of cohesive soil	T 208	D 2166	Undrained shear strength (S_u)	Clays and silts	Simple
Unconsolidated, undrained compressive strength of clay and silt soils in tri-axial compression	T 296	D 2850	Undrained shear strength (S_u)	Clays and silts	Simple
Consolidated, undrained triaxial compression test on cohesive soils	T 297	D 4767	Friction angle (ϕ), Cohesion (C)	Clays and silts	Medium
Direct shear test of soils for consolidated drained conditions	T 236	D 3080	Friction angle (ϕ')	Compacted fill materials; sands, silts, and clays	Simple
Modulus and damping of soils by the resonant-column method (small-strain properties)		D 4015	Shear modulus (G_{max}), Damping (D)	Gravel, sand, silt, and clay	Complicated
Test method for laboratory miniature vane shear test for saturated fine-grained clayey soil		D 4648	Undrained shear strength (S_u) Clay sensitivity (S_t)	Silts and clays	Simple
Test method for CBR (California Bearing Ratio) of laboratory-compacted soils		D 1883	Bearing capacity of a compacted soil	Gravels, sands, silts, and clays	Complicated
Test method for resilient modulus of soils	T 294		Relations between applied stress and deformation of pavement materials	Gravels, sands, silts, and clays	Time consuming
Method for resistance R-value and expansion pressure of compacted soils	T 190	D 2844	Resist lateral deformation resistance	Gravels, sands, silts, and clays	Complicated

3. **Settlement Testing:** AASHTO and ASTM standards for frequently used laboratory compression properties of soils are summarized in Table 6B-2.05.

Table 6B-2.05: Laboratory Test Used to Measure the Compression Properties of Soils

Test	Test Designation		Applicable Soil Types	Complexity
	AASHTO	ASTM		
Method for one-dimensional consolidation properties of soils (oedometer test)	T 216	D 2435	Primarily clays and silts	Simple but time consuming
Test methods for one-dimensional swell or settlement potential of cohesive soils	T 256	D 4546	Clays	Medium
Test method for measurement of collapse potential of soils		D 5333	Silts	Medium

Geotechnical Report

A. Geotechnical Report

The results of the explorations and laboratory testing are usually presented in the form of a geology and soils report. This report should contain sufficient descriptions of the field and laboratory investigations performed, the conditions encountered, typical test data, basic assumptions, and the analytical procedures utilized; to allow a detailed review of the conclusions, recommendations, and final pavement design. The amount and type of information to be presented in the design analysis report should be consistent with the scope of the investigation. For pavements, the following items (when applicable) should be included and used as a guide in preparing the design analysis report:

1. A general description of the site, indicating principal topographic features in the vicinity. A plan map should show surface contours, the locations of the proposed structure, and the location of all borings.
 2. A description of the general geology of the site, including the results of any previous geologic studies performed.
 3. The results of field investigations, including graphic logs of all foundation borings, locations of pertinent data from piezometers (when applicable), depth to bedrock, and a general description of the subsurface materials based on the borings. The boring logs or report should indicate how the borings were made, the type of sampler used, and any penetration test results, or other field measurement data taken on the site.
 4. Groundwater conditions, including data on seasonal variations in groundwater level and results of field pumping tests, if performed.
 5. Computation of the resilient modulus for the total vertical and horizontal stresses using the constitutive relationship.
 6. A generalized soil profile used for design, showing average or representative soil properties and values of design shear strength used for various soil strata. The profile may be described in writing or shown graphically.
 7. Recommendations on the type of pavement structure and any special design feature to be used, including removal and replacement of certain soils and stabilization of soils or other foundation improvements, and treatments.
 8. Basic assumptions, imposed wheel loads, results of any settlement analyses, and an estimate of the maximum amount of swell to be expected in the subgrade soils. The effects of the computed differential settlement, and also the effects of the swell on the pavement structure, should be discussed.
 9. Special precautions and recommendations for construction techniques. Locations at which material for fill and backfill can be obtained should also be discussed as well as the amount of compaction required and procedures planned for meeting these requirements.
- In summary, the horizontal and vertical variations in subsurface soil types, moisture contents,

densities, and water table depths should be identified for both new and existing pavements. FHWA Report No. FHWA-RD-97-083 (VonQuintus and Killingsworth 1997) provides general guidance and requirements for subsurface investigations for pavement design and evaluations for rehabilitation designs. Each soil stratum encountered should be characterized for its use to support pavement structures and whether the subsurface soils would impose special problems for the construction and long-term performance of pavement structures.

B. References

VonQuintus, H.L. and B.M. Killingsworth. *Design Pamphlet for the Determination of Design Subgrade in Support of the 1993 AASHTO Guide for the Design of Pavement Structures*. McLean, VA: Publication No. FHWA-RD-97-083. 1997.

Additional Resources:

Geotechnical Bulletin. *Plan Subgrades*. Ohio: Ohio Department of Transportation Division of Planning. 2003.

Mayne, P.W., B.R. Christopher, and J. DeJong. *Subsurface Investigation*. Washington, DC: National Highway Institute Federal Highway Administration, Report No. FHWA-NHI-01031, U.S. DOT. 2002.

Skok, E.L., E.N. Johnson, and M. Brown. *Special practices for design and construction of subgrades in poor, wet, and/or saturated soil condition*. Minnesota: Report No. MN/RC-2003-36, Minnesota Department of Transportation. 2003.

Pavement Systems

A. General Information

This section addresses the importance of pavement foundations and the potential for pavement problems due to deficient foundation support.

1. **Pavement System:** Consists of the pavement and foundation materials, which are layers of subbase, and subgrade (see Figure 6C-1.01). Failure to properly design or construct any of these components often leads to reduced serviceability or premature failure of the system.
2. **Pavement Materials:** Consist of flexible or rigid pavements, typically HMA or PCC, respectively, or a composite of the two.
3. **Subbase:** Consists of the granular materials underlying the pavement and above the subgrade layer.
4. **Subgrade:** Consists of the naturally occurring material on which the road is built, or the imported fill material used to create an embankment on which the road pavement is constructed. Subgrades are also considered layers in the pavement design, with their thickness assumed to be infinite and their material characteristics assumed to be unchanged or unmodified. Prepared subgrade is typically the top 12 inches of subgrade.

Figure 6C-1.01: Pavement System Cross-section

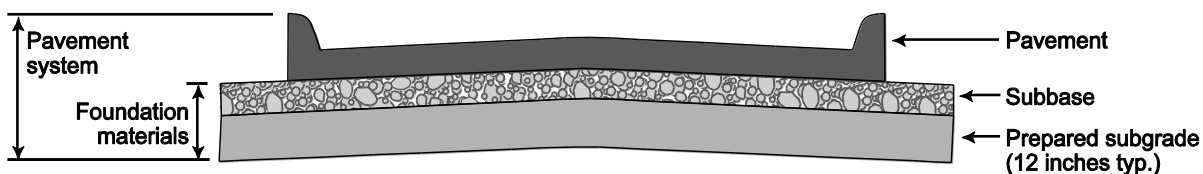

B. Pavement Support

The prepared subgrade is the upper portion (typically 12 inches) of a roadbed upon which the pavement and subbase are constructed. Pavement performance is expressed in terms of pavement materials and thickness. Although pavements fail from the top, pavement systems generally start to deteriorate from the bottom (subgrade), which often determines the service life of a road. Subgrade performance generally depends on two interrelated characteristics:

1. **Load-bearing Capacity:** The ability to support loads is transmitted from the pavement structure, which is often affected by degree of compaction, moisture content, and soil type.
2. **Volume Changes of the Subgrade:** The volume of the subgrade may change when exposed to excessive moisture or freezing conditions.

In determining the suitability of a subgrade, the following factors should be considered:

- General characteristics of the subgrade soil
- Depth to bedrock
- Depth to water table
- Compaction that can be attained in the subgrade
- CBR values of uncompacted and compacted subgrades
- Presence of weak or soft layers or organics in the subsoil
- Susceptibility to detrimental frost action or excessive swell

C. Pavement Problems

There are a number of ways that a pavement section can fail as well as many mechanisms, which lead to distress and failure.

1. Pavement Failures:

- a. **Structural Failure:** Occurs when a collapse of the entire structure or a breakdown of one or more of the pavement components renders the pavement incapable of sustaining the loads imposed on its surface.
- b. **Functional Failure:** Occurs when the pavement, due to its roughness, is unable to carry out its intended function without causing discomfort to drivers or passengers or imposing high stresses on vehicles.

2. **Foundation Failures:** The cause of these failure conditions may be due to inadequate maintenance, excessive loads, climatic and environmental conditions, poor drainage leading to poor subgrade conditions, non-uniform support of the surface layer, poor subgrade soil, and disintegration of the component materials. Utility cuts through existing pavements also result in premature pavement failure if not properly restored. Excessive loads, excessive repetition of loads, and high tire pressures can also cause either structural or functional failures.

Pavement failures may occur due to the intrusion of subgrade soils into the granular subbase, which results in inadequate drainage and reduced stability. Distress may also occur due to excessive loads that cause a shear failure in the subgrade, subbase, or surface layer. Other causes of failures are surface fatigue and excessive settlement, especially differential settlement of the subgrade. Volume change of subgrade soils due to wetting and drying, freezing and thawing, or improper drainage may also cause pavement distress. Inadequate drainage of water from the subbase and subgrade is a major cause of pavement problems. If the subgrade is saturated, excess pore pressures will develop under traffic loads, resulting in subsequent softening of the subgrade. Under traffic (dynamic) loading, fines can be pumped up into the subbase layers.

Improper construction practices may also cause pavement distress. Wetting of the subgrade during construction may permit water accumulation and subsequent softening of the subgrade in the rutted areas after construction is completed. Use of dirty aggregates or contamination of the subbase aggregates during construction may produce inadequate drainage, instability, and frost susceptibility. Reduction in design thickness during construction due to insufficient subgrade preparation may result in undulating subgrade surfaces, failure to place proper layer thicknesses, and unanticipated loss of subbase materials due to subgrade intrusion. A major cause of pavement deterioration is inadequate Quality Control/Quality Assurance (QA/QC) of pavement materials and pavement surface during construction. The following are the some of the significant causes leading to pavement distress and failure:

- a. **Poor Soils:** Poor soils can seriously impede construction of adequate subgrades, as well as affect the long-term performance of a pavement during its service life. In use as subgrades, these soils often lack the strength and stability necessary to support trucks hauling construction materials, which forces project delays and adds costs. Special problem soil conditions include frost heave-susceptible soils, swelling or expansive soils, and collapsible soils.

Highly compressible (very weak) soils are susceptible to large settlements and deformations with time that can have a detrimental effect on pavement performance. Highly compressible soils are very low in density, saturated, and are usually silts, clays, peat, organic alluvium, or loess. If these compressible soils are not treated properly, large surface depressions with random cracking can develop. The surface depressions can allow water to pond on the pavement's surface and more readily infiltrate the pavement structure, compounding a severe problem. More importantly, the ponding of water will create a safety hazard to the traveling public during wet weather. The selection of a particular treatment technique for poor soils is discussed in [Section 6H-1 - Foundation Improvement and Stabilization](#).

As with highly compressible soils, collapsible soils can lead to significant localized settlement of the pavement. Collapsible soils are very low-density silt-type soils, usually alluvium or wind-blown (loess) deposits, and are susceptible to sudden decreases in volume when wetted. Often, their unstable structure has been cemented by clay binders or other deposits, which will dissolve upon saturation, allowing a dramatic decrease in volume. Native subgrades of collapsible soils need to be soaked with water prior to construction and rolled with heavy compaction equipment. In some cases, residual soils may also be collapsible due to leaching of colloidal and soluble materials. If pavement systems are to be constructed over collapsible soils, special remedial measures may be required to prevent large-scale cracking and differential settlement.

Swelling or expansive soils are susceptible to volume change (shrink and swell) with seasonal fluctuations in moisture content. The magnitude of this volume change is dependent on the type of soil (shrink-swell potential) and its change in moisture content. A loss of moisture will cause the soil to shrink, while an increase in moisture will cause it to expand or swell. This volume change of clay-type soils can result in longitudinal cracks near the pavement's edge and significant surface roughness (varying swells and depressions) along the pavement's length. Expansive soils are a significant problem in many parts of the United States and are responsible for premature maintenance and rehabilitation. Expansive soils are especially a problem when deep cuts are made in a dense (over-consolidated) clay soil.

- b. **Utility Cuts:** The impact of utility cuts on pavement performance has been a concern of public agencies for many years. In large cities, thousands of utility cuts are made every year. These cuts are made to install, inspect, or repair buried facilities (See [Chapter 9 - Utilities](#)).

The results of studies conducted by public agencies show that the presence of utility cuts lower measured pavement condition scores (indexes) compared to pavements of the same age with no utility cuts. The link between the presence of utility cuts and accelerated pavement deterioration is understood by most agencies.

The resulting reduction in pavement life, despite high-quality workmanship repairing the cut can be explained by the trenching operation. The process of opening the trench causes sagging or slumping of the trench sides as the lateral support of the soil is removed. This zone of weakened pavement adjacent to the utility cut (known as the zone of influence) can fail more rapidly than other parts of the pavement. This can be observed in the field by the

presence of fatigue (alligator) cracking occurring around the edges of the cut or spalling around the cut edges.

- c. Transition Between Cuts and Fills:** The alignment for many roadway projects does not always follow the site topography, and consequently a variety of cuts and fills will be required. The geotechnical design of the pavement will involve additional special considerations in cut-and-fill areas. Attention must also be given to transition zones (e.g., between a cut and an at-grade section) because of the potential for non-uniform pavement support and subsurface water flow.

The main additional concern for cut sections is drainage, as the surrounding site will be sloping toward the pavement structure; and the groundwater table will generally be closer to the bottom of the pavement section in cuts. Stabilization of moisture-sensitive natural foundation soils may also be required. Stability of the cut slopes adjacent to the pavement will also be an important design issue, but one that is treated separately from the pavement design itself.

The embankments for fill sections are constructed from compacted material, and in many cases, this construction results in a higher-quality subgrade than the natural foundation soil. In general, drainage and groundwater issues will be less critical for pavements on embankments, although erosion of side slopes from pavement runoff may be a problem, along with long-term infiltration of water. The primary additional concern for pavements in fill sections will be the stability of the embankment slopes and settlements, either due to compression of the embankment itself or to consolidation of soft foundation soils beneath the embankment. This is usually evaluated by the geotechnical unit as part of the roadway embankment design (see [Section 6D-1 - Embankment Construction](#)).

- d. Foundation Non-uniformity:** Non-uniform subgrade/subbase support increases localized deflections and causes stress concentrations in the pavement, which can lead to premature failures, fatigue cracking, faulting, pumping, rutting, and other types of pavement distresses for rigid and flexible pavement systems. Some recognized direct causes of subgrade/subbase non-uniformity include the following.
- Expansive soils
 - Differential frost heave and subgrade softening
 - Non-uniform strength and stiffness, due to variable soil type, moisture content, and density
 - Pumping and rutting
 - Cut/fill transitions
 - Poor grading

Some techniques to overcome these subgrade deficiencies are:

- Moisture-density control during construction
- Proper soil identification and placement
- Over-excavation and replacement with select materials
- Mechanical and chemical soil stabilization
- Onsite soil mixing to produce well-graded composite materials
- Good grading techniques (e.g., uniform compaction energy/lift thickness)
- Waterproofing of the subgrade and control of moisture fluctuations

Although emphasis is placed on subgrade stiffness (i.e., modulus of subgrade reaction, k) for designing PCC thickness, performance monitoring suggests that uniformity of stiffness is the key for ensuring long-term performance. Because of the relatively high flexural stiffness of PCC pavements, the subgrade does not necessarily require high strength, but the subgrade/subbase should be uniform with no abrupt changes in degree of support. The uniformity has a significant influence on the stress intensity and deflection of the pavement layer, and the magnitude of stresses in the upper pavement layer depends on a combination of traffic loads and uniformity of subgrade support. Non-uniform stiffness and the resulting stress intensity contribute to fatigue cracking and differential settlement (deflection) in the pavement layer, and eventually to an uneven pavement surface. This uneven surface causes a rough ride for traffic and contributes to early pavement deterioration and high maintenance costs.

- e. **Poor Moisture Control:** Pavements are strongly influenced by moisture and other environmental factors. Water migrates into the pavement structure through a combination of surface infiltration (e.g., through cracks in the surface layer), edge inflows, and from the underlying groundwater table (e.g., via capillary potential in fine-grained foundation soils). In cold environments, the moisture may undergo seasonal freeze/thaw cycles. Moisture within the pavement system nearly always has detrimental effects on pavement performance. It reduces the strength and stiffness of the pavement foundation materials, promotes contamination of coarse granular material due to fines migration, and can cause swelling (e.g., frost heave and/or soil expansion) and subsequent consolidation. Moisture can also introduce substantial spatial variability in the pavement properties and performance, which can be manifested either as local distresses like potholes, or more globally as excessive roughness. The design of the geotechnical aspects of pavements must consequently focus on the selection of moisture-insensitive, free-draining subbase materials, stabilization of moisture-sensitive subgrade soils, and adequate drainage of any water that does infiltrate into the pavement system.

To avoid moisture-related problems, a major objective in pavement design should seek to prevent the subbase, subgrade, and other susceptible paving materials from becoming saturated, or even exposed to constantly high-moisture levels. The three common approaches for controlling or reducing the problems caused by moisture include:

- Preventing moisture from entering the pavement system.
- Using materials and design features that are insensitive to the effects of moisture.
- Quickly removing the moisture that enters the pavement system.

No single approach can completely negate the effects of moisture on the pavement system under heavy traffic loading over many years. For example, it is practically impossible to completely seal the pavement, especially from moisture that may enter from the sides or beneath the pavement section. While materials can be incorporated into the design which are insensitive to moisture, this approach is often costly and in many cases not feasible (e.g., may require replacing the subgrade). Drainage systems also add costs to the road, as maintenance is required to maintain drainage systems as well as to seal systems for effective performance over the life of the system. Thus, it is often necessary to employ all approaches in combination for critical design situations.

Embankment Construction

A. General Information

Quality embankment construction is required to maintain smooth-riding pavements and to provide slope stability. Proper selection of soil, adequate moisture control, and uniform compaction are required for a quality embankment. Problems resulting from poor embankment construction have occasionally resulted in slope stability problems that encroach on private property and damage drainage structures. Also, pavement roughness can result from non-uniform support. The costs for remediation of such failures are high.

Soils available for embankment construction in Iowa generally range from A-4 soils (ML, OL), which are very fine sands and silts that are subject to frost heave, to A-6 and A-7 soils (CL, OH, MH, CG), which predominate across the state. The A-6 and A-7 groups include shrink/swell clayey soils. In general, these soils rate from poor to fair in suitability as subgrade soils. Because of their abundance, economics dictate that these soils must be used on the projects even though they exhibit shrink/swell properties. Because these are marginal soils, it is critical that the embankments be placed with proper compaction and moisture content, and in some cases, stabilization (see [Section 6H-1 - Foundation Improvement and Stabilization](#)).

Soils for embankment projects are identified during the exploration phase of the construction process. Borings are taken periodically along the proposed route and at potential borrow pits. The soils are tested to determine their engineering properties. Atterberg limits are determined and in-situ moisture and density are compared to standard Proctor values. However, it is impossible to completely and accurately characterize soil profiles because of the variability between boring locations. It is necessary for field staff and contractors to be able to recognize that soil changes have occurred and make the proper field adjustments.

Depending on roller configuration, soil moisture content, and soil type, soils may be under- or over-compacted. If soil lifts are too thick, the “Oreo cookie effect” may result, where only the upper part of the lift is being compacted. If the soils are too wet, over-compaction from hauling equipment can occur with resultant shearing of the soil and building in shear planes within the embankment, which can lead to slope failure.

Construction with soil is one of the most complicated procedures in engineering. In no other field of engineering are there so many variables as to the material used for construction. It is also widely recognized that certain soils are much more suitable for some construction activities than others.

A general understanding of soil and its different properties is essential for building a quality embankment. The engineering properties of a soil can vary greatly from gravel to clays. In order to build a quality embankment, the specific properties of the soil being used must be understood in order to make proper field judgments.

Ongoing debate exists among practitioners in geotechnical engineering about whether to compact soil wet-of-optimum-moisture content or dry-of-optimum moisture content. There is no decisive answer to this question. The only correct answer is that the ideal moisture content depends on material type and the desired characteristics (which often are competing) of the embankment. Strength, stability, density, low permeability, low shrink/swell behavior, and low collapsibility are all desired outcomes

of a quality embankment.

Strength is obviously a desirable characteristic and is a function of many factors but can be directly related to moisture content. The U.S. Army Corps of Engineers (USACE) used the California Bearing Ratio (CBR) as an efficient measurement of strength in cohesive soils. The USACE reports, “the unsoaked CBR values are high on the dry side of optimum, but there is a dramatic loss in strength as molding moisture content is increased” (Ariema and Butler 1990; Atkins 1997). Hilf (1956) produced the same results from tests using penetration resistance as a measure of strength. When a soil is in a dry state, it exhibits high strength due to an appreciable inter-particle, attractive force created by high curvature of the menisci between soil particles. However, further wetting greatly reduces this friction strength by lubrication of the soil particles. Alternatively, in cohesionless soils, the strength is not as significantly affected by an increase in moisture, due to its high hydraulic conductivity.

Stability is a second desirable characteristic. However, stability cannot be defined as one characteristic. There is stability related to strength, which reacts to moisture contents described above; and there is also volumetric stability. When dealing with highly plastic clays, this is an extremely important factor since these clays exhibit shrink/swell behavior with a change in moisture content. Swelling of clays causes more damage in the United States than do the combined effects of all other natural disasters. It is general practice when dealing with fat clays to place the fill wet of optimum. This basically forces the clay to swell before compacting it in the embankment. Moisture content becomes important in cohesionless materials with respect to volumetric stability when the bulking phenomenon is considered. At the bulking moisture content, a cohesionless soil will undergo volumetric expansion, or “bulk” (see [Section 6A-2 - Basic Soils Information](#)). Additionally, the material will exhibit apparent cohesion, and compaction cannot be achieved. Therefore, in terms of volumetric stability, truly cohesionless materials should be compacted when dry or saturated.

Density is perhaps the characteristic most widely associated with embankment construction. The Proctor test is the most widely used laboratory test to determine maximum dry density and optimum moisture content of cohesive soils as a function of compaction energy. However, the standard Proctor test is not a valid test for all cohesionless soils. Cohesionless soils require the relative density test to determine a maximum and minimum dry density.

Once the desirable material properties have been identified, the next process in building a quality embankment is the correct placement of the soil. The importance of soil preparation before rolling is not adequately appreciated. Blending of the soil to achieve a homogeneous composition and moisture content is essential for quality embankment construction. Proper roller identification and use are also essential. Not all rollers are adequate for all soil types. Sheepsfoot rollers are ideal for cohesive soils, while vibratory rollers must be used on cohesionless materials. Inter-grade soils require inter-grade rollers, such as a vibratory sheepsfoot (Chatwin et al. 1994).

B. Site Preparation

1. **Clearing and Grubbing:** The site should be prepared by first clearing the area of vegetation, fencing rubbish, and other objectionable materials.
2. **Stripping, Salvaging, and Spreading Topsoil:** The site should be mowed and any sod shredded by shallow plowing or blading and thorough disking so the soil can be easily placed in a thin layer over areas to be covered.

An adequate amount of topsoil should be removed from the upper 12 inches of existing onsite topsoil to allow a finished grade of 8 inches of salvaged or amended topsoil. The topsoil may be moved directly to an area where it is to be used or may be stockpiled for future use. If existing topsoil lacks adequate organic content, off-site soil may be required, or existing topsoil may be blended with compost (see [SUDAS Specifications Section 2010, 2.01](#) for proper blending ratios).

C. Design Considerations

1. **Slope Stability Evaluation:** Foundation soils and embankments provide adequate support for roadways and other transportation infrastructure if the additional stress from traffic loads and geo-structures does not exceed the shear strength of the embankment soils or underlying strata (Ariema and Butler 1990). Overstressing the embankment or foundation soil may result in rotational, displacement, or translatory failure, as illustrated in Figure 6D-1.01.

Factors of safety are used to indicate the adequacy of slope stability and play a vital role in the rational design of engineered slopes (e.g. embankments, cut slopes, landfills). Factors of safety used in design account for uncertainty and thus guard against ignorance about the reliability of the items that enter into the analysis, such as soil strength parameter values, pore water pressure distributions, and soil stratigraphy (Abramson et al. 2002). As with the design of other geostructures, higher factors of safety are used when limited site investigation generates uncertainty regarding the analysis input parameters. Investment in more thorough site investigation and construction monitoring, however, may be rewarded by acceptable reduction in the desired factor of safety. Typically minimum factors of safety for new embankment slope design range from 1.3 to 1.5. Factors of safety against slope instability are defined considering the likely slope failure mode and the strength of slope soils.

Figure 6D-1.01: Typical Embankment Failures

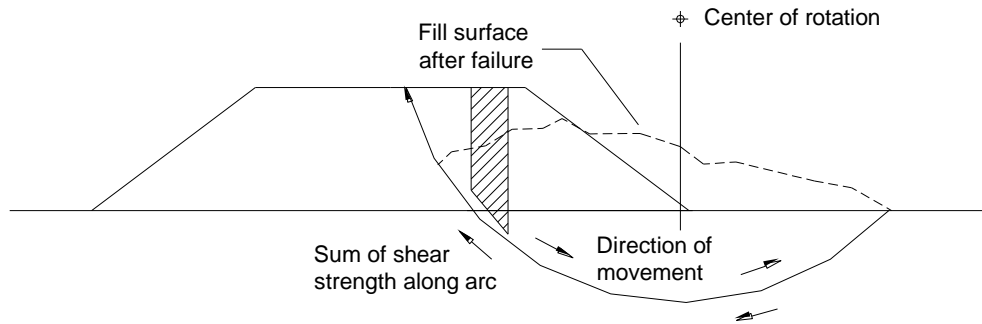

ROTATIONAL FAILURE

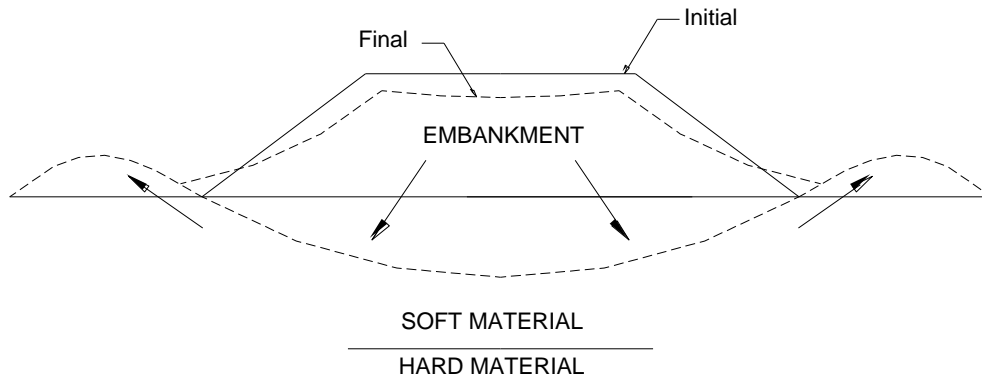

DISPLACEMENT FAILURE

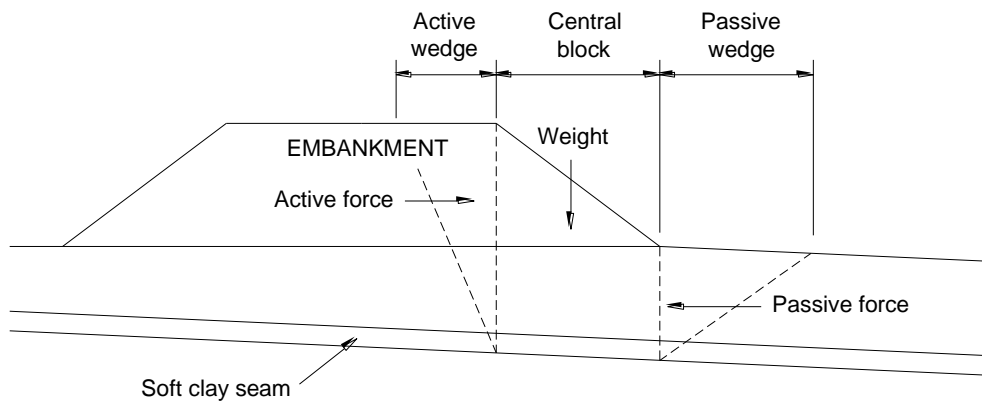

TRANSLATORY FAILURE

Source: Ariema and Butler 1990

2. **Causes of Slope Instability:** Stable slopes are characterized by a balance between the gravitational forces tending to pull soils downslope and the resisting forces comprised of soil shear strength. The state of temporary equilibrium may be compromised when the slope is subject to de-stabilizing forces. The factors affecting slope stability may include those that increase the gravitational force (e.g. slope geometry, undercutting, surcharging) or those that reduce soil shear strength (e.g. weathering, pore water pressure, vegetation removal) (Chatwin et al. 1994).
3. **Slope Stability Problems in Iowa:** Slope instability poses problems for roadway systems in Iowa. Failures occur on both new embankments and cut slopes. The failures occur because identifying factors that affect stability at a particular location, such as soil shear strength parameter values, ground water surface elevations, and negative influences from construction activities, are often difficult to discern and measure. Hazard identification is a cornerstone of landslide hazard mitigation (Spiker and Gori 2003). Once a failure occurs or a potential failure is identified (i.e. low factor of safety), roadway agencies need information and knowledge of which methods of remediation will be most effective to stabilize the slope. Ideally, these stability problems can be discovered and addressed before a slope failure occurs.

Approximately 50% of slope remediation projects involve changes in slope geometry (in effect, creating a stability berm). The design and construction of stability berms have historically been a simple and effective option of departments of transportation for preserving transportation infrastructure.

4. **Stabilization Methods:** A number of methods are available to stabilize slopes, including re-grading to flatten the slope; construction of stability berms; the use of lightweight fill, geofoam or shredded tires to reduce the load; and structural reinforcing methods such as geosynthetic reinforcements, stone columns, rammed aggregate piers, soil nailing, and piles. Additional information on such methods to address slope instability can be found in [Section 6H-1 - Foundation Improvement and Stabilization](#).

D. Equipment

Table 6D-1.01 provides suggested compaction equipment and compacted lift thicknesses for coarse- and fine-grained soils, according to the USCS and AASHTO soil classification systems.

Table 6D-1.01: Recommended Field Compaction Equipment

Soil	First Choice	Second Choice	Comment
Rock fill	Vibratory	Pneumatic	--
Plastic soils, CH, MH	Sheepsfoot or pad foot	Pneumatic	Thin lifts usually needed
Low-plasticity soils, CL, ML	Sheepsfoot or pad foot	Pneumatic, vibratory	Moisture control often critical for silty soils
Plastic sands and gravels, GC, SC	Vibratory, pneumatic	Pad foot	--
Silty sands and gravels, SM, GM	Vibratory	Pneumatic, pad foot	Moisture control often critical
Clean sands, SW, SP	Vibratory	Impact, pneumatic	--
Clean gravels, GW, GP	Vibratory	Pneumatic, impact, grid	Grid useful for over-size particles

Source: Rollings and Rollings 1996

E. Density

Maximum Dry Density: Compaction requirements are measured in terms of the dry density of the soil. The expected value for dry density varies with the type of soil being compacted. For example, a clay soil may be rolled many times and not reach 125 pcf, whereas a granular soil may have a dry density above this value without any compactive effort. Therefore, a value for the maximum possible dry density must be established for each soil (Atkins 1997).

For any compactive effort, the dry density of a soil will vary with its water content. A soil compacted dry will reach a certain dry density. If compacted again with the same compactive effort, but this time with water in the soil, the dry density will be higher, since the water lubricates the grains and allows them to slide into a denser structure. Air is forced out of the soil, leaving more space for the soil solids, as well as the added water. With even higher water content, a still greater dry density may be reached since more air is expelled. However, when most of the air in the mixture has been removed, adding more water to the mixture before compaction results in a lower dry density, as the extra water merely takes the place of some of the soil solids. This principle is illustrated in Figure 6D-1.02.

Figure 6D-1.02: Variation of Dry Density with Water Content

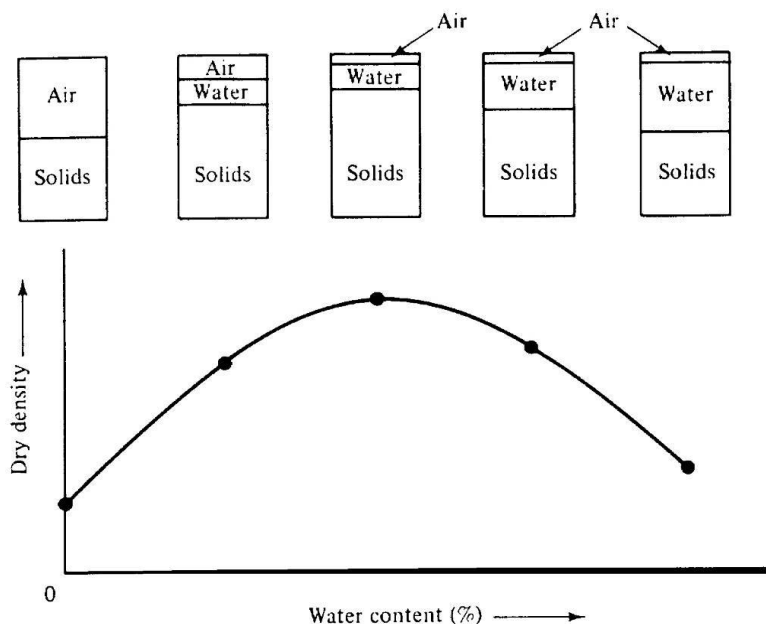

The first step in compaction control is to determine the maximum dry density that can be expected for a soil under a certain compactive effort, and the water content at which this density is reached. These are obtained from a compaction curve, as discussed in [Section 6A-2 - Basic Soils Information](#). The compaction curve is also called a moisture-density curve or a Proctor curve (named after the originator of the test). The curve is plotted from the results of the compaction test. Dry density is plotted against water content, and a curve is drawn through the test points. The top of the curve represents the maximum dry density for the soil with the test compactive effort and the corresponding water content, which is called the optimum water content (W_o).

F. Compaction

In-situ soils used as subgrades for the construction of roadway pavements or other structures and transported soils used in embankments or as leveling material for various types of construction projects are usually compacted to improve their density and other properties. Increasing the soil's density improves its strength, lowers its permeability, and reduces future settlement.

The evaluation of the density reached as a result of compactive efforts with rollers and other types of compaction equipment is the most common quality-control measurement made on soils at construction sites. The density of the soil as compacted is measured and compared to a density goal for that soil, as previously determined in laboratory tests. The moisture-density relationships for fine-grained (cohesive) soils and coarse-grained (cohesionless) soils are discussed in [Section 6A-2 - Basic Soils Information](#).

1. **Compaction of Fine-grained Soils:** The compaction method for a fine-grained soil is entirely different than that for a coarse-grained soil. The reason is that fine-grained soils possess cohesion. It should be remembered that the finer fraction of the fine-grained soils exists in a colloidal state, and all colloids possess cohesion. The mineral grains of a cohesive soil are not in physical contact, as they are in a coarse-grained soil. Every grain is surrounded by a blanket of water, whose molecules are electrically bonded to the grains. This blanket of water isolates the grains and prevents them from being in physical contact with adjacent grains (Duncan 1992).

The degree to which a fine-grained soil can be compacted is almost wholly dependent on the in-situ moisture content of the soil. The moisture content that corresponds to the maximum degree of compaction (under a given compaction energy) is called the optimum moisture content. The approximate optimum moisture content of several soil groups is given in Table 6D-1.02.

Table 6D-1.02: Maximum Dry Density and Optimum Moisture Content
(Typical for Standard Compaction Energy)

AASHTO Classification	Maximum Dry Density (pcf)	Moisture Content (%)
A-1	115-135	7-15
A-2	110-135	9-18
A-3	110-115	10-18
A-4	95-130	10-20
A-5	85-100	15-30
A-6	95-120	10-25
A-7	85-115	15-30

2. **Compaction of Coarse-grained Soils:** The method behind why compaction works for a coarse-grained soil is entirely different than that for a fine-grained soil. Coarse-grained soils exist by their very nature in inter-granular contact, much like a bucket of marbles. The way these grains are arranged within the mass and the distribution of particle size throughout the mass, will ultimately determine the density, stability, and load-bearing capacity of that particular soil (Duncan 1992).

The honeycombed structure shown in Figure 6D-1.03a is representative of very poor inter-granular seating. Such a structure is inherently unstable and can collapse suddenly when subjected to shock or vibration. The stability and load-bearing capacity of this type of soil will be improved by compaction because of the resulting rearrangement in inter-granular seating. With sufficient compaction, this structure will take on the characteristics of the arrangement shown in Figure 6D-1.03c.

The arrangement of particles shown in Figure 6D-1.03b provides maximum inter-granular contact, but there are insufficient fines to lock the larger particles in place. Compaction of this type of arrangement is ineffective, since neither additional particle contact nor additional stability can be achieved. This soil is inherently stable, however, when it is laterally restrained, and demonstrates good load-bearing characteristics. When insufficiently restrained, however, this soil will be free to move laterally, in which case there is a pronounced loss in stability and load-bearing characteristics.

The arrangement of particles shown in Figure 6D-1.03c not only provides maximum inter-granular contact, but also inherent stability. This very important property of stability is due to the inclusion of fines in the spaces between the larger particles. One cautionary note must be made concerning fines: too many fines are detrimental to the mix because they may separate the larger grains, thereby destroying the inter-granular contact between them. In this instance, the larger grains are more or less floating in a sea of fines.

Figure 6D-1.03: Inter-granular Seating and Gradation of Coarse-grained Particles

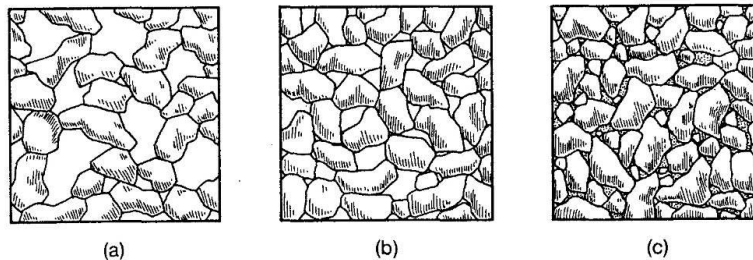

- (a) **Poorly graded, poorly seated particles**
 (b) **Poorly graded, but well-seated**
 (c) **Well-graded and well-seated particles**

The inter-granular seating of a coarse-grained soil can be improved by the process of compaction. Particle distribution can be improved by the physical addition and mixing of fines into the soil. Both of these separate actions increase the density of the soil. Density is a function of the amount of voids contained within a given volume of soil. The potential for a soil to be further densified depends upon how much of a reduction can be made in the void ratio. This reduction is not without limit. Every mixture of granular material inherently has a minimum void ratio (maximum density), and for a given mixture, this ratio cannot be changed. Once a soil has been compacted to its maximum density, continued efforts at compaction will only result in the crushing of the individual grains as described in [Section 6A-2 - Basic Soils Information](#).

Compaction of coarse-grained soils is usually considered to be adequate when the relative density of the soil in place is no less than some specified percentage of its maximum possible density. Relative density is a term used to numerically compare the density of an in-place natural or compacted soil, with the densities represented by the same soil in the extreme states of looseness and denseness, as described in [Section 6A-2 - Basic Soils Information](#).

- 3. Compaction of Mixed-grained Soils:** Natural deposits of soil frequently contain gravel, sand, silt, and clay in various proportions. Such soils are referred to as mixed-grained. Soils that are mixed-grained will, in all likelihood, exhibit some of the characteristics of both coarse-grained and fine-grained soils. The deciding factor as to whether a particular soil should be compacted according to coarse-grained or fine-grained requirements is that of cohesion (true or apparent) (Duncan 1992).

- a. **Soils that do not Exhibit any Measurable Cohesion:** Treat as coarse grained soil; base compaction on the relative density.
- b. **Soils that do Exhibit Measurable Cohesion:** Treat as fine-grained soil; base compaction on the Proctor Density Test.
- c. **Inter-grade Soils:** Conduct both Relative Density and Proctor Density Tests; base compaction on the test method yielding the highest maximum density.

G. Embankment Soils

SUDAS classifies Iowa cohesive soils into select subgrade materials, suitable soils, or unsuitable soils, depending on soil index properties and Proctor test results. See [Section 6E-1 - Subgrade Design and Construction](#) for more information.

1. **Select Subgrade Soils:** Select materials (see [Section 6E-1 - Subgrade Design and Construction](#)) or subgrade treatments (see [Section 6H-1 - Foundation Improvement and Stabilization](#)) may be used in the prepared subgrade (the top 12 inches immediately below the pavement or subbase, if present) to provide adequate volumetric stability, low frost potential, and good bearing capacity as it relates to the California Bearing Ratio ($CBR \geq 10$).
2. **Suitable Soils:** Suitable soils are used throughout the fill and under the prepared subgrade. Suitable soils may be used in the prepared subgrade if they meet the requirements of select subgrade soils or are stabilized to meet those requirements (i.e., $CBR \geq 10$). Suitable soils must meet all of the following conditions:
 - a. Standard Proctor Density ≥ 95 pcf
 - b. Group index < 30 (AASHTO M 145)
3. **Unsuitable Soils:** The SUDAS Specifications do not allow use of unsuitable soils in the right-of-way. However, there may be situations where the Engineer might consider the placement of unsuitable soils in the right-of-way. The Iowa DOT allows this placement. Figure 6D-1.04, modified from [Iowa DOT Standard Road Plan EW-102](#), illustrates Iowa DOT's guidance for the use of unsuitable soils in an urban embankment section.

Figure 6D-1.04: Placement of Unsuitable Soils

<p>Placed 4 feet below subgrade in fills outside curbline</p>	<p>1. Broken PCC in 6 inch sizes or smaller (pulverized HMA may be used as subgrade replacement)</p>
<p>Type A Placement Place in layers (8 inch max. thickness) 5 feet below subgrade and 2 feet outside curbline in fills. Provide alternate layers of suitable soils or soils other than A-7 or A-5 containing 3% or more carbon</p>	<p>1. Shale 2. A-7-5 or A-5 soils having a density greater than 86 pcf but less than 95 pcf (ASTM D 698 Standard Proctor Density).</p>
<p>Type B Placement Placed 5 feet below subgrade and outside curbline in fills</p>	<p>1. A-7-6 (Plasticity index of 30 or greater) 2. Residual clays (overlying bedrock) regardless of classification.</p>
<p>Type C Placement Placed 3 feet below subgrade in fills (may be placed 2 feet outside of curbline).</p>	<p>1. All soils other than A-7-5 or A-5 having a density of 95 pcf or less (ASTM D 698 Standard Proctor Density). 2. All soils other than A-7 or A-5 containing 3% or more carbon.</p>
<p>Slope dressing only</p>	<p>1. Peat or muck 2. Soils with a plasticity index of 35 or greater 3. A-7 or A-5 (AASHTO) having a density less than 85 pcf (ASTM D 698 Standard Proctor Density)</p>

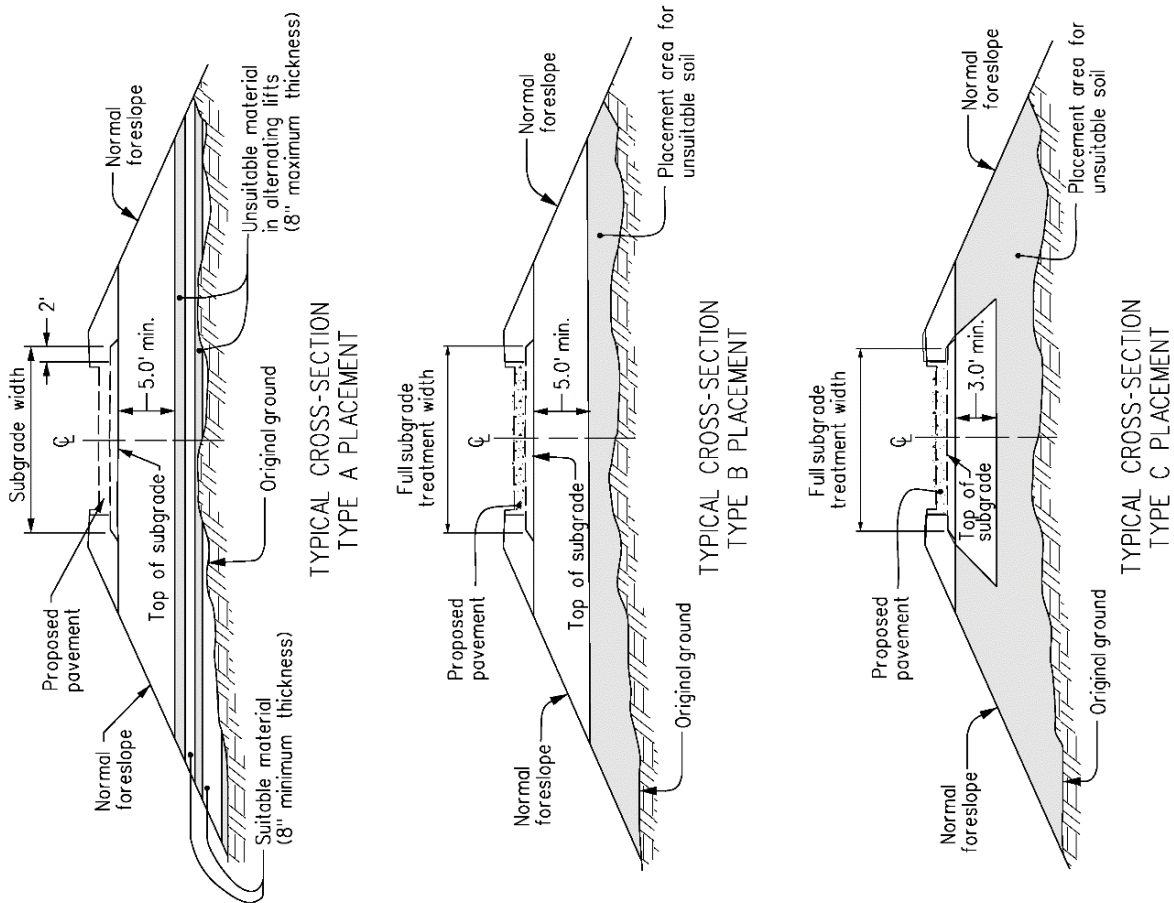

Source: Modified version of [Iowa DOT's Standard Road Plan EW-102](#).

H. Testing

Inherent to the quality construction of roadway embankments is the ability to measure soil properties to enforce quality control measures. In the past, density and moisture content have been the most widely measured soil parameters in conjunction with acceptance criteria.

1. **In-place Soil Density Requirements:** The Engineer must first establish the standard to which the field work must conform. This standard differs depending upon whether the soil is classified as coarse-grained, fine-grained, or inter-grade (Duncan 1992).
 - a. **In-place Soil Density:** The SUDAS Specifications require 95% Standard Proctor Density for cohesive soils and 70% Relative Density for cohesionless soils. If different density requirements are warranted for a project, the Engineer must specify those modifications. As the default, SUDAS Specifications require moisture and density control for embankment construction. In lieu of moisture and density control, the Engineer may specify Type A compaction, which is roller walkout and does not require moisture and density testing.
 - b. **Tests to Verify In-place Soil Density:** For these classifications of soil, the dry density of the in-place, compacted soil must be determined. There are three procedures whereby the wet density of the in-place soil can be readily determined in the field. Once the in-place wet density and the moisture content are known, the dry density can be easily computed. These procedures are described in the following ASTM Standards:
 - 1) **Density of Soil in Place by the Sand-cone Method (ASTM D 1556):** This method is generally limited to soil in an unsaturated condition. It is not recommended for soil that is soft or easily crumbled or for deposits where water will seep into the test hole.
 - 2) **Density and Unit Weight of Soil in Place by the Rubber Balloon Method (ASTM D 2167):** This method is not suitable for use with organic, saturated, or highly plastic soils. The use of this method will require special care with unbonded granular soils, soils containing appreciable amounts of coarse aggregate larger than 1½ inches, granular soils having a high void ratio, and fill materials having particles with sharp edges.
 - 3) **Density of Soil and Soil Aggregate in Place by Nuclear Methods (ASTM D 2922):** This method provides a rapid, non-destructive technique for the determination of in-place wet soil density. Test results may be affected by chemical composition, heterogeneity, and surface texture of the material being tested. The techniques also exhibit a spatial bias in that the apparatus is more sensitive to certain regions of the material being tested. Nuclear methods, of course, pose special hazards and require special care. The work must be done in strict conformance with all safety requirements and must be performed only by trained personnel.
2. **Field Control of Moisture Content:** [SUDAS Specifications Section 2010](#) requires a moisture content of optimum moisture to 4% over optimum moisture. As discussed earlier, the moisture content may need to be modified, depending on the material type and desired characteristics. There are four general procedures whereby moisture content can be determined:
 - a. Accurate results can be achieved by the laboratory analysis of samples using a drying oven according to AASHTO T 265. This method, however, may be too time consuming.
 - b. Fast results can be obtained in the field with a portable moisture tester. This particular tester, which conforms to AASHTO T 217, provides for almost continuous monitoring of the moisture content because the test can usually be performed in three minutes or less.
 - c. A microwave may be used for fine-grained soils, according to ASTM D 600.

- d. A nuclear density unit may be used to provide an estimate of the moisture content, according to AASHTO T 239.

It is important that the moisture content of the soil be maintained as close to the target moisture content as can reasonably be expected during all stages of the compaction process. When the soil is too dry, the moisture content can be increased by sprinkling water over the surface, after which it must be thoroughly mixed into the soil to produce uniform moisture content throughout the mass. When the soil is too wet, the moisture content can be reduced by spreading the soil out, disking it, and letting it dry in the sun.

3. **Strength and Stability of Compacted Soil:** Two methods are used to determine the strength and stability of compacted soil.
- a. **California Bearing Ratio (CBR):** This method is probably the most widely used. A subgrade generally requiring a CBR of 10 or greater is considered good and can support heavy loading without excessive deformation (see [Section 6E-1 - Subgrade Design and Construction](#), for additional information). For reference, some typical values of CBR soils are shown in Table 6D-1.03.
- b. **Dynamic Cone Penetrometer (DCP) Index:** This index, expressed in millimeters per blow, has been correlated to CBR for use in pavement design and evaluation, and is presented in ASTM Section B, Test Method No. 8. The correlation is advantageous because most flexible pavement design procedures are based on CBR. Several other DCP versus CBR relationships have been developed as well.

Table 6D-1.03: Typical CBR Values for Various Soils

Material Description	CBR
SC: clayey sand	10-20
CL: lean clays, sandy clays, gravelly clays	5-15
ML: silts, sandy silts	5-15
OL: organic silts, lean organic clays	4-8
CH: fat clays	3-5
MH: plastic silts	4-8
OH: fat organic clays	3-5

Source: Rollings and Rollings, 1996

Table 6D-1.04: Simple CBR Indicators of Wet Clay Soil

Material Description	CBR
Thumb penetration into the wet clay soil	
Easy	< 1
Possible	1
Difficult	2
Impossible	3+
A trace of a footprint left by a walking man	1

I. References

Abramson, L., T. Lee, S. Sharma, and G. Boyce. *Slope Stability and Stabilization Methods*. New York: John Wiley & Sons, Inc. 2002.

Ariema, F. and B. Butler. Chapter 6 in *Guide to Earthwork Construction*. State of the Art Report 8, Transportation Research Board National Research Council. 1990.

Atkins, H.N. *Highway Materials, Soils, and Concretes*. Third Edition. Prentice Hall. 1997.

Chatwin, S., D. Howes, J. Schwab, and D. Swanston. *A Guide for Management of Landslide-Prone Terrain in the Pacific Northwest*. Victoria, BC: Land Management Handbook No. 18, Ministry of Forests. 1994.

Das, B.M. *Principles of Geotechnical Engineering*. Pacific Grove: Brooks Cole. 2002.

Duncan, C.I. *Soils and Foundations for Architects and Engineers*. New York: Van Nostrand Reinhold. 1992.

Hilf, J.W. *Foundation Engineering Handbook*. Second Edition. New York: Van Nostrand Reinhold. 1956.

Rollings, M.P. and R.S. Rollings. *Geotechnical Materials in Construction*. New York: McGraw-Hill. 1996.

Spiker, E., and P. Gori. *National landslide hazards mitigation strategy – a framework for loss reduction*. U.S. Geological Survey, Circular 1244: 4-13. 2003.

Additional Resources:

Bergeson, K., C. Jahren, and D. White. *Embankment Quality Phase I Report*. Iowa: Report No. TR-401, Iowa Department of Transportation. 1998.

Drumm, E.C., et al. *Incorporation of Environmental Factors in Flexible Pavement Design*. Knoxville, TN: Department of Civil and Environmental Engineering, the University of Tennessee. 1998.

Dunlop, R. J. *New Zealand Supplement to the Document, Pavement Design-A Guide to the Structural Design of Road Pavements*. Wellington, NZ: Transit New Zealand. 2000.

Humboldt Manufacturing. *Voluvessel*. Norridge: Humboldt Materials Testing Solutions. 2007.

Humboldt Manufacturing. *Soil Moisture Oven*. Norridge: Humboldt Materials Testing Solutions. 2007.

Maryland Department of the Environment. *Environmental Agency, Police Seek Missing Nuclear Gauge*. Baltimore, MD: Maryland Department of the Environment. 2004.

Skok, E.L., E.N. Johnson, and M. Brown. *Special Practices for Design and Construction of Subgrades in Poor, Wet and/or Saturated Soil Condition*. Minnesota: Report No. MN/RC-2003-36, Minnesota Department of Transportation. 2003.

White, D., K. Bergeson, and C. Jhren. *Embankment Quality: Phase II*. Iowa: Report No. TR-401, Iowa Department of Transportation. 2000.

White, D., K. Bergeson, and C. Jhren. *Embankment Quality: Phase III*. Iowa: Report No. TR-401, Iowa Department of Transportation. 2002.

Subgrade Design and Construction

A. General Information

The subgrade is that portion of the pavement system that is the layer of natural soil upon which the pavement or subbase is built. Subgrade soil provides support to the remainder of the pavement system. The quality of the subgrade will greatly influence the pavement design and the actual useful life of the pavement that is constructed. The importance of a good quality subgrade to the long term life of the pavement cannot be understated. As the pavement reaches design life, the subgrade will not have to be reconstructed in order to support the rehabilitated subgrade or the reconstructed pavement. In urban areas, subgrade basic engineering properties are required for design. This section summarizes the design and construction elements for subgrades.

B. Site Preparation

Site preparation is the first major activity in constructing pavements. This activity includes removing or stripping off the upper soil layer(s) from the natural ground. All organic materials, topsoil, and stones greater than 3 inches in size should be removed. Removal of surface soils containing organic matter is important not only for settlement, but also because these soils are often moisture-sensitive, they lose significant strength when wet and are easily disturbed under construction activities. Most construction projects will also require excavation or removal of in-situ soil to reach a design elevation or grade line.

C. Design Considerations

Subgrade soil is part of the pavement support system. Subgrade performance generally depends on three basic characteristics:

- 1. Strength:** The subgrade must be able to support loads transmitted from the pavement structure. This load-bearing capacity is often affected by degree of compaction, moisture content, and soil type. A subgrade having a California Bearing Ratio (CBR) of 10 or greater is considered essential and can support heavy loads and repetitious loading without excessive deformation.
- 2. Moisture Content:** Moisture tends to affect a number of subgrade properties, including load-bearing capacity, shrinkage, and swelling. Moisture content can be influenced by a number of factors, such as drainage, groundwater table elevation, infiltration, or pavement porosity (which can be affected by cracks in the pavement). Generally, excessively wet subgrades will deform under load.
- 3. Shrinkage and/or Swelling:** Some soils shrink or swell, depending upon their moisture content. Additionally, soils with excessive fines content may be susceptible to frost heave in northern climates. Shrinkage, swelling, and frost heave will tend to deform and crack any pavement type constructed over them.

Pavement performance also depends on subgrade uniformity. However, a perfect subgrade is difficult to achieve due to the inherent variability of the soil and influence of water, temperature, and construction activities. Emphasis should be placed on developing a subgrade CBR of at least 10. Research has shown that with a subgrade strength of less than a CBR of 10, the subbase material will deflect under traffic loadings in the same manner as the subgrade. That deflection then impacts the pavement, initially for flexible pavements, but ultimately rigid pavements as well.

To achieve high-quality subgrade, proper understanding of soil properties, proper grading practices, and quality control testing are required. However, pavement design requirements and the level of engineering effort should be consistent with relative importance, size, and cost of design projects. Therefore, knowledge of subgrade soil basic engineering properties is required for design. These include soil classification, soil unit weight, coefficient of lateral earth pressure, and estimated CBR or resilient modulus. Table 6E-1.01 summarizes the suitability of different soils for subgrade applications, and Table 6E-1.02 gives typical CBR values of different soils depending on soil classification.

Table 6E-1.01: Suitability of Soils for Subgrade Applications

Subgrade Soils for Design	Unified Soil Classifications	Load Support and Drainage Characteristics	Modulus of Subgrade Reaction (k), psi/inch	Resilient Modulus (M _R), psi	CBR Range
Crushed Stone	GW, GP, and GU	Excellent support and drainage characteristics with no frost potential	220 to 250	Greater than 5,700	30 to 80
Gravel	GW, GP, and GU	Excellent support and drainage characteristics with very slight frost potential	200 to 220	4,500 to 5,700	30 to 80
Silty gravel	GW-GM, GP-GM, and GM	Good support and fair drainage, characteristics with moderate frost potential	150 to 200	4,000 to 5,700	20 to 60
Sand	SW, SP, GP-GM, and GM	Good support and excellent drainage characteristics with very slight frost potential	150 to 200	4,000 to 5,700	10 to 40
Silty sand	SM, non-plastic (NP), and >35% silt (minus #200)	Poor support and poor drainage with very high frost potential	100 to 150	2,700 to 4,000	5 to 30
Silty sand	SM, Plasticity Index (PI) <10, and <35 % silt	Poor support and fair to poor drainage with moderate to high frost potential	100 to 150	2,700 to 4,000	5 to 20
Silt	ML, >50% silt, liquid limit <40, and PI <10	Poor support and impervious drainage with very high frost value	50 to 100	1,000 to 2,700	1 to 15
Clay	CL, liquid limit >40 and PI >10	Very poor support and impervious drainage with high frost potential	50 to 100	1,000 to 2,700	1 to 15

Source: American Concrete Pavement Association; Asphalt Paving Association; State of Ohio; State of Iowa; Rollings and Rollings 1996.

D. Strength and Stiffness

Subgrade materials are typically characterized by their strength and stiffness. Three basic subgrade stiffness/strength characterizations are commonly used in the United States: California Bearing Ratio (CBR), modulus of subgrade reaction (k), and elastic (resilient) modulus. Although there are other factors involved when evaluating subgrade materials (such as swell in the case of certain clays), stiffness is the most common characterization and thus CBR, k-value, and resilient modulus are discussed here.

1. **California Bearing Ratio (CBR):** The CBR test is a simple strength test that compares the bearing capacity of a material with that of a well-graded crushed stone (thus, a high-quality crushed stone material should have a CBR of 100%). It is primarily intended for, but not limited to, evaluating the strength of cohesive materials having maximum particle sizes less than 0.75 inches. Figure 6E-1.01 is an image of a typical CBR sample.

Figure 6E-1.01: In-situ CBR



Source: ELE International

The CBR method is probably the most widely used method for designing pavement structures. This method was developed by the California Division of Highways around 1930 and has since been adopted and modified by numerous states, the U.S. Army Corps of Engineers (USACE), and many countries around the world. Their test procedure was most generally used until 1961, when the American Society for Testing and Materials (ASTM) adopted the method as ASTM D 1883, CBR of Laboratory-Compacted Soils. The ASTM procedure differs in some respects from the USACE procedure and from AASHTO T 193. The ASTM procedure is the easiest to use and is the version described in this section.

The CBR is a comparative measure of the shearing resistance of soil. The test consists of measuring the load required to cause a piston of standard size to penetrate a soil specimen at a specified rate. This load is divided by the load required to force the piston to the same depth in a standard sample of crushed stone. The result, multiplied by 100, is the value of the CBR. Usually, depths of 0.1 to 0.2 inches are used, but depths of 0.3, 0.4, and 0.5 inches may be used if desired. Penetration loads for the crushed stone have been standardized. This test method is intended to provide the relative bearing value, or CBR, of subbase and subgrade materials. Procedures are given for laboratory-compacted swelling, non-swelling, and granular materials. These tests are usually performed to obtain information that will be used for design purposes. The CBR value for a soil will depend upon its density, molding moisture content, and moisture content after soaking. Since the product of laboratory compaction should closely represent the

results of field compaction, the first two of these variables must be carefully controlled during the preparation of laboratory samples for testing. Unless it can be ascertained that the soil being tested will not accumulate moisture and be affected by it in the field after construction, the CBR tests should be performed on soaked samples.

Relative ratings of supporting strengths as a function of CBR values are given in Table 6E-1.02.

Table 6E-1.02: Relative CBR Values for Subbase and Subgrade Soils

CBR (%)	Material	Rating
> 80	Subbase	Excellent
50 to 80	Subbase	Very Good
30 to 50	Subbase	Good
20 to 30	Subgrade	Very good
10 to 20	Subgrade	Fair-good
5 to 10	Subgrade	Poor-fair
< 5	Subgrade	Very poor

The higher the CBR value of a particular soil, the more strength it has to support the pavement. This means that a thinner pavement structure could be used on a soil with a higher CBR value than on a soil with a low CBR value. Generally, clays have a CBR value of 6 or less. Silty and sandy soils are next, with CBR values of 6 to 8. The best soils for road-building purposes are the sands and gravels whose CBR values normally exceed 10. Most Iowa soils rate fair-to-poor as subgrade materials.

The change in pavement thickness needed to carry a given traffic load is not directly proportional to the change in CBR value of the subgrade soil. For example, a one-unit change in CBR from 5 to 4 requires a greater increase in pavement thickness than does a one-unit change in CBR from 10 to 9.

- 2. Resilient Modulus (M_R):** M_R is a subgrade material stiffness test. A material's M_R is actually an estimate of its modulus of elasticity (E). While the modulus of elasticity is stress divided by strain for a slowly applied load, M_R is stress-divided by strain for rapidly applied loads like those experienced by pavements. Flexible pavement thickness design is normally based on M_R . See Table 6E-1.01 for typical M_R values.

The resilient modulus test applies a repeated axial cyclic stress of fixed magnitude, load duration, and cycle duration to a cylindrical test specimen. While the specimen is subjected to this dynamic cyclic stress, it is also subjected to a static confining stress provided by a triaxial pressure chamber. It is essentially a cyclic version of a triaxial compression test; the cyclic load application is thought to more accurately simulate actual traffic loading.

The M_R is a slightly different measurement of somewhat similar properties of the soil or subbase. It measures the amount of recoverable deformation at any stress level for a dynamically loaded test specimen. Both measurements are indications of the stiffness of the layer immediately under the pavement.

The environment can affect pavement performance in several ways. Temperature and moisture changes can have an effect on the strength, durability, and load-carrying of the pavement and roadbed materials. Another major environmental impact is the direct effect roadbed swelling, pavement blowups, frost heave, disintegration, etc. can have on loss of riding quality and serviceability. If any of these environmental effects have a significant loss in serviceability or

ride quality during the analysis period, the roadbed soil M_R takes the environmental effects into account if seasonal conditions are considered.

The purpose of using seasonal modulus is to qualify the relative damage a pavement is subject to during each season of the year and treat it as part of the overall design. An effective road bed soil modulus is then established for the entire year which is equivalent to the combined effects of all monthly seasonal modulus values. AASHTO provides different methodology to obtain the effective M_R for flexible pavement only. The method that was selected for use in this manual was based on the determination of M_R values for six different climatic regions in the United States that considered the quality of subgrade soils.

Figure 6E-1.03: Resilient Modulus



Source: Federal Highway Administration

3. **Modulus of Subgrade Reaction (k , k_c):** This is a bearing test that rates the support provided by the subgrade or combination of subgrade and subbase. The k -value is defined as the reaction of the subgrade per unit of area of deformation and is typically given in psi/inch. Concrete pavement thickness design is normally based on the k -value. See Table 6E-1.01 for typical k -values.

Modulus of subgrade reaction is determined with a plate bearing test. Details for plate bearing tests are found in AASHTO T 221 and AASHTO T 222 or ASTM D 1195 and ASTM D 1196.

Several variables are important in describing the foundation upon which the pavement rests:

- a. **Modulus of Subgrade Reaction (k):** For concrete pavements, the primary requirement of the subgrade is that it be uniform. This is the fundamental reason for specifications on subgrade compaction. The k -value is used for thickness design of concrete pavements being placed on prepared subgrade.
- b. **Composite Modulus of Subgrade Reaction (k_c):** In many highway applications the pavement is not placed directly on the subgrade. Instead, some type of subbase material is used. When this is done, the k value actually used for design is a "composite k " (k_c), which represents the strength of the subgrade corrected for the additional support provided by the subbase.

4. Correlation of Strength and Stiffness Values:

- a. Relationship of CBR and Dynamic Cone Penetrometer (DCP) Index:** The dual mass Dynamic cone Penetrometer (DCP) is a method for estimating in-place stability from CBR correlations. As shown in Figure 6E-1.05, the dual mass DCP consists of an upper and lower 5/8 inch diameter steel shaft with a steel cone attached to one end. The cone at the end of the rod has a base diameter of 0.79 plus 0.01 inches. As an option, a disposable cone attachment can be used for testing of soils where the standard cone is difficult to remove from the soil. According to Webster et al. (1992), the disposable cone allows the operator to perform twice the number of tests per day than with the standard cone. At the midpoint of the upper and lower rods, an anvil is located for use with the dual mass sliding hammers. By dropping either a 10.1 or a 17.6 pound hammer 22.6 inches and impacting the anvil, the DCP is driven into the ground. For comparison, the penetration depth caused by one blow of the 17.6 pound sliding hammer would be approximately equivalent to two blows from the 10.1 pound hammer. The 10.1 pound hammer is more suitable for sensitive clayey soils with CBR values ranging from 1 to approximately 10; however, it is capable of estimating CBR values up to 80. In general, the 17.6 pound hammer is rated at accurately measuring CBR values from 1 to 100. At its full capacity, the DCP is designed to penetrate soils up to 39 inches. In highly plastic clay soils, the accuracy of the DCP index decreases with depth due to soil sticking to the lower rod. If necessary, hand-augering a 2 inch diameter hole can be used to open the test hole in 12 inch increments, preventing side friction interference.

CBR and DCP index (PI):

- 1) For all soils except CL below CBR of 10, and CH soils:

$$CBR = \left(\frac{292}{PI} \right)^{1.12}$$

- 2) For soils with CBR less than 10:

$$CBR = \left(\frac{1}{0.0170019 \times PI} \right)^2$$

- 3) For CH soils:

$$CBR = \left(\frac{1}{0.002871 \times PI} \right)$$

Where PI = Penetration index from DCP, (mm/blow)

Figure 6E-1.05: DCP Design and Cone Tip Details

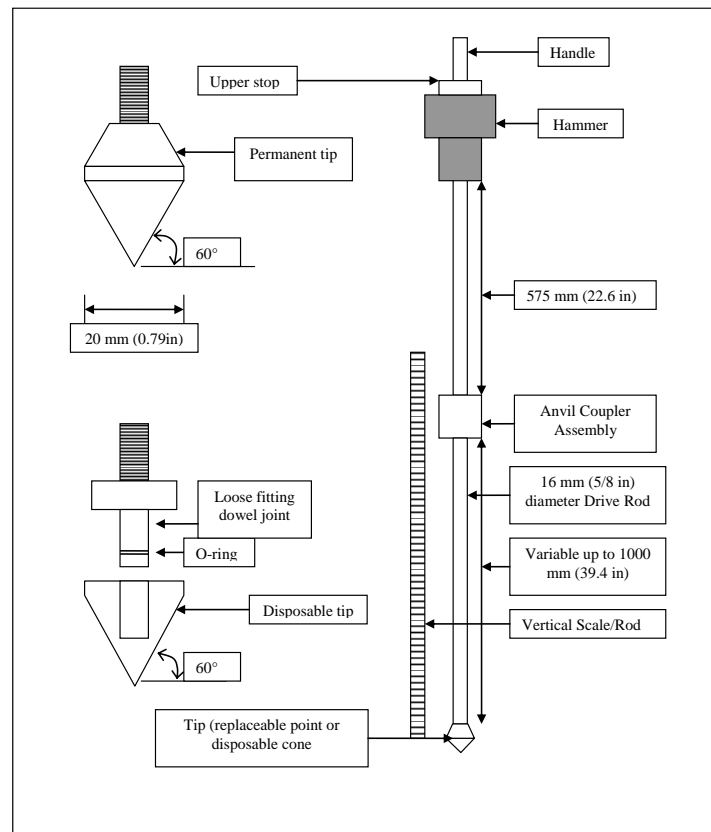

- b. **Relationship of M_R and k-value:** An approximate relationship between k and M_R published by AASHTO is fairly straightforward.

$$k = M_R/19.4$$

where

k = modulus of subgrade reaction (psi/inch)

M_R = roadbed soil resilient modulus of the soil as determined by AASHTO T 274.

- c. **Relationship of CBR, M_R , and k-value:** See approximate relationships in Table 6E-1.01.

E. Subgrade Construction

- General:** The most critical element for subgrade construction is to develop a CBR of at least 10 in the prepared subgrade using on-site, borrow, or modified soil (see [Section 6H-1 - Foundation Improvement and Stabilization](#)). Uniformity is important, especially for rigid pavements, but the high level of subgrade support will allow the pavement to reach the design life.

In most instances, once heavy earthwork and fine grading are completed, the uppermost zone of subgrade soil (roadbed) is improved. The typical improvement technique is achieved by means of mechanical stabilization (i.e., compaction). Perhaps the most common problem arising from deficient construction is related to mechanical stabilization. Without proper quality control and quality assurance (QC/QA) measures, some deficient work may go unnoticed. This is most common in utility trenches and bridge abutments, where it is difficult to compact because of

vertical constraints. This type of problem can be avoided, or at least minimized, with a thorough plan and execution of the plan as it relates to QC/QA during construction. This plan should pay particular attention to proper moisture content, proper lift thickness for compaction, and sufficient configuration of the compaction equipment utilized (weight and width are the most critical). Failure to adequately construct and backfill trench lines will most likely result in localized settlement and cracking at the pavement surface.

2. **Compaction:** Compaction of subgrade soils is a basic subgrade detail and is one of the most fundamental geotechnical operations for any pavement project. The purpose of compaction is generally to enhance the strength or load-carrying capacity of the soil, while minimizing long-term settlement potential. Compaction also increases stiffness and strength, and reduces swelling potential for expansive soils.

- a. **Density/Moisture:** The most common measure of compaction is density. Soil density and optimum moisture content should be determined according to ASTM D 698 (Standard Proctor Density) or ASTM D 4253 and D 4254 (Maximum and Minimum Index Density for Cohesionless Soils). At least one analysis for each material type to be used as backfill should be conducted unless the analysis is provided by the Engineer.

Field density is correlated to moisture-density relationships measured in the lab. Moisture-density relationships for various soils are discussed in Part 6A - General Information. Optimal engineering properties for a given soil type occur near its compaction optimum moisture content, as determined by the laboratory tests. At this state, a soils-void ratio and potential to shrink (if dried) or swell (if inundated with water) is minimized.

For pavement construction, cohesive subgrade soil density should satisfy 95% of Standard Proctor tests, with the moisture content not less than optimum and not greater than 4% above optimum. For cohesionless soils (sands and gravel), a minimum relative density of 65% should be achieved with the moisture content greater than the bulking moisture content.

- b. **Strength/Stiffness:** Inherent to the construction of roadway embankments is the ability to measure soil properties to enforce quality control measures. In the past, density and moisture content have been the most widely measured soil parameters in conjunction with acceptance criteria. However, it has been shown recently that density and moisture content may not be an adequate analysis. Therefore, alternate methods of in-situ testing have been reviewed. The dual mass Dynamic Cone Penetrometer (DCP) is a method for estimating in-place stability from CBR correlations.
- c. **Equipment:** Several compaction devices are available in modern earthwork, and selection of the proper equipment is dependent on the material intended to be densified. Generally, compaction can be accomplished using pressure, vibration, and/or kneading action. Different types of field compaction equipment are appropriate for different types of soils. Steel-wheel rollers, the earliest type of compaction equipment, are suitable for cohesionless soils. Vibratory steel rollers have largely replaced static steel-wheel rollers because of their higher efficiency. Sheepsfoot rollers, which impart more of a kneading compaction effort than smooth steel wheels, are most appropriate for plastic cohesive soils. Vibratory versions of sheepsfoot rollers are also available. Pneumatic rubber-tired rollers work well for both cohesionless and cohesive soils. A variety of small equipment for hand compaction in confined areas is also available. Table 6E-1.03 summarizes recommended field compaction equipment for various soil types.

Table 6E-1.03: Recommended Field Compaction Equipment

Soil	First Choice	Second Choice	Comment
Rock fill	Vibratory	Pneumatic	--
Plastic soils, CH, MH	Sheepsfoot or pad foot	Pneumatic	Thin lifts usually needed
Low-plasticity soils, CL, ML	Sheepsfoot or pad foot	Pneumatic, vibratory	Moisture control often critical for silty soils
Plastic sands and gravels, GC, SC	Vibratory, pneumatic	Pad foot	--
Silty sands and gravels, SM, GM	Vibratory	Pneumatic, pad foot	Moisture control often critical
Clean sands, SW, SP	Vibratory	Impact, pneumatic	--
Clean gravels, GW, GP	Vibratory	Pneumatic, impact, grid	Grid useful for over-size particles

Source: Rollings and Rollings 1996

The effective depth of compaction of all field equipment is usually limited, so compaction of thick layers must be done in a series of lifts, with each lift thickness typically in the range of 6 to 8 inches.

The soil type, degree of compaction required, field compaction energy (type and size of compaction equipment and number of passes), and the contractor's skill in handling the material are key factors determining the maximum lift thickness that can be compacted effectively. Control of water content in each lift, either through drying or addition of water plus mixing, may be required to achieve specified compacted densities and/or to meet specifications for compaction water content.

Proof-rolling with heavy rubber-tired rollers is used to identify any remaining soft areas. The proof-roller must be sized to avoid causing bearing-capacity failures in the materials that are being proof-rolled. Proof-rolling is not a replacement for good compaction procedures and inspection. An inspector needs to be present onsite to watch the deflections under the roller in order to identify soft areas. Construction equipment such as loaded scrapers and material delivery trucks can also be used to help detect soft spots along the roadway alignment. It is very difficult to achieve satisfactory compaction if the lift is not on a firm foundation.

- 3. Overexcavation/Fill:** The installation of structural features (e.g., sewer, water, and other utilities) adjacent to or beneath pavements can lead to problems during or following construction. Proper installation of such utilities and close inspection during construction are critical.

A key element in the installation of these systems is proper compaction around and above the pipe. Granular fill should always be used to form a haunch below the pipe for support. Some agencies are using flowable fill or controlled low strength material (CLSM) as an alternative to compacted granular fill. Without this support feature, the weight above the pipe may cause it to deform, creating settlement above the pipe, and often pipe collapse. Even if a sinkhole does not appear, leaks of any water-bearing utility will inundate the adjacent pavement layers, reducing their support capacity.

Pavement problems also occur when improper fill is used in the embankment beneath the pavement system. Placement of tree trunks, large branches, and wood pieces in embankment fill must not be allowed. Over time, these organic materials decay, causing localized settlement, and

they eventually form voids in the soil. Again, water entering these voids can lead to collapse and substantial subsidence of the pavement section. Likewise, placement of large stones and boulders in fills create voids in the mass, either unfilled due to bridging of soil over the large particles or filled with finer material that cannot be compacted with conventional equipment. Soil above these materials can migrate into the void space, creating substantial subsidence in the pavement section. These issues can be mitigated with well-crafted specifications that will prohibit the use of these types of materials.

Transitions between cut zones and fill zones can also create problems, particularly related to insufficient removal of weak organic material (clearing and grubbing), as well as neglect of subsurface water movements. A specific transition also occurs at bridge approaches. These problems are typically related to inadequate compaction, usually a result of improper compaction equipment mobilized to the site or lack of supervision and care (e.g., lift placement greater than compaction equipment can properly densify).

F. References

ELE International. *In-situ CBR*. 2007.

Federal Highway Administration. *Resilient Modulus*. 2007.

Karamihas, S.M., and T.D. Gillespie. *Assessment of Profiler Performance for Construction Quality Control: Phase I*. Michigan: Transportation Research Institute, University of Michigan. 2002.

Rollings, M.P. and R.S. Rollings. *Geotechnical Materials in Construction*. New York: McGraw-Hill. 1996.

Webster, S.L., R.H. Grau, and T.P. Williams. *Description and Application of Dual Mass Dynamic Cone Penetrometer*. Vicksburg, Mississippi: Report No. GL-92-3, Department of Army, Waterways Experiment Station. 1992.

Additional Resources:

Ping, W.V., M. Leonard, and Z. Yang. *Laboratory Simulation of Field Compaction Characteristics Phase I*. Florida: Report No. FL/DOT/RMC/BB890(F), Florida Department of Transportation. 2003.

Washington DOT. *WSDOT Pavement Guide Interactive*. Washington: Washington State Department of Transportation. 2007.

Pavement Subbase Design and Construction

A. General Information

Pavement systems generally consist of three layers: prepared subgrade, subbase, and pavement. This section will deal with the proper design and construction of subbases. The subbase is the layer of aggregate material that lies immediately below the pavement and usually consists of crushed aggregate or gravel or recycled materials (see [Section 6C-1 - Pavement Systems](#) for more information). Although the terms “base” and “subbase” are sometimes used interchangeably to refer to the subsurface layers of a pavement, base course is typically used in asphalt pavements, primarily as a structural load-distributing layer, whereas the subbase layer used in concrete pavements primarily serves as a drainage layer. Aggregate subbase is typically composed of crushed rock, comprised of material capable of passing through a 1 1/2 inch screen, with component particles varying in size from 1 1/2 inch down to dust. The material can be made of virgin (newly mined) rock or of recycled asphalt and concrete.

The function of the pavement subbase is to provide drainage and stability to achieve longer service life of the pavement. Most pavement structures now incorporate subsurface layers, part of whose function is to drain away excess water that can be deleterious to the life of the pavement (see [Section 6G-1 - Subsurface Drainage Systems](#)). However, aggregate materials for permeable bases must be carefully selected and properly constructed to provide not only permeability, but uniform stability as well. Proper construction and QC/QA testing operations can help to ensure good performance of the subbase layer. Excessive compaction can alter the gradation and create additional fines that may result in lower permeabilities than determined in laboratory tests and used in the pavement system design. However, the optimization of structural contributions from high stability, versus the need to provide adequate drainage for pavement materials is still a point of debate. The focus of this section is to provide guidance on selection of proper subbase materials, best construction practices, and suitable QC/QA testing methods.

B. Granular Subbases

- 1. Purpose:** Subbases serve a variety of purposes, including reducing the stress applied to the subgrade and providing drainage for the pavement structure. The granular subbase acts as a load-bearing layer, and strengthens the pavement structure directly below the pavement surface, providing drainage for the pavement structure on the lowest layer of the pavement system. However, it is critical to note that the subbase layer will not compensate for a weak subgrade. Subgrades with a CBR of at least 10 should provide adequate support for the subbase.
- 2. Materials:** As the granular subbase provides both bearing strength and drainage for the pavement structure, proper size, grading, shape, and durability are important attributes to the overall performance of the pavement structure. Granular subbase aggregates consist of durable particles of crushed stone or gravel capable of withstanding the effects of handling, spreading, and compacting without generation of deleterious fines.

3. **Gradation:** Aggregates used as subbase tend to be dense-graded with a nominal maximum size, commonly up to 1 1/2 inches. The percentage of fines (passing No. 200 sieve) in the subbase is limited to 10% for drainage and frost-susceptibility purposes. The Engineer may authorize a change in the gradation at the time of construction based on materials available.
 - a. **Particle Shape:** Equi-dimensional aggregate with rough surface texture is preferred.
 - b. **Permeability:** The fines content is usually limited to a maximum of 10% for normal pavement construction and 6% where free-draining subbase is required.
 - c. **Plasticity:** Plastic fines can significantly reduce the load carrying capacity of subbase; plasticity index (PI) of the fines of 6 or less is required.
4. **Construction:** Granular subbases are typically constructed by spreading the materials in thin layers compacting each layer by rolling over it with heavy compaction equipment to achieve a density greater or equal to 70% relative density.
5. **Thickness Requirement:** Typically, the thickness of the subbase is 6 inches with a minimum of 4 inches. Additional thickness beyond 6 inches could allow consolidation of the subbase over time as traffic loads accumulate. Pavement problems may result from this consolidation.

C. Recycled Materials

Recycled materials with the required particle distribution, high stiffness, low susceptibility to frost action, high permeability, and high resistance to permanent deformation can be successful subbases. Recycled aggregate can solve disposal problems, conserve energy, and lower the cost of road construction.

1. **Recycled Concrete Aggregate:** To reduce the use of natural aggregate and help preserve the environment, recycled concrete aggregate can be used. Consider the following precautions:
 - The breakage of particles results in faces, which can react with water and produce high pH. This may result in poor freeze-thaw performance.
 - The breakage of particles due to compaction and traffic loading will increase the fines percentage. This increasing fine percentage will reduce freeze-thaw resistance and permeability of bases.
 - Increased pH due to cement hydration can cause corrosion of aluminum and steel pipes.
2. **Recycled Asphalt Pavement:** Consider the following precautions.
 - 20% to 50% RAP is typically used. High percentages of RAP are not used in normal construction.
 - The stiffness increases with higher percentage of RAP, while there must be limits on percentage of RAP to incorporate into virgin material.

D. Effects of Stability and Permeability on Pavement Foundation

The subbase is the layer of aggregate material that lies immediately below the pavement and usually consists of crushed aggregate or recycled materials.

1. **The Main Roles of the Subbase Layer in Pavements:** Include provision of the following (Dawson 1995).
 - Protection for the subgrade from significant deformation due to traffic loading
 - Adequate support for the surface layer
 - Stable construction platform during pavement surfacing
 - Adequate drainage for the infiltration of rain water through cracks and joints, particularly in PCC pavements (see [Section 6G-1 - Subsurface Drainage Systems](#))
 - Subgrade protection against frost and environmental damage

2. **Effect of Undrained Water on Pavement Foundation:** Undrained water in the pavement supporting layers is a major contributor to distress and premature failure in pavements. Some of the detrimental effects of water, when entrapped in the pavements structure are that (Yang 2004):
 - Water reduces the strength of unbounded granular materials and subgrade soils.
 - Water causes pumping of concrete pavements with subsequent faulting, cracking, and general shoulder deterioration.
 - With the high hydrodynamic pressure generated by moving traffic, pumping of fines in the base course of flexible pavements may also occur with resulting loss of support.
 - In northern climates with a depth of frost penetration greater than the pavement thickness, high water table causes frost heave and the reduction of load-carrying capacity during the frost melting period.
 - Water causes differential heaving over swelling soils.
 - Continuous contact with water causes stripping of asphalt mixture and durability or “D” cracking of concrete.

Accumulated water in the subbase is a key contributing factor to subbase instability and pavement distress. Thus it is important to understand how water becomes trapped in the subbase layer. A number of other factors also affect the engineering behavior of aggregates, including fines content; aggregate type, grading, size, and shape; density; stress history; and mean stress level. Table 6F-1.01 summarizes the relative effects of these factors. From this table, it can be seen that:

- Aggregate stiffness is increased by an increase in most of the controlling factors, with the exception of fines content and moisture content, which decrease the stiffness.
- An increase in susceptibility to permanent deformation can be caused by increasing fines content and moisture content, while most other factors decrease the susceptibility.
- Strength is generally increased with an increase in density; good grading; and aggregate angularity, size, and stress level.
- Fines content has a major effect on permeability, with increased fines leading to a decrease in permeability. A well-graded aggregate is also much less permeable than a uniform gradation.
- Increased fines content decreases durability, while the changes caused by most of the other factors are minor in comparison.

Table 6F-1.01: Effects of Intrinsic and Manufactured Properties of Aggregates as Controlling Factors on Engineering Properties of Granular Material in Pavement Layers

Controlling Factor	Property				
	<i>Stiffness</i>	<i>Susceptibility to Permanent Deformation</i>	<i>Strength</i>	<i>Permeability</i>	<i>Durability</i>
Fines content	↓ ?	↑	varies	major ↓	↓
Type: gravel instead of crushed rock	↑	↑	↑	none	usually ↑
Grading: well graded instead of single-sized	minor ↑	↓	↑	major ↓	↓
Maximum size: large instead of small	↑	↓ ?	minor ↑	↑	↓ ?
Shape: angular/rough instead of rounded/smooth	↑	↓	↑	minor	minor
Density	↑	↓	↑	↓	minor
Moisture content	major ↓	major ↑	major ↓	major ↑	varies
Stress history	↑ ?	major ↓	minor ↓	none	?
Mean stress level	↑	↓	↑	minor ↓	↓

Notes:

↑ = Value of property increases with increase (or indicated change) in controlling factor

↓ = Value of property decreases with increase (or indicated change) in controlling factor

? = Effect of property variation not well established

Source: Dawson et al. 2000

E. Effect of Compaction

According to Merriam-Webster's Collegiate Dictionary Eleventh Edition (2003), compaction is defined as "the act or process of compacting; the state of being compacted; to closely unite or pack, to concentrate in a limited area or small space." It is thus a process of particles being forced together to contact one another at as many points as physically possible with the material. Density is defined as "the quality or state of being dense; the quantity per unit volume," as the weight of solids per cubic foot of material. Thus, density is simply a measure of the number of solids in a unit volume of material; density and degree of compaction differ. Two aggregate bases may have the same density but different degrees of compaction due to differences in gradation.

Also, the maximum achievable density, when calculated based on standard lab procedures at a certain level of degree of compaction, is true only when material tested in the laboratory is identical to the field material in all respects of engineering parameters, or the same compactive effort is used to achieve compaction. Therefore, differences in materials and compactive effort can significantly change the density, thereby rendering the calculated percent compaction meaningless. Laboratory compaction testing performed on subbase layers according to AASHTO T 99; Standard Proctor density shows a significant change in density and optimum water content with change in gradation in similar aggregate types. Therefore, it is recommended to use relative density values correlated to gradation for compaction control of aggregate materials in the field to avoid inadequate compaction. A relative density of at least 70% is recommended.

F. Influence of Aggregate Properties on Permeability of Pavement Bases

The drainability of a pavement subbase is measured using the coefficient of permeability, denoted as k , which defines the quantity of water that flows through a material for a given set of conditions. The quantity of flow through a given medium increases as the coefficient of permeability increases.

The coefficient of permeability is defined as “the rate of discharge of water at 20° C under conditions of laminar flow through a unit cross-sectional area of a soil medium under a unit hydraulic gradient” (Thornton and Leong 1995). Coefficient of permeability measured in pavement subbases is denoted as hydraulic conductivity, which has the same units as velocity, and is expressed in units of length per time (cm/sec or feet per day). (Note: 1 cm/s = 2835 feet per day). Various properties that influence hydraulic conductivity of a pavement subbase include: gradation and shape of aggregate, hydraulic gradient, viscosity of the permeant, porosity and void ratio of the mix, and degree of saturation (Das 1990).

- 1. Effect of Gradation and Shape of Aggregate:** According to Cedergren (1974), the life of a poorly drained pavement is reduced to one-third or even less of the life of a well drained pavement.

Miyagawa (1991) conducted both laboratory and in-situ hydraulic conductivity tests on a wide range of pavement subbases in Iowa. Laboratory test results indicate that crushed limestone has higher hydraulic conductivity with a range of 7,000 to 36,900 feet per day, compared to crushed concrete with a range of about 340 to 12,780 feet per day. A procedure was developed to obtain a relative idea of in-situ hydraulic conductivity tests. This consisted of coring out an approximately 4 inch diameter hole to a depth of 4 to 5 inches, filling the hole with 1 liter of water, and measuring the time taken to drain the water from the hole. Compared to laboratory test results, in-situ tests produce on the order of 20 to 1,000 feet per day. This reduction is believed to be a result of changes in gradation during compaction of the subbase material.

- 2. Thickness Design for Achieving Desired Drainability:** The major sources of water in pavement systems are surface infiltration, ground water seepage, and melting of ice lenses. A complete pavement drainage system is typically composed of an aggregate subbase, subdrains, and connections to storm sewage systems (see [Section 6G-1 - Subsurface Drainage Systems](#)). A positive drainage system should transport water from the point of infiltration to the final exit (transverse drains) through material having high hydraulic conductivity and should eliminate any conditions that would restrict the flow (Moulton 1980).

G. Construction Methods

Benefits of using open-graded permeable subbase layers are widely accepted throughout the world. But working with open-graded material in the field and obtaining a workable platform for the overlying surface is not yet well defined. According to White et al. (2004), significant segregation of fines is observed on subbase projects in Iowa, thus contributing to the high variation (coefficient of variation = 100%) in the measured in-place permeability. To reduce segregation, the following construction operations were recommended:

- A motor grader with a sharp angle (i.e., 45 degrees), should be used to push the aggregate transversely from a center windrow/pile, instead of spreading the aggregate material longitudinally along the pavement section (Pavement Technology Workshop 2000).
- When recycled PCC is used for granular subbases, construction traffic on the subbase should be minimized.
- A motor grader with GPS-assisted grading (i.e., stakeless grading control) should be used to prepare the final surface for paving, rather than trimming equipment.

If trimming equipment must be used, the aggregate should be delivered to the site with sufficient water content (7% to 10%) to bind the fines during trimming to prevent segregation.

The key to a properly constructed subbase is keeping the material uniformly moist and homogeneously blended. The amended subbase material may be placed and trimmed with an auto-trimmer or dumped from trucks and spread with a motorgrader. The placement and compaction should be completed to minimize segregation and with a minimal increase in fines.

H. Quality Control/Quality Assurance Testing

1. In-situ Measurement of Stability of Aggregate Subbase:

- a. **Dynamic Cone Penetrometer (DCP) Test:** DCP is an instrument designed for rapid in-situ measurement of the structural properties of existing pavements with unbound granular materials (Ese et al.1994). The cone penetration is inversely related to the strength of the material. DCP test is conducted according to ASTM D 6951 (Standard Test Method for Use of Dynamic Cone Penetrometer in Shallow Pavement Applications), which was first released in 2003. This test involves measurement of penetration rate per each blow of a standard 17.6-pound hammer, through undisturbed and/or compacted materials. Primary advantages of this test are its availability at lower costs and ease to collect and analyze the data rapidly (See [Section 6E-1 - Subgrade Design and Construction](#), for more information).
- b. **Clegg Impact Hammer Test:** This test was standardized in 1995 as ASTM D 5874, (Standard Test Method for Determination of the Impact Value IV of a Soil). This is a simple and rapid in-situ test that can be performed on subbase and subgrade materials. This test method is suitable to evaluate the strength characteristics of soils and soil aggregates having maximum particle size less than 1.5 inches (ASTM D 5874).
- c. **GeoGauge Vibration Stiffness Test:** The GeoGauge is a 22 pound electro-mechanical instrument, which provides a direct measure of in-situ stiffness (MN/m) and modulus (MPa). The test is a simple non-nuclear test on soils and granular materials that can be performed without penetrating into the ground.
- d. **Portable Falling Weight Deflectometer (PFWD) Test:** The PFWD test is a simple and rapid non-destructive test that does not entail removal of pavement materials, and hence is often preferred over other destructive methods. In addition, the testing apparatus is easily transported. Layer moduli can be back-calculated from the observed dynamic response of the subbase surface to an impulse load.
- e. **Falling Weight Deflectometer (FWD) Test:** The FWD is a trailer-mounted system that is similar to the PFWD but generally imparts a higher load pulse to simulate vehicle wheel loads. FWD tests are normally performed on the pavement surface, but, with special testing criteria, they can be performed directly on granular base layers and can be used to back-calculate layer moduli up to about 6 feet deep. FWD results are often dependent on factors such as the particular model of the test device, the specific testing procedure, and the method of back-calculation (FAA 2004).

- 2. In-situ Hydraulic Conductivity Testing:** Construction operations might significantly alter the material properties from what are tested in the laboratory. Hence, in-situ hydraulic conductivity testing provides better insights to evaluate the performance of pavement subbases. Although a variety of approaches to determine the field permeability have been documented (Moulton and Seals 1979), virtually no in-situ testing is being conducted as part of the construction practice to verify the hydraulic conductivity of granular subbase layers; yet the impact of drainage on design calculations and long-term performance is well documented. This lack of field permeability measurement provides little confidence that assumed design values are representative of the actual field conditions and does not address the fact that permeability is one of the most highly variable parameters in geotechnical engineering practice. Some of the factors that contribute to the high level of variability include inherent variations in the material gradation and morphology; segregation caused from construction activities to deposit and spread the aggregate; and particle breakdown from compaction and construction traffic (White et al. 2004).

I. References

- Cedergren, H.R. *Drainage of Highway and Airfield Pavements*. New York: John Wiley & Sons. 1974.
- Das, M.B. *Principles of Geotechnical Engineering*. Second Edition. Boston: PWS-KENT Publishing Company. 1990.
- Dawson, A.R. *The Unbound Aggregate Pavement Base*. Paper presented at the Center for Aggregates Research, 3rd Annual Symposium, Austin, Texas. 1995.
- Dawson, A.R., M.J. Mundy, and M. Huhtala. *European research into granular material for pavement bases and sub-bases*. Transportation Research Record, n 1721, 91-99. 2000.
- Ese Dag, Myre Jostein, Noss Per, Vaerness Einar. *The Use of Dynamic Cone Penetrometer (DCP) for Road Strengthening Design in Norway*. 4th International Conference on Bearing Capacity of Roads and Airfields, Vol 1, 343-357. 1994.
- Federal Aviation Agency (FAA). *Use of Nondestructive Testing in the Evaluation of Airport Pavements*. Landover, MD: Advisory Circular No. 150/5370-11A, U.S. Department of Transportation. 2004.
- Merriam-Webster. *Merriam-Webster's Collegiate Dictionary*. Eleventh Edition. Springfield, Massachusetts: Merriam-Webster, Incorporated. 2003.
- Miyagawa, K.F. *Permeability of Granular Subbase Materials*. Iowa: Interim Report for MLR-90-4, Iowa Department of Transportation. 1991.
- Moulton, L.K. and K.R. Seals. *Determination of the In-situ Permeability of Base and Subbase Courses*. Morgantown, West Virginia: Report No. FHWA-RD-79-88, Department of Civil Engineering, West Virginia University. 1979.
- Moulton, L.K. *Highway Subdrainage Design*. Washington, DC: Report No. FHWA-TS-80-244, Federal Highway Administration. 1980.
- National Stone Association. *Aggregate Hand Book*. Washington, DC: National Stone Association. 1996.

Pavement Technology Workshop. *A Video Tape from the South Africa/United States Pavement Technology Workshop*. Richmond, California: University of California, Berkeley Filed Station. 2000.

Thornton, S.I. and C.T. Leong. *Permeability of Pavement Base Course*. Fayetteville, Arkansas: Arkansas Highway and Transportation Department, and Mack-Blackwell National Rural Transportation Study Center, Department of Civil Engineering. 1995.

White, D. J., C. Jähren, and P. Vennapusa. *Determination of the Optimum Base Characteristics for Pavements*. Iowa: Report No. TR-482, Iowa Department of Transportation. 2004.

Yang, Huang H. *Pavement Analysis and Design*. Second Edition. New Jersey: 334-364, Pearson Prentice Hall. 2004.

Subsurface Drainage Systems

A. General Information

Subsurface drainage is a key element in the design of pavement systems. Indiscriminate exclusion of this element will assuredly lead to the premature failure of pavement systems, thereby resulting in high life-cycle costs. Faulting and associated pumping in rigid pavements systems, extensive cracking from loss of subgrade support in flexible pavements, and distress from frost heave are clear signs of inadequate drainage. The two basic design strategies promoted are to (1) prevent water from entering in the first place and (2) quickly remove any water that does infiltrate. After years of unsuccessful sealing attempts, the profession has learned that we cannot prevent water from entering a pavement and that removal of water is essential for the pavement elements to perform as desired (Christopher and McGuffey 1997).

Proper drainage cannot be overstressed in road construction. Water affects the entire serviceability of a road. In general, Iowa soils are fine-grained with low permeability. Coupled with a wet climate, if there is no subsurface drainage in pavement construction, the subgrade and subbase can be saturated for long periods. Starting from the bottom up, subsurface drainage may be the most important factor contributing to the longevity of a pavement section. Water in the subgrade and subbase weakens the support provided to the pavement. Maintaining the integrity of the subgrade and subbase can be accomplished through subsurface drainage and separation of the subbase from the subgrade using geotextiles.

Urban pavements with curbs are generally designed to direct surface stormwater within the right-of-way and adjacent property toward the pavement, where it is intercepted and transported by a system of stormwater intakes and pipes. This encourages the introduction of additional subsurface and surface water to the pavement system. Footing drains for adjacent structures may drain to this storm sewer system, a specially-constructed footing drain collector, or a combination subdrain/footing drain collector.

Proper surface drainage can reduce the amount of water infiltrating through the pavement and is a strategy that goes hand in hand with proper subsurface drainage. Most free water will enter the pavement through joints, cracks, and pores in the surface of the pavement. Water also will enter from backup in ditches and groundwater sources. Drainage prevents the buildup of free water in the pavement section, thereby reducing the damaging effects of load and environment. Based on documented case histories, studies have shown that pavement life can be extended up to three times if adequate subsurface drainage systems are installed and maintained (Cedergren 1989).

The importance and design of subgrade and subbase drainage is discussed in [Section 6E-1 - Subgrade Design and Construction](#), and [Section 6F-1 - Pavement Subbase Design and Construction](#). Generally, Iowa's soils are fine-grained and will have low permeability as indicated in the state permeability map shown in Figure 6G-1.01. Most subgrade soils in Iowa have poor drainage quality by AASHTO standards, less than 10 feet per day (< 5 inches/hour). Coupled with the fact that Iowa receives over 20 inches of precipitation a year and is considered a wet climate, subgrades and subbases can be saturated for long periods if subsurface drainage is not accommodated in pavement system construction. Subdrain systems, specifically designed to drain subsurface water, are a solution to remove water from permeable subbases and drainable subgrades. The advantage of a functional subsurface pavement drainage system will vary based on climate, subgrade soils, and the design of

overall pavement system.

Figure 6G-1.01: Permeability of Iowa Soils

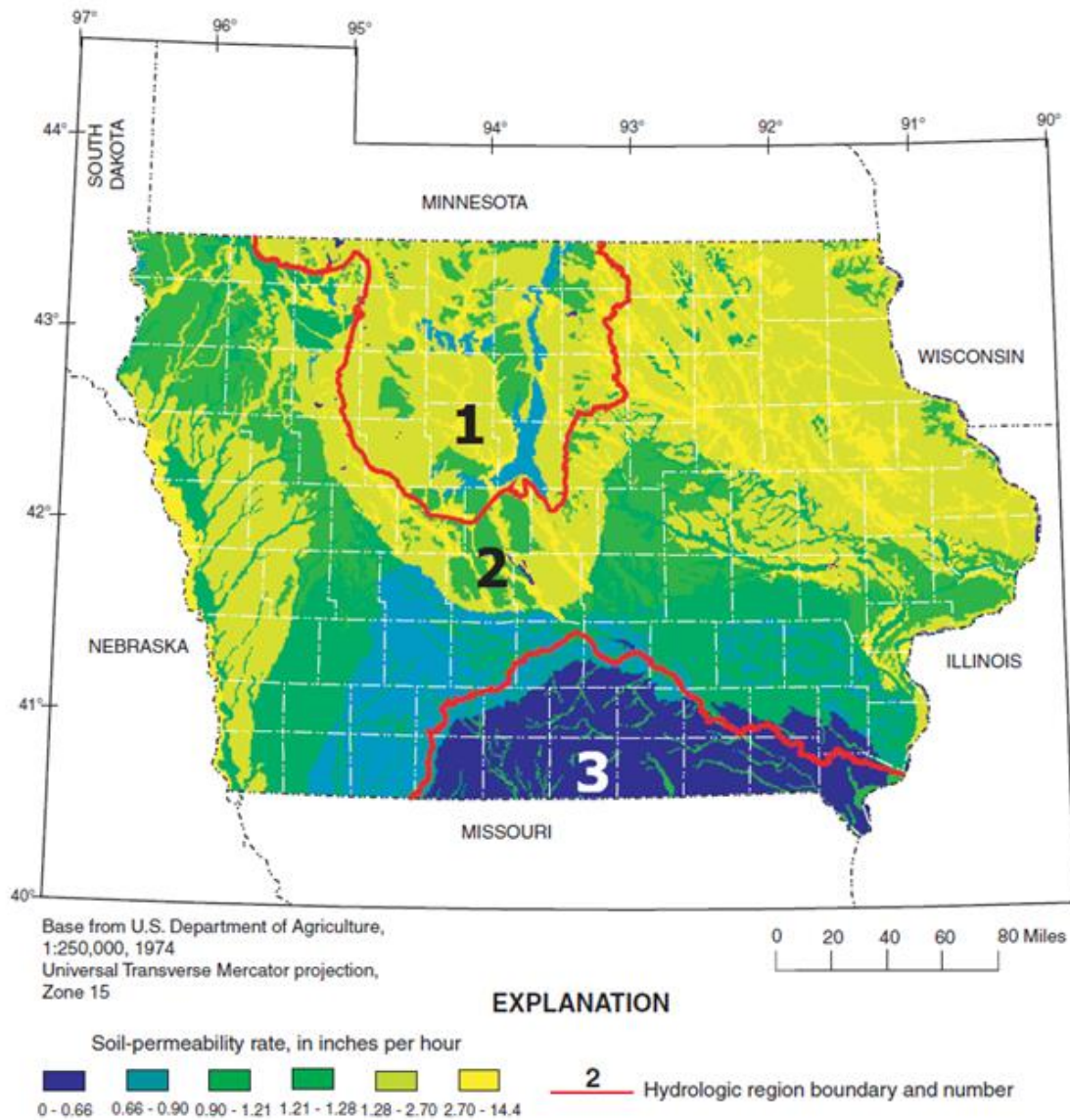

Source: Eash 2001

Unless a subsurface exploration determines subsurface drainage systems are not necessary, they should be installed for most paving projects in Iowa. A successful drainage design process must adequately and consistently address the following:

- Evaluation of the need for subdrainage.
- Determination of the necessary subdrainage components for the given situation.
- The hydraulic and structural design of subsurface drainage systems and their integration into the overall pavement design process.
- Property specifications of drainage materials for achieving long-term performance.
- Documentation of special construction and maintenance considerations.

B. Need for Subsurface Drainage

The damaging effects of excess moisture on pavement have long been recognized. Moisture from a variety of sources can enter a pavement structure. Figure 6G-1.02 shows that moisture in the subgrade and pavement structure can come from many different sources. Water may seep upward from a high ground water table, or it may flow laterally from the pavement edges. Knowledge of ground water and its movement are critical to the performance of pavement as well as the stability of adjacent sideslopes. Ground water can be particularly troublesome for pavements in low-lying areas. When pavements are constructed below the permanent or a seasonally high water table, drainage systems must perform or rapid pavement failure will occur. This moisture, when combined with traffic loads, voids in pavement sections, and freezing temperatures, can have a negative effect on both material properties and overall performance of a pavement system.

The most significant source of excess water in pavements is typically infiltration through the surface through joints, cracks, and other defects in the surface that provide an easy path for water. The problem only worsens with time. As pavements age and deteriorate, cracks become wider and more abundant and joints and edges deteriorate into channels through which water is free to flow. The result is more water being allowed into the pavement structure with increasing age, which leads to accelerated development of moisture-related distresses and pavement deterioration. Excess moisture in a pavement structure can adversely affect pavement performance. While a pavement structure can be stable at given moisture contents, the pavement structure may become unstable if the materials become saturated. High water pressures can develop under traffic loads. Water in the pavement structure can freeze and expand, developing high internal pressures on the pavement structure. Flowing water can carry soil particles and lead to clogging of drains and, in combination with traffic, lead to pumping of fines from the subbase or the subgrade.

Figure 6G-1.02: Sources of Moisture in Pavement Systems

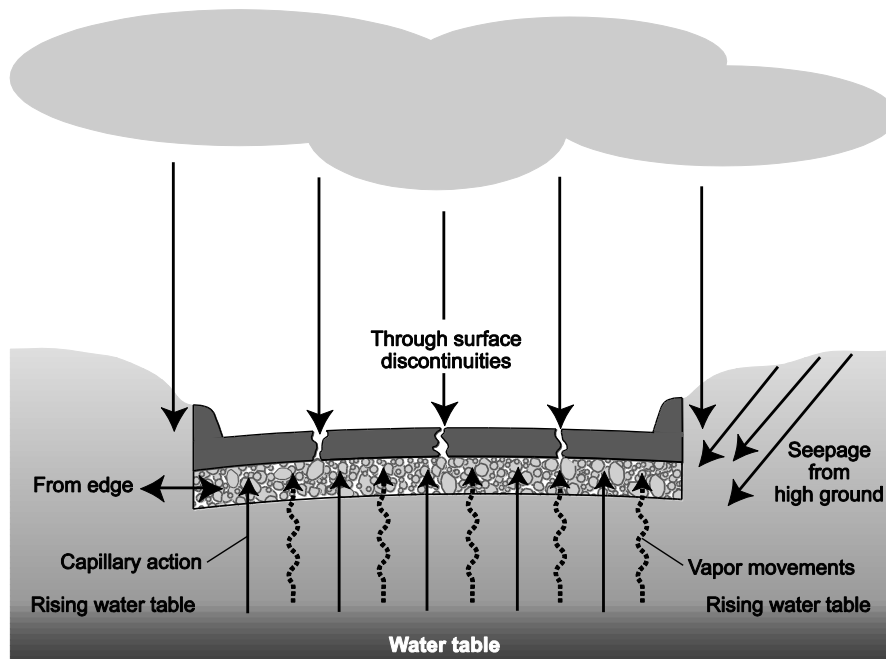

Source: Based on FHWA-NHI 2004

C. Types of Drainage Systems

To avoid moisture-related problems, a major objective in pavement design should be to keep the subgrade, subbase, and pavement structure from becoming saturated or exposed to high moisture levels. Three approaches exist for controlling or reducing the problems caused by moisture:

1. Prevent moisture from entering the pavement system
2. Use materials and design features that are insensitive to the effects of moisture
3. Quickly remove moisture that enters the pavement system.

No single approach can completely negate the effects of moisture on the pavement system over a period of many years. It is practically impossible to effectively seal the pavement from water intrusion. While materials that resist moisture can be incorporated, this is often not cost effective and in many cases such materials are simply not available locally. Indeed, subgrades that are susceptible to moisture deterioration cannot easily or cost effectively be replaced. Thus, the need for drainage systems that can quickly and effectively remove water from the pavement system is necessary.

Positive drainage can be affected with three elements:

1. Subbase to provide rapid drainage of free water that may enter the pavement structure.
2. Longitudinal subdrain collector system to convey accumulated water from the subbase.
3. Filter-separator layer to prevent the migration of fines (minus 200 sieve material) into the subbase from the subgrade (see Figure 6G-1.03, Cases A and C).

Unrestricted flow to the subbase must be ensured. The filter-separator layer, whether aggregate or geotextile, must be properly designed to prevent migration of fines and possible base contamination. Since many existing pavements have been designed and constructed with impermeable subgrades, rapid lateral drainage from the base of these rehabilitated pavement sections is not feasible. Here, retrofit with longitudinal subdrains can affect drainage of water that has infiltrated the pavement structure and migrated to the slab/subgrade interface. Subdrains placed adjacent to the pavement can intercept this water and shorten the time it is present at the interface, thereby minimizing the potential degradation effects (see Figure 6G-1.03, Case B).

Generally, footing drains for adjacent structures may drain to a storm sewer system or a combination subdrain/footing drain collector. However, a combination subdrain/footing drain collector, as shown in Figure 6G-1.03, Cases D and E, may be installed to serve both purposes. See [Chapter 2 - Stormwater](#), for guidance on sizing of footing drain collectors; normally pipe sizes range from 8 to 12 inches in diameter.

Figure 6G-1.03: Subdrains
 (SUDAS Specifications Figure 4040.231)

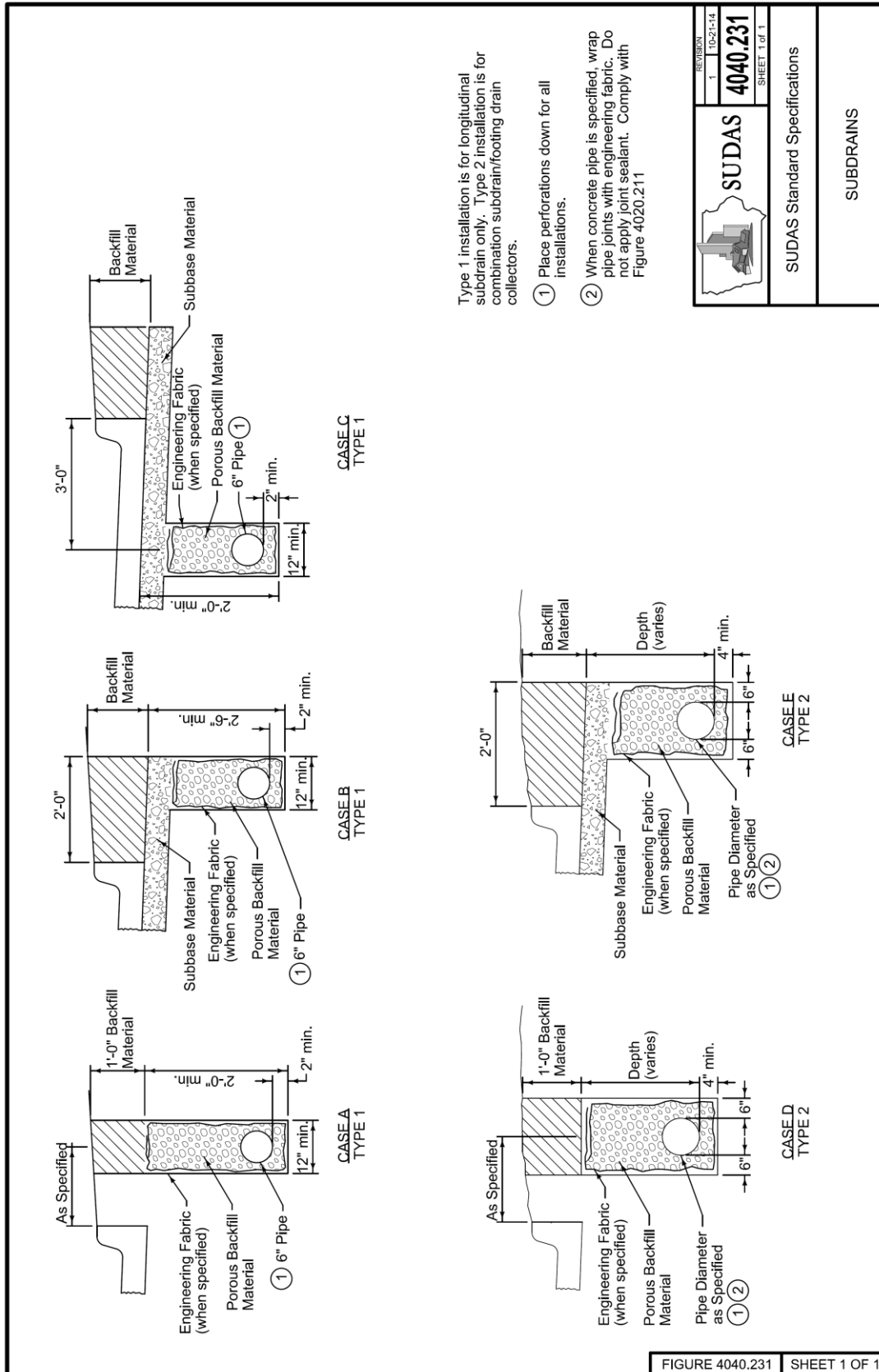

Type 1 installation is for longitudinal subdrain only. Type 2 installation is for combination subdrain/footing drain collectors.

- 1 Place perforations down for all installations.
- 2 When concrete pipe is specified, wrap pipe joints with engineering fabric. Do not apply joint sealant. Comply with Figure 4020.211

D. Design

Design of subsurface pavement drainage systems consists of balancing permeability and stability and removing collected water rapidly. Important components consist of subbase material, a separating layer to prevent infiltration of subgrade materials into the subbase, and a collection and removal system. Design approaches for each of the components are summarized below.

- 1. Subbase:** For the design of subbases, see [Section 6F-1 - Pavement Subbase Design and Construction](#). One of the purposes of the subbase is to remove infiltration water. The subbase should consist of durable, crushed, angular aggregate with the best porosity so that it will release the maximum amount of water. However, the structural requirements for the overall pavement section must be met using appropriate pavement design practices. The subbase can be stabilized or unstabilized. Effective subbase design must address structural, hydraulic, material durability and quality, constructability, and maintenance requirements.

Hydraulic requirements must be addressed for specific project conditions; however, the time period that free water is present within the pavement structure should be minimized, preferably less than 2 hours following end of precipitation. To maintain positive flow through the base, the road section should be sloped as much as possible, with a minimum cross slope of 2%. The highest permeability materials are unstable under construction traffic; therefore, it is desirable to use a more stable material with a lower permeability, such as 150 to 350 feet per day (75 to 175 inches per hour).

FHWA (1992) guidelines indicate that the quality of crushed aggregates is the single most important factor for the stability of a subbase. Breakdown of the aggregate could cause both loss of support and a decrease in permeability. Los Angeles Abrasion Wear should not exceed 50%, and aggregate soundness loss should not exceed the requirements for a Class B aggregate as specified by AASHTO M 283 (i.e., 12% for sodium sulfate test or 18% for magnesium sulfate test).

To enable proper construction of subbases, several construction guidelines have been proposed (Christopher and McGuffey 1997). Unstabilized materials generally are used in thicknesses of 4 inches or more. Asphalt and cement stabilized materials can be built as thin as 2 inches, however, 4 inches is recommended as a minimum. Material gradations vary widely; see White et al. (2004) for a review.

Of the subbase materials included in [SUDAS Specifications Section 2010](#), only granular subbase and modified subbase will provide adequate permeability. Granular subbase provides the highest permeability, however it is generally unstable under construction traffic. Modified subbase provides both stability and good permeability.

- 2. Separator/Filter Layers:** There is usually a need for a separator/filter layer between the subbase and the subgrade. Filtration compatibility of the subbase must be evaluated with respect to both the subgrade and the subbase to prevent migration of the subgrade into the subbase.

Geotextiles are commonly used as separators/filters. The FHWA geosynthetics manual (Holtz et al. 1995) provides guidelines on design procedures. Care must be exercised in the amount of cover material over geotextiles as there is potential for damage from equipment. Normally, 6 inches is considered the minimum thickness when earthmoving equipment is used for placement.

Dense-graded (low permeability) subbase can be placed below the permeable subbase and provide adequate separation. Filter criteria need to be checked for impermeable subbase materials that will be adjacent to the permeable subbase.

3. Subdrains:

- a. **New Construction:** Subdrains for new construction generally consist of pipe in a trench lined with non-woven geotextile (engineering fabric) and filled with aggregate. Typical installation sections are shown in Figure 6G-1.03, Cases B, C, and E. Design of subdrains for new construction and major reconstruction projects consists of ensuring that the trench backfill and subdrain pipe have the capacity to handle the design flow from the subbase.

The size of pipe is often based on maintenance requirements for cleaning capabilities and reasonable distance between outlets. Although FHWA recommends a minimum pipe diameter of four inches, the SUDAS Specifications require a minimum of 6 inch diameter pipe for Type 1 subdrain installations and a minimum of eight inch diameter pipe for Type 2 combination subdrain/footing drain collectors. The larger diameter subdrain pipe allows for additional capacity, easier cleaning, and inspection. Cleanouts are required for all Type 2 subdrains, at the end of line or at 300 feet spacings. For exceptionally long Type 1 installations, greater than 300 feet from an outlet, consideration should be given to providing cleanouts as required for Type 2 subdrains.

Trench backfill aggregate could be the same as the subbase or a material with greater permeability. AASHTO No. 57 stone, [Iowa DOT Gradation No. 3](#) has been used for trench backfill. The [SUDAS Specifications Section 3010](#) requires porous backfill to comply with [Iowa DOT Gradation No. 29](#) or the use of commercially available pea gravel. The non-woven geotextile used to line the subdrain trench must be designed as a filter, considering both the subbase and subgrade soils. The geotextile should not be extended between the interface of the subbase and the trench backfill aggregate because it may form a barrier. Also, geotextile should not be wrapped around the perforated drainage pipe.

One of the most critical items for subdrains is the grade of the invert. Construction control of very flat grades usually is not possible, leaving ponding areas that result in subgrade weakening and premature failures. It may be necessary to raise the pavement grade to develop adequate drain slopes for the subsurface drainage facilities. To achieve a desirable drainage capacity, a minimum slope that is greater than the slope of the road may be required for the subdrain, although this is often not practical and the pipe will mostly be sloped the same as the roadway. When adequate slopes cannot be achieved, rigorous maintenance should be anticipated.

The outlet for the subdrain must be low and large enough so that flow from the subdrain does not back up. FHWA recommends that the outlet pipe be at least 6 inches above the 10-year storm flow line of the ditch or hydraulic structure into which the outlet is flowing.

The designed drain trench and backfill must be constructible with normal construction equipment. Construction of subdrains is time-consuming. Care must be taken so that the trench backfill does not become contaminated with adjacent soil that might clog the drainage capacity.

- b. **Retrofit Subdrains:** A majority of pavement distress problems are related to excess moisture in the pavement structure. Retrofit subdrains can be used in rehabilitation projects to remove water. The design of retrofit subdrains is substantially different than new construction. Subdrains should be just one of the methods to consider to correct water problems. The principles for the design of retrofit subdrains apply to both HMA and PCC pavements. For the design of retrofit subdrains, the designer is referred to the Concrete Pavement Preservation Guide, 2nd Edition (National Concrete Pavement Technology Center, September 2014) and the Material Subsurface Pavement Drainage Manual (Idaho Transportation Department, 2007).

- c. **Geocomposite Subdrains:** Prefabricated, geocomposite subdrains (PGEDs) have recently been in high use and have been found to be very effective in removing water, with drainage rates equal to or better than pipe drains. Although many states have found PGEDs to be cost effective for retrofit applications, problems of clogging and intrusion of fines and buckling during construction have somewhat limited their use. Design considerations for PGEDs are detailed in NCHRP Report 367 (Koerner et al. 1994).

E. Construction Issues

Construction decisions and actions can have a significant impact on the performance of the pavement section. The design and construction groups must consider (1) each phase of construction, including subgrade preparation, placement of separation/filtration layers, construction of drains, placement of subbase, and construction of the pavement section; and (2) how the decisions of one group will affect the actions and decisions of the other group.

In the design phase, the designer must be concerned with how construction details, sequencing of work, site accessibility, and protection of drainage components will integrate with both the methods and equipment that can be used for pavement and drainage facility construction. Design decisions such as location of collector pipes and outlets, temporary and permanent surface drainage, and aesthetic treatments will influence how construction can be conducted. Such decisions will affect the right-of-way required for construction of the drainage systems.

Sequencing is best left to the contractor unless there is a significant impact on the performance of the drainage system. An important construction related design consideration is pipe access at the upstream end of a segment so that inspection and maintenance flushing activities can take place.

One of the primary reasons for bringing construction personnel in at the design phase is to acquaint them with the impact of construction on design. Care exercised during construction of the designed section without compromising the effectiveness of the design is essential to the pavement's long-term performance. Key performance elements for construction personnel include the following (Christopher and McGuffey 1997).

- Good pavement starts with a good foundation. A stable platform is required for construction of the subbase.
 - Quality of aggregate and its ability to meet gradation requirements is essential for meeting expected design performance levels.
 - Awareness is needed concerning the fact that the introduction of fines into the subbase during construction could result in premature failure of the pavement.
 - Unstabilized base tends to displace under traffic loadings.
 - Too much compaction or fine grading can significantly reduce the expected permeability of the subbase.
1. **Subgrade Preparation:** The foundation/subgrade surfaces are required to be level, somewhat smooth, and constructed to required grades. On drainable pavement sections, constructing and maintaining required subsurface grades is essential to maintain positive drainage until the pavement is constructed. Local depressions resulting from soft areas or depressions from equipment trafficking can lead to ponding of water below the pavement structure and subsequent loss of foundation support.
 2. **Separator/Filter Layers:** For granular subbase separator/filter layers, the gradation of materials needs to be checked carefully against the design specifications. Materials that are more openly-graded than specified requirements may allow migration of fines through or from the subbase, which can contaminate the permeable layer. Good compaction of the separator/filter layer is

essential for placement of the subbase. The subbase should be observed for rutting during compaction and subsequent trafficking; surface rutting may be an indication of subgrade rutting, which requires immediate attention. Increasingly, geotextile separation/filter layers are being used. For these, material and certification should be checked against the design requirements to ensure that the proper materials have been received and are being use. In constructing geotextile separation or filter layer, a smooth subgrade surface is essential. Therefore, sharp rock protrusion and loose rocks should be removed to avoid damage to the geotextile.

3. **Subdrains:** Proper grade control is required for subdrains to be effective. Undulating lines are not acceptable because water will accumulate in depressed portions of the pipe. Good practice dictates that subdrains be properly connected to the subbase and the outlets. For maintenance purposes, outlet spacing is limited to 300 feet. Subdrains need to be properly connected to the permeable subbase and outlets. Outlets are required to be set at the proper grades, and ditch lines are graded according to drainage requirements. Subdrain lines should be carefully marked to avoid damage due to construction equipment. Therefore, subdrains can sometimes be constructed after pavement construction. In this case, temporary subdrains are required for the permeable subbase.
4. **Permeable Subbase Materials:** Unstabilized subbase material requires close control of material gradation and activities that might produce segregation of the material during placement.

Subbase materials are very susceptible to segregation during placement. Special care is needed to prevent fines from migrating into the material and clogging the system. The addition of 2% to 3% water by weight reduces the potential for segregation during hauling and placement.

Excessive compaction with heavy vibratory compactors is not recommended on subbases because of the potential for damage and reduced permeability. Adequate compaction may be achieved with lightweight vibratory compactors or smooth drum rollers because of the relatively narrow gradation range of subbase.

Care is required to protect the subbase from contamination from dirty equipment, adjacent backfilling operations, or erosion sediment. The subbase should not be allowed to be used as a haul road. Good practice dictates that traffic be minimized and restricted to low speeds with minimal turning. No equipment should be allowed on the permeable materials until the complete drainage of the base and subbase has been confirmed.

F. Maintenance

Maintenance of pavement subsurface drainage systems has been identified as essential to the long-term success of drainage systems and, subsequently, pavements. The most effective maintenance programs use a five-phase approach:

- Routine inspection and monitoring
- Routine preventive maintenance
- Spot detection of problems (occurrences)
- Repair
- Continued monitoring and feedback

Budget constraints have resulted in usually only two phases being conducted: spot detection and repair. Studies show that inspection in conjunction with preventative maintenance can be very cost effective with \$3 to \$4 return in benefits for every \$1 invested (Christopher and McGuffey 1997).

- 1. Inspection and Monitoring:** The inspection phase of maintenance provides important data on the effectiveness of drainage elements and the need for further maintenance. Inspection practices include visual inspection and effectiveness testing. Visual inspection consists of inventorying outflow during storm events and assessing outlet condition. Outflow inventories are generally qualitative (e.g., high, moderate, low, or no flow). Visual inspection can be enhanced through the use of video cameras. Effectiveness testing can provide a more quantitative assessment of performance through the use of post-storm event monitoring with bucket sampling or direct upstream inflow coupled with downstream outflow measurements.
- 2. Preventative Maintenance:** Preventative maintenance actions that promote good subsurface drainage system performance include: clean and seal joints and cracks, clean and verify the grade of outlet ditches, clean catch basins and other discharge points, and clean outlet screens and area around headwalls. Based on the results of the outlet inspection program, a routine outlet cleaning program should be implemented.
- 3. Repair:** It is generally accepted that once pavement damage from blocked subsurface drainage is visible, the damage is irreversible, and that pavement life has been shortened. For this reason, any problems observed, no matter how minor in appearance, should be addressed immediately to confine the problems to a localized area.
- 4. Continuous Monitoring and Feedback:** Monitoring is a continuous improvement process and improvements are achieved only through providing feedback to the design and construction groups. Thus maintenance should provide inspection results long with performance indicators to design and construction groups for review. Pavement management methodologies and maintenance strategies are reviewed in NCHRP Syntheses 222 and 223 (Zimmerman and ERES Consultants 1995 and Geoffroy 1996).

G. References

- Cedergren, H.R. *Seepage, Drainage and Flow Nets*. Third Edition. New York: John Wiley and Sons. 1989.
- Eash, D.A. *Techniques for Estimating Flood-Frequencies Discharges for Streams in Iowa*. Iowa City, Iowa: Iowa Department of Transportation and the Iowa Highway Research Board. 2001.
- FHWA. *Demonstration Project 87: Drainable Pavement Systems, Participant Notebook*. Publication FHWA-SA-92-008, U.S. Department of Transportation. 1992.
- FHWA-NHI. *Geotechnical Aspects of Pavements*. Federal Highway Administration - National Highway Institute Course No. 132040. 2004.
- FHWA. *Technical Guide Paper on Subsurface Pavement Drainage*. Technical Paper 90-01, Federal Highway Administration, Office of Engineering, Pavement Division. 1990.
- Geoffroy, D.N. *NCHRP Synthesis of Highway Practice 223: Cost-Effective Preventative Maintenance*. Washington, DC: Transportation Research Board, National Research Council. 1996.
- Holtz, R.D., B.R. Christopher, and R.R. Berg. *Geosynthetic Design and Construction Guidelines*. Publication HI-95-038, Federal Highway Administration, U.S. Department of Transportation. 1995.
- Idaho Transportation Department (ITD). *Materials Subsurface Pavement Drainage Manual*. Section 550: Subsurface Pavement Drainage. Idaho Transportation Department, Boise, ID. 2007.

Koerner, R.M., G.R. Koerner, A.K. Fahim, and Wilson-Fahmy. *NCHRP Report 367: Long-Term Performance of Geosynthetics in Drainage Applications*. Washington, DC: Transportation Research Board, National Research Council. 1994.

Smith, K. and Harrington, D. *Concrete Pavement Preservation Guide, Second Edition*. Report No. FHWA-HIF-14-014, Federal Highway Administration. 2014.

White, D.J., C. Jahren, and P. Vennapusa. *Determination of Optimum Base Characteristics for Pavements*. Iowa: Report No. TR-482, Iowa Department of Transportation. 1994.

Zimmerman, K.A. and ERES Consultants, Inc. *NCHRP Synthesis of Practice 222: Pavement Management Methodologies to Select Projects and Recommend Preservation Treatments*. Washington, DC: Transportation Research Board, National Research Council. 1995.

Foundation Improvement and Stabilization

A. General Information

Soft subgrade and moisture-sensitive soils such as expansive soils, frost-prone soils, and collapsing soils present a construction challenge as well as a pavement performance challenge. Proper treatment of problem soils and the preparation of the foundation are important to ensure a long-lasting pavement structure that does not require excessive maintenance. Such soils can be stabilized to form a construction pad or a long-term subsurface layer capable of carrying pavement applied loads. In all cases, the provision for a uniform soil relative to textural classification, moisture, and density in the upper portion of the subgrade cannot be over emphasized. This uniformity can be achieved through soil sub-cutting or other techniques. Five techniques can be used to improve the strength and reduce the climatic variation of the foundation on pavement performance: stabilization of weak or moisture-sensitive soils, thick granular layers, subsurface drainage systems, geosynthetics, and soil encapsulation. Thick granular layers are generally greater than 18 inches in thickness and require readily accessible, good quality aggregates. Therefore, thick granular layers are seldom used in Iowa and will not be discussed further in this section.

B. Stabilization

Soil that is highly susceptible to volume and strength changes can cause severe roughness and accelerate the deterioration of the pavement structure in the form of increased cracking and decreased ride quality when combined with truck traffic. Generally, the strength and stiffness of some soils are highly dependent on moisture and stress state. In some cases, the subgrade soil can be treated with various materials to improve the strength and stiffness characteristics of the soil. Stabilization of soils is usually performed for two reasons:

1. As a construction foundation to dry very wet soils and facilitate compaction of the upper layers. In this case, the stabilized soil is usually not considered as a structural layer in the pavement design process. This process is also sometimes referred to as soil modification.
2. To strengthen a weak soil and restrict the volume change potential of a highly plastic or compressible soil. In this case, the stabilized soil is usually given some structural value in the pavement design process.

Lime, fly ash, cement, and asphalt stabilization have been used for controlling the swelling and frost heave of soils and improving the strength characteristics of unsuitable soils. For stabilization or modification of cohesive soils, hydrated lime is most widely used. Lime modification is used in many areas of the U.S. to obtain a good construction foundation in wet weather above highly plastic clays and other fine-grained soils. Lime is applicable in clayey soils (i.e., CH and CL type soils) and in granular soils containing clay binder (i.e., GC and SC), while Portland cement is more commonly used in non-plastic soils. Lime reduces the Plasticity Index (PI) and renders a clay soil less sensitive to moisture changes. The use of lime should be considered whenever the PI of the soil is greater than 10. It is important to note that changing the physical properties of a soil through chemical stabilization can produce a soil that is susceptible to frost heave.

Some basic definitions of soil modification and stabilization using lime, cement, and asphalt are provided below. Additional guidance on how stabilization is achieved using lime, cement, and asphalt can be found in TRB 1987; PCA 1995; and AI MS19, respectively. A flow chart for the determination of chemical treatment options for soil stabilization based on the percent passing the No. 200 sieve and the plasticity index of the soil is shown in Figure 6H-1.01.

Figure 6H-1.01: Selection of Stabilizer

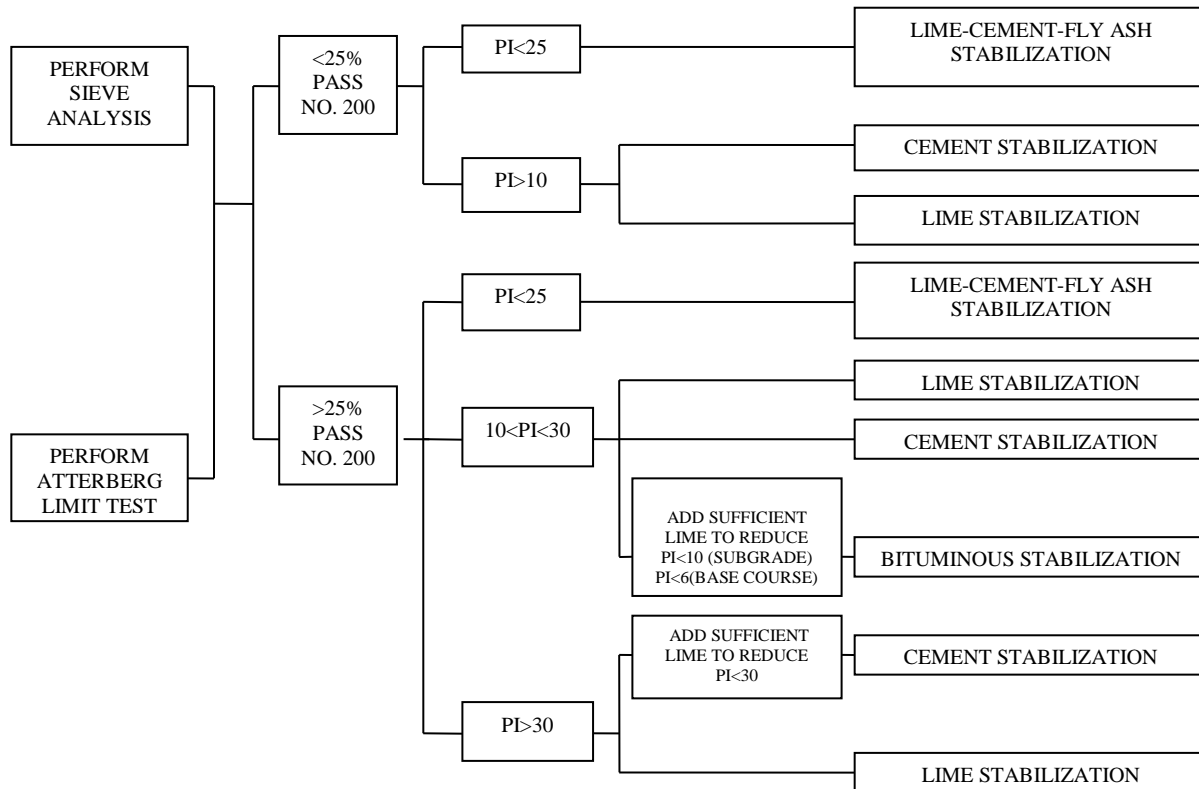

Source: U.S. Department of Transportation 1976

- a. **Lime Treatment:** Lime treatment or modification consists of the application of 1 to 3% hydrated lime to aid drying of the soil and permit compaction. As such, it is useful in the construction of a working foundation to expedite construction. Lime modification may also be considered to condition a soil for follow-up stabilization with cement or asphalt. Lime treatment of subgrade soils is intended to expedite construction, and no reduction in the required pavement thickness should be made.
- b. **Lime Stabilization:** Lime stabilization of soils improves the strength characteristics and changes the chemical composition of some soils. The strength of fine-grained soils can be improved significantly with lime stabilization, while the strength of coarse-grained soils is usually moderately improved. Lime has been found most effective with highly plastic clay soils containing montmorillonite (expansive clay mineral).

Lime stabilization has been found to be an effective method to reduce the volume change potential of many soils. However, lime treatment of soils can convert soil that shows negligible-to-moderate frost heave potential into a soil that is highly susceptible to frost heave, acquiring characteristics more typically associated with silts. It has been reported that this adverse effect has been caused by an insufficient curing period accompanied by an inadequate compaction effort. Adequate curing is also important if the strength

characteristics of the soil are to be improved.

For successful lime stabilization of clay (or other highly plastic) soils, the lime content should be from 3 to 8% of the dry weight of the soil, and the cured mass should have an unconfined compressive strength increase of at least 50 psi after a 28 day curing period over the uncured material. The optimum lime content should be determined with the use of unconfined compressive strength and the Atterberg limits tests on laboratory lime-soil mixtures molded at varying percentages of lime. The lime-stabilized subgrade layer should be compacted to a minimum density of 95%, as defined by Standard Proctor density. The minimum strength requirement for this material is a function of pavement type and the importance of the layer within the pavement structure.

When soils are treated properly with lime, it has been observed that the lime-soil mixture may be subject to durability problems caused by the cyclic freezing and thawing of the soil.

Lime-fly ash stabilization is applicable to a broader range of soils because the cementing action of the material is less dependent on the fines contained within the soil. However, long-term durability studies of pavements with lime-fly ash stabilization are rather limited.

Soils classified as CH, CL, MH, ML, SM, SC, and GC with a plasticity index greater than 10 and with at least 25% passing the No. 200 sieve potentially are suitable for stabilization with lime. Hydrated lime, in powder form or mixed with water as slurry, is used most often for stabilization. Figure 6H-1.02 can be used to estimate the design lime content for a subgrade. The quantities found from this chart should be used as a guideline, and laboratory testing mix design studies should be conducted for specific applications. Additional information can be obtained in the National Lime Association's Lime Stabilization Construction Manual (1972).

Figure 6H-1.02: Recommended Amounts of Lime for Stabilization of Subgrade and Bases

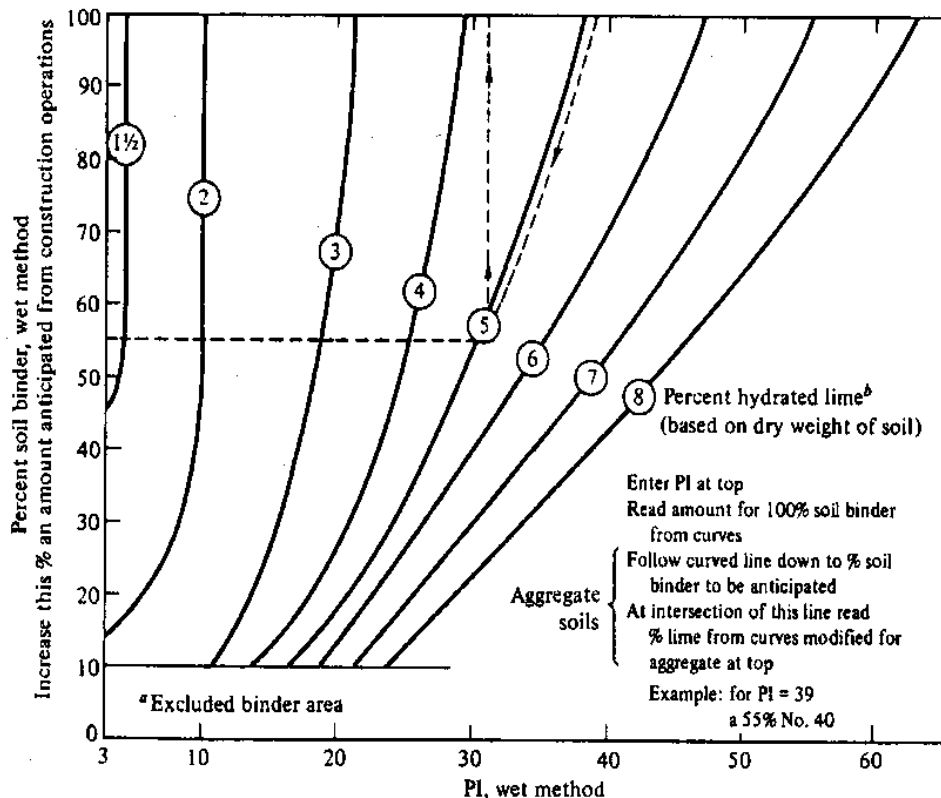

Source: National Lime Association 1972

- a. Cement Stabilization:** Portland cement is used widely for stabilizing low-plasticity clays, sandy soils, and granular soils to improve the engineering properties of strength and stiffness. Increasing the cement content increases the quality of the mixture. At low cement contents, the product is generally termed cement-modified soil. A cement-modified soil has improved properties of reduced plasticity or expansive characteristics and reduced frost susceptibility. At higher cement contents, the end product is termed soil-cement. Higher cement contents will unavoidably induce higher incidences of shrinkage cracking caused by moisture/temperature changes.

For soils to be stabilized with cement, proper mixing requires that the soil have a PI of less than 20 and a minimum of 45% passing the No. 40 sieve. However, highly plastic clays that have been pre-treated with lime or fly ash are sometimes suitable for subsequent treatment. For cement stabilization of granular and/or non-plastic soils, the cement content should be 3 to 10% of the dry weight of the soil, and the cured material should have an unconfined compressive strength of at least 150 psi within seven days. The Portland cement should meet the minimum requirements of AASHTO M 85. The cement-stabilized subgrade should be compacted to a minimum density of 95%, as defined by AASHTO T 134. Only fine-grained soils can be treated effectively with lime for marginal strength improvement.

- b. Asphalt Stabilization:** Generally, asphalt-stabilized soils are used for subbase construction. Use of asphalt as a stabilizing agent produces different effects, depending on the soil, and may be divided into three major groups:
- 1) Sand-asphalt, which produces strength in cohesionless soils, such as clean sands, or acts as a binder or cementing agent
 - 2) Soil-asphalt, which stabilizes the moisture content of cohesive fine-grained soils
 - 3) Sand-gravel asphalt, which provides cohesive strength and waterproofs pit-run gravelly soils with inherent frictional strength. The durability of asphalt-stabilized mixtures generally can be assessed by measurement of their water absorption characteristics.
- c. Fly Ash Stabilization:** Fly ash and similar materials can be used in the stabilization of clay soils either in place of lime or cement or in combination with lime and cement. Generally, the use of fly ash and similar materials reduces the shrink-swell properties of the soils. Additionally, the act of drying the soil facilitates soil compaction. These materials are used with clay-type soils that are above the optimum water content.

- 3. Characteristics of Stabilized Soils:** The improvement of subgrade or unbound aggregate by application of a stabilizing agent is intended to cause the improvements outlined above. These improvements arise from several important mechanisms that must be considered and understood by the pavement designer. Subgrade stabilizing agents may fill or partially fill the voids between the soil particles. This reduces the permeability of the soil by increasing the tortuosity of the pathways for water to migrate through the soil. Reduction of permeability may be relied upon to create a waterproof surface to protect underlying, water-sensitive soils from the intrusion of surface water. This mechanism must be accompanied by other aspects of the geometric design into a comprehensive system. The reduction of void spaces may also tend to change the volume change under shear from a contractive to a dilative condition. The stabilizing agent also acts by binding the particles of soil together, adding cohesive shear strength, and increasing the difficulty with which particles can move into a denser packing under load. Particle binding serves to reduce swelling by resisting the tendency of particles to move apart. The particles may be bound together by the action of the stabilizing agent itself (as in the case of asphalt cement), or may be cemented by byproducts of chemical reactions between the soil and stabilizing agent (as in the case of lime or portland cement).

The zone that may be selected for improvement depends upon a number of factors. Among these are the depth of soft soil, anticipated traffic loads, the importance of the transportation network, and the drainage characteristics of the geometric design and the underlying soil. When only a thin zone is subject to improvement, removal and replacement will usually be the preferred alternative by most agencies, unless a suitable replacement soil is not economically available. The zone can be described as thick or thin, based primarily on the economics of the earthwork requirements and the depth of influence for the vehicle loads.

- 4. Pavement Design Considerations for Stabilized Subgrades:** The application of the stabilizing agent will usually increase the strength properties of the soil. This increase will generally appear in the pavement design process as an increase in the modulus of the improved soil, reducing the pavement structural layer thicknesses. The cost of the stabilization process, therefore, can be offset by savings in the pavement structural layers. However, it is important that the actual increase used in the design process be matched in the constructed product, making construction quality control and quality assurance programs very important. When pavement design is performed using only a single parameter to describe the subgrade condition, the thickness of the stabilized zone is a critical component in determining the increased modulus to use in design.

The thickness of the improved subgrade zone is both a design and a construction consideration. From the design standpoint, it would obviously be advantageous to stabilize and improve the properties of a zone as thick as may be reasonably stabilized. From a constructability perspective, there are practical and economic implications related to the thickness of the stabilized zone. Stabilization requires that the agent be thoroughly distributed into the soil matrix, and that the soil matrix must be well pulverized to prevent unimproved clumps from remaining isolated within the mass. The construction equipment used to mix must be capable of achieving high levels of uniformity throughout the depth of desired improvement. If the zone to be improved is very thick, it may be necessary to process the stabilized soil in multiple lifts, which will usually require the stripping and stockpiling of upper lifts within the subgrade. Stabilization therefore rarely exceeds a few inches in depth in transportation applications, except for deep mixing applications that might be used in the vicinity of bridge foundations or abutments to provide improved foundation support.

C. Subsurface Drainage

Subsurface drainage systems are used for three basic reasons:

- To lower the groundwater level
- To intercept the lateral flow of subsurface water beneath the pavement structure
- To remove the water that infiltrates the pavement's surface

Deep subdrains (below frost line) are usually installed to handle groundwater problems. The design and placement of these subdrains should be handled as part of the geotechnical investigation of the site. Edgedrains placed in trenches under the shoulders at shallower depths are used to handle water infiltrating the pavement from above. The design and placement of these drainage systems is discussed in [Section 6G-1 - Subsurface Drainage Systems](#).

D. Geosynthetics

Geosynthetics are a class of geomaterials that are used to improve soil conditions for a number of applications. They consist of manufactured polymeric materials used in contact with soil materials or pavements as an integral part of a man-made system (ASTM D 4439). The most common applications in general use are in pavement systems for both paved and unpaved roadways, for reinforcing embankments and foundation soils, for creating barriers to water flow in liners and cutoffs, and for improving drainage. The generic term “geosynthetic” is often used to cover a wide range of different materials, including geotextiles, geogrids, and geomembranes. Combinations of these materials in layered systems are usually called geocomposites.

1. Materials:

- a. **Geotextiles:** A geotextile, as defined by ASTM D 4439, is “a permeable geosynthetic comprised solely of textiles.” These materials are also known as engineering fabrics. Fabrics are usually created from polymers, most commonly polypropylene, but also potentially including polyester, polyethylene, or nylon (Koerner 1998). Geotextiles are usually classified by their manufacturing process as either woven or non-woven. Both kinds of geosynthetics use a polymer fiber as raw material. Depending on the application, the fibers may be used singly or spun into yarns by wrapping several fibers together, or created by a slit film process. Woven geosynthetics are manufactured by weaving fibers or yarns together in the same way as any form of textile, although generally only fairly simple weaving patterns are used. Non-woven geosynthetics are made by placing fibers in a bed, either in full-length or in short sections. The fibers are then bonded together, either by raising the temperature, applying an adhesive chemical, or by mechanical means (usually punching the bed of fabric with barbed needles, in essence, tangling them into a tight mat).
- b. **Geogrids:** Geogrids, as their name suggests, consist of a regular grid of plastic with large openings (called apertures) between the tensile elements. The function of the apertures is to allow the surrounding soil materials to interlock across the plane of the geogrid; hence, the selection of the size of the aperture is partially dependent on the gradation of the material into which it will be placed. The geogrid is manufactured using high-density polymers of higher stiffnesses than are common for geotextiles. These polymers are then punched in a regular pattern and drawn in one or two directions. Alternatively, a weaving process may be used in which the crossing fibers are left wide apart and the junctions between them are reinforced.
- c. **Geomembranes:** Geomembranes are used to retard or prevent fluid from penetrating the soil and as such consist of continuous sheets of low permeability materials. These materials are made by forming the polymer into a flat sheet, which may have a roughened surface created to aid in the performance of the membrane by increasing friction with the adjacent soil layer.

Several other kinds of geosynthetic materials may be made by slight variations of these general types. For example, geonets are similar in appearance to geogrids but are manufactured slightly differently so that the individual elements of the geonet are at acute angles to each other. These materials are usually used in drainage applications.

- d. **Geocomposites:** Geocomposite materials are often created by combining two or more of the specific types of products described previously to take advantage of multiple benefits. Further, geocomposites may be formed by combining geosynthetics with more traditional geomaterials, the most common example being the geosynthetic clay liner. A geosynthetic clay liner consists of a layer of bentonite sandwiched together with geomembrane or geotextile materials to create a very low permeability barrier.

2. **Applications:** There are six widely recognized functions for geosynthetic applications as shown across the top of Table 6H-1.01. The typical classes of geosynthetic used for each function are also shown. Although the table indicates only primary functions, most geosynthetic applications call for the material to satisfy at least one secondary function as well (e.g., a separation layer under a pavement may also be required to reinforce the subgrade and influence drainage under the pavement).

Table 6H-1.02 provides a summary of the most commonly used geosynthetic functions for transportation applications. Comparison of Tables 6H-1.01 and 6H-1.02 reveals that the geotextile and geogrid materials are the most commonly used in transportation, although certainly others are sometimes used. This generality is more accurate when only the pavement itself (not including the adjoining fill or cut slopes, retaining walls, abutments, or drainage facilities) is considered. The most common usage for geosynthetics in the United States has historically been for unpaved roads but use in paved, permanent roads is increasing.

Each of these functional classes, while potentially related by the specific application being proposed, refers to an individual mechanism for the improvement of the soil subgrade. The separation function describes the maintenance of materials of different gradations as separate and distinct materials. In the specific case of the pavement application, separation relates to the maintenance of unbound granular base course materials as distinct from the subgrade (Koerner 1998; Christopher and Holtz 1991).

These materials may tend to become mixed in service due to pumping of the subgrade into the subbase, or due to localized bearing capacity failures leading to migration of aggregate particles into the subgrade (TRB 1987). This potential behavior has been confirmed in the field, as well as the ability of geosynthetic materials to resist it (Macdonald and Baltzer 1997; McKeen 1976). Once the unbound subbase is mixed with the subgrade, its strength and drainage properties may be detrimentally affected.

Table 6H-1.01: Functions of Geosynthetic Materials

Geosynthetic Materials	Function					
	<i>Filtration</i>	<i>Drainage</i>	<i>Separation</i>	<i>Reinforcement</i>	<i>Fluid Barrier</i>	<i>Protection</i>
Geotextile	x	x	x	x		x
Geogrid			x	x		
Geomembrane					x	
Geonet		x				
Geocomposites:						
Geosynthetic Clay Liner					x	
Thin Film Geotextile Composite					x	
Field Coated Geotextile					x	

Source: Laguros and Miller 1997.

Table 6H-1.02: Transportation Uses of Geosynthetic Materials

Function	Specific Use
Filtration	<ul style="list-style-type: none"> • Beneath aggregate subbase for paved and unpaved roads and airfields or railroad ballast
Drainage	<ul style="list-style-type: none"> • Drainage interceptor for horizontal flow • Drain beneath other geosynthetic systems
Separation (of dissimilar materials)	<ul style="list-style-type: none"> • Between subgrade and aggregate subbase in paved and unpaved roads and airfields • Between subgrade and ballast for railroads • Between old and new asphalt layers
Reinforcement (of weak materials)	<ul style="list-style-type: none"> • Over soft soils for unpaved roads, paved roads, airfield, railroads, construction foundations

Source: Koerner 1998

- a. Reinforcement Function:** The reinforcement function is very similar to the reinforcement process in reinforced concrete elements. The geosynthetic is introduced to provide elements with tensile resistance into the unbound material, which on its own would exhibit very low tensile resistance. The specific improvements imparted to pavement designs include the potential for improved lateral restraint of the subbase and subgrade, modifications of bearing capacity failure surfaces, and tensile load transfer under the wheel load. The lateral restraint arises as the subbase material tends to move outward under load beneath the wheel. The geosynthetic tends to be pulled along as a result of friction or interlock with the aggregate particles, and resists that tendency through its own tensile strength. The particles are therefore held in place as well. Bearing capacity surfaces may be forced to remain above the geosynthetic, in the stronger base course. Finally, the tendency of the subbase to bend under the wheel loads introduces tensile stress at the subbase/subgrade interface, which may be taken by the geosynthetic. Careful consideration must be given to the mobilization behavior of the geosynthetic, which may require fairly large strains to provide the desired reinforcement.
- b. Filtration Function:** The filtration function is similar to the separation function, but in this case the reason for mixing or migration of particles is the seepage forces induced by water flowing through the unbound material. The function of the filter is to provide a means to allow water to flow through unbound material without excessive loss of soil due to seepage forces, and without clogging (Koerner 1998). Zonal filters may offer the same protection, but may be less convenient or practical to install. The drainage function is related to the filtration function, in that once again the desired behavior is the movement of water out of or through the unbound material with sufficient maintenance of the fine particles in place. The difference arises in the focus and intent; filtration applications tend to be predicated on the maintenance of the soil, while drainage applications tend to attach more importance to the quantity of flow to be maintained or the desired reduction in pore water pressure. Further, the drainage function may be carried out by designing for drainage along the plane of the geotextile itself, rather than through surrounding unbound material.

The specific function to be provided by the geosynthetic in transportation applications is a function of the soil conditions. Table 6H-1.03 indicates that the following functions most commonly arise as a function of the soil strength.

Table 6H-1.03: Function of the Geosynthetic vs. Subgrade Properties

S_u (kPa) ¹	CBR	Function
60-90	2-3	Filtration, some separation
30-60	1-2	Filtration, separation, some reinforcement
<30	Below 1	Filtration, separation, reinforcement

¹ S_u (kPa) = undrained shear strength (1 kPa = 20.89 psf)

Source: Holtz et al. 1998

The range of functions potentially served by the geosynthetic thus increases as the subgrade strength decreases. In all cases reported in Table 6H-1.03, the soil conditions are rather poor. Table 6H-1.04 indicates that geosynthetics are most appropriate under the conditions outlined.

Table 6H-1.04: Appropriate Conditions for Geosynthetic Use

Condition	Related Measures
Poor soils	USCS: SC, CL, CH, ML, MH, OH, or PT soils; or AASHTO: A-5, A-6, A-7, or A7-6 soils
Low strength	$S_u < 13$ kPa, CBR <3, or MR <4500 psi
High water table	Within zone of influence of surface soils
High sensitivity	High undisturbed strength compared to remolded strength

Source: Holtz et al. 1998

- Design Considerations:** Koerner describes three potential design approaches: design by cost, design by specification, and design by function, to design geosynthetics for engineering application. Additional information on these design approaches can be found in Koerner 1998.

E. Soil Encapsulation

Soil encapsulation is an embankment placement technique that has been used to protect moisture sensitive soils from large variations in moisture content. However, this technique is rarely used to improve the foundations of higher-volume roadways. It is more commonly used as a foundation or subbase layer for low-volume roadways, where the import of higher-quality embankment materials is restricted from a cost standpoint. The concept of soil encapsulation is to keep the fine-grained soils at or slightly below optimum moisture content, where the strength of these soils can support heavier trucks and traffic. See [Section 6D-1 - Embankment Construction](#), for placement of unsuitable soils within embankment sections.

F. Moisture Conditioning

Table 6H-1.05 shows the relationship between optimum moisture content and density/strength of Iowa soils. For gaining maximum dry density and better compressive strength of soil, the water content should be kept at or around optimum moisture content. The SUDAS Specifications require a moisture content between optimum and 4% above optimum moisture for prepared subgrades.

According to ASTM D 698 Method A, a wide range of maximum densities and optimum moisture contents were determined. Table 6H-1.05 shows the typical relationships between optimum moisture contents and density/strength of some Iowa soils.

Table 6H-1.05: Typical Optimum Moisture Contents and Density/Strengths

Soil	Optimum Moisture Content (%)	Maximum Dry Unit Weight γ_d , (pcf)	Unconfined Compressive Strength at Optimum Moisture Content (psi)
Paleosol	17.0	106.7	48
Alluvium	19.8	102.6	44
Glacial Till	12.5	118.4	44
Le Grand Loess	17.2	106.1	44
Turin Loess	16.6	105.2	33

Source: White, et al. 2005

G. Granular Subbases

Granular subbases are used as a substitute for subgrade materials in regions having poor soils (i.e., high moisture content fine-grained soils) when the subgrade is not treated with another chemical or mechanical stabilizer. The granular subbase provides additional load bearing strength directly below the pavement, reduces the stress applied to the subgrade, provides drainage for the pavement system, and provides a uniform, stable construction platform. See [Section 6F-1 - Pavement Subbase Design and Construction](#), for more information.

H. References

Asphalt Institute. *The Basic Emulsion Manual*. Third Edition. Lexington, KY: Manual Series No. 19. 2007.

Christopher, B.R., and R.D. Holtz. *Geotextiles for Subgrade Stabilization in Permanent Roads and Highways*. Atlanta, GA: Proceedings, Geosynthetics. 1991.

Holtz, R.D., B.R. Christopher, and R.R. Berg. *Geosynthetic Design and Construction Guideline*. Washington, DC: Participant Notebook, NHI Course No. 13213, Publication No. FHWA HI-95-038 (revised), Federal Highway Administration, Washington, D.C. 1998.

Koerner, R.M. *Designing with Geosynthetics*. Fourth Edition. Upper Saddle River, NJ: Prentice Hall. 1998.

Macdonald, R., and S. Baltzer. *Subgrade performance study part I: Materials, Construction and Instrumentation*. Denmark: Danish Road Institute. 1997.

McKeen, R.G. *Design and Construction of Airport Pavements on Expansive Soils*. Washington, DC: Report No. FAA-RD-76-66. 1976.

National Lime Association. *Lime Stabilization Construction Manual*. Fifth Edition. Washington, DC. 1972.

Portland Cement Association. *Soil-Cement Construction Handbook*. Skokie, IL. 1995.

Transportation Research Board. *Lime Stabilization – Reactions, Properties, Design, and Construction, State of the Art Report 5*. Washington, DC. 1987.

U.S. Department of Transportation. *Soil Stabilization in Pavement Structures, A Users Manual, Vol. 1*. 1976.

White, D., D. Harrington, and Z. Thomas. *Soil Stabilization of Non-uniform Subgrade Soils*. Iowa: Report No. TR-461, Iowa Department of Transportation. 2005.

Additional Resources:

Bergeson, K., C. Jahren, and D. White. *Embankment Quality Phase I*. Iowa: Report No. TR-401, Iowa Department of Transportation. 1998.

Christopher, B.R., and V.C. McGuffey. *Synthesis of Highway Practice 239: Pavement Subsurface Drainage Systems*. Washington, DC: National Cooperative Highway Research Program, Transportation Research Board, National Academy Press. 1997.

Laguros, J.G., and G.A. Miller. *Stabilization of Existing Subgrades to Improve Constructability During Interstate Pavement Reconstruction*. Washington, DC: NCHRP Synthesis 247, Transportation Research Board. 1997.

Newcomb, D.A., and B. Birgisson. *Measuring In Situ Mechanical Properties of Pavement Subgrade Soils*. Washington, DC: NCHRP Synthesis 278, Transportation Research Board. 1999.

Skok, E.L., E.N. Johnson, and M. Brown. *Special practices for design and construction of subgrades in poor, wet and/or saturated soil condition*. Minnesota: Report No. MN/RC-2003-36, Minnesota Department of Transportation. 2003.

Snethen, D.R., L.D. Johnson, and D.M. Patrick. *An Evaluation of Expedient Methodology for Identification of Potentially Expansive Soils*. Washington, DC: Report No. FHWA-RD-77-94. 1977.

U.S. Army Corps of Engineers. *Engineering and Design - Pavement Criteria for Seasonal Frost Conditions - Mobilization Construction*. Engineering Manual EM 1110-3-138. 1984.

White, D., K. Bergeson, and C. Jahren. *Embankment Quality: Phase II*. Iowa: Report No. TR-401, Iowa Department of Transportation. 2000.

White, D., K. Bergeson, and C. Jahren. *Embankment Quality: Phase III*. Report No. TR-401, Iowa Department of Transportation. 2002.

